

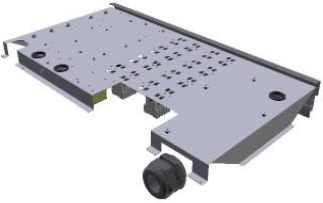





| Assembly code  | Assembly revision | Assembly image  |
|----------------|-------------------|---|
| ASM1809A/0.D01 | Electrical system |    |
| ASM1817A/0.D04 | Door              |    |
| ASM1800A/0.D02 | External cover    |   |
| ASM1804A/0.D02 | Cooking chamber   |  |

ASM1809A/0.D01 - Electrical system

FRONT

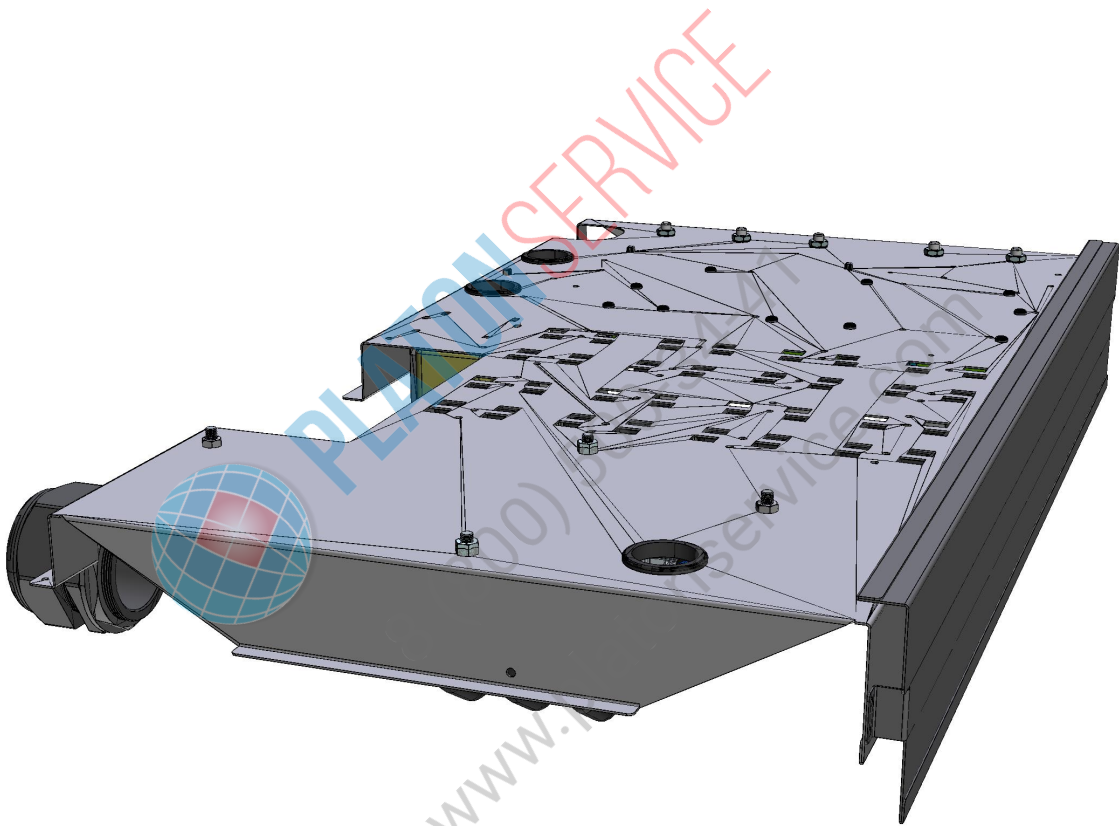

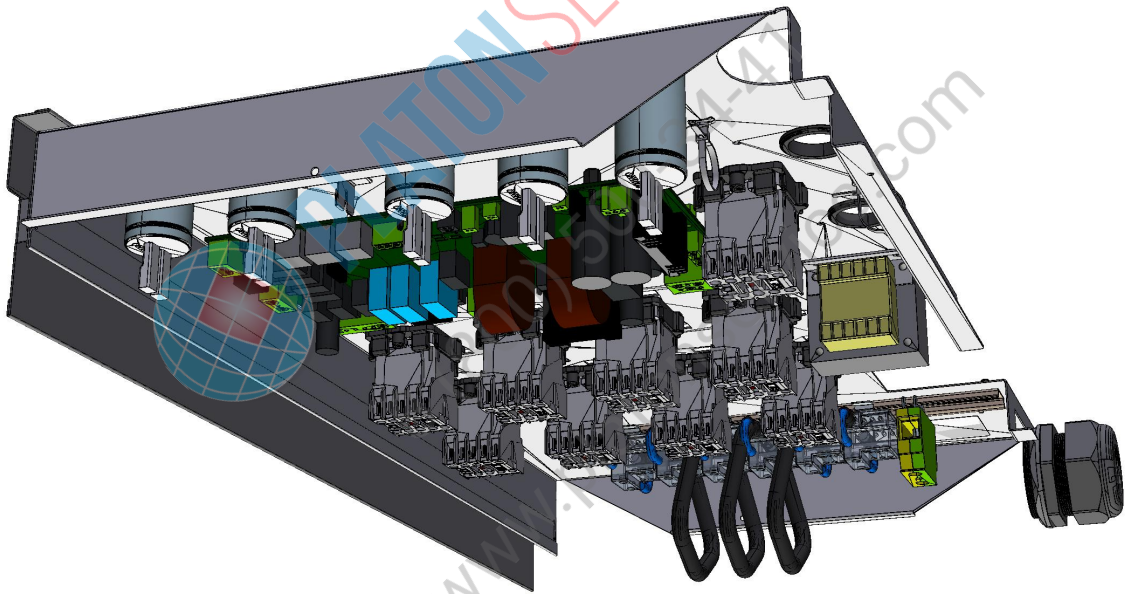

ASM1809A/0.D01 - Electrical system

REAR

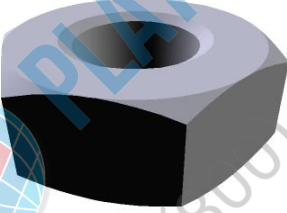

| COMPONENT |                                       |   | SPARE PART |  |   |      |             |     |     |          |                                       |   |    |          |                                     |   |    |          |                                     |   |    |
|-----------|---------------------------------------|---|------------|--|---|------|-------------|-----|-----|----------|---------------------------------------|---|----|----------|-------------------------------------|---|----|----------|-------------------------------------|---|----|
| Code      | Description                           | Image   | Code       | Description                              | Components list   |      |             |     |     |          |                                       |   |    |          |                                     |   |    |          |                                     |   |    |
| CN1003A   | 6,3 UF MOTOR CAPACITOR                |    | KCN1003A   | 6,3 UF MOTOR CAPACITOR KIT               | <table border="1"> <thead> <tr> <th>Code</th> <th>Description</th> <th>Qty</th> <th>UOM</th> </tr> </thead> <tbody> <tr> <td>CN1003A0</td> <td>6,3 UF MOTOR CAPACITOR</td> <td>1</td> <td>PZ</td> </tr> <tr> <td>VI1931A0</td> <td>M8 NUT+INDENTE D WASHER D=8 X COND.</td> <td>1</td> <td>PZ</td> </tr> <tr> <td>VI1932A0</td> <td>M8 NUT+INDENTE D WASHER D=8 X COND.</td> <td>1</td> <td>PZ</td> </tr> </tbody> </table> | Code | Description | Qty | UOM | CN1003A0 | 6,3 UF MOTOR CAPACITOR                | 1 | PZ | VI1931A0 | M8 NUT+INDENTE D WASHER D=8 X COND. | 1 | PZ | VI1932A0 | M8 NUT+INDENTE D WASHER D=8 X COND. | 1 | PZ |
| Code      | Description                           | Qty   | UOM        |  |   |      |             |     |     |          |                                       |   |    |          |                                     |   |    |          |                                     |   |    |
| CN1003A0  | 6,3 UF MOTOR CAPACITOR                | 1   | PZ         |  |   |      |             |     |     |          |                                       |   |    |          |                                     |   |    |          |                                     |   |    |
| VI1931A0  | M8 NUT+INDENTE D WASHER D=8 X COND.   | 1   | PZ         |  |   |      |             |     |     |          |                                       |   |    |          |                                     |   |    |          |                                     |   |    |
| VI1932A0  | M8 NUT+INDENTE D WASHER D=8 X COND.   | 1   | PZ         |  |   |      |             |     |     |          |                                       |   |    |          |                                     |   |    |          |                                     |   |    |
| VE1115A   | 20 A 230V 4 POLES MINICONTACTOR       |   | KVE1115A   | 20A 230V 4 POLES MINICONTACTOR KI        | <table border="1"> <thead> <tr> <th>Code</th> <th>Description</th> <th>Qty</th> <th>UOM</th> </tr> </thead> <tbody> <tr> <td>VE1115A0</td> <td>20 A 230V 4 POLES MINICONTACTOR</td> <td>1</td> <td>PZ</td> </tr> <tr> <td>VM1075A1</td> <td>PLASTIC CLIP TO FIX CONTACTORS</td> <td>4</td> <td>PZ</td> </tr> </tbody> </table>  | Code | Description | Qty | UOM | VE1115A0 | 20 A 230V 4 POLES MINICONTACTOR       | 1 | PZ | VM1075A1 | PLASTIC CLIP TO FIX CONTACTORS      | 4 | PZ |          |                                     |   |    |
| Code      | Description                           | Qty   | UOM        |  |   |      |             |     |     |          |                                       |   |    |          |                                     |   |    |          |                                     |   |    |
| VE1115A0  | 20 A 230V 4 POLES MINICONTACTOR       | 1   | PZ         |  |   |      |             |     |     |          |                                       |   |    |          |                                     |   |    |          |                                     |   |    |
| VM1075A1  | PLASTIC CLIP TO FIX CONTACTORS        | 4   | PZ         |  |   |      |             |     |     |          |                                       |   |    |          |                                     |   |    |          |                                     |   |    |
| VM1056A   | SMALL CONTACTOR BRACKET VE1115A       |  | VM1056A0   | SMALL CONTACTOR BRACKET VE1115A          |   |      |             |     |     |          |                                       |   |    |          |                                     |   |    |          |                                     |   |    |
| VE1644A   | PG 29 STRAIN RELIEF NUT               |  | VE1644A0   | PG 29 STRAIN RELIEF NUT                  |   |      |             |     |     |          |                                       |   |    |          |                                     |   |    |          |                                     |   |    |
| CE1420A   | 8 WAYS UNIPOLAR TERMINAL BLOCK Z16-8D |  | KCE1420A   | 8 WAY Z16-8D UNIPOLAR TERMINAL BOARD KIT | <table border="1"> <thead> <tr> <th>Code</th> <th>Description</th> <th>Qty</th> <th>UOM</th> </tr> </thead> <tbody> <tr> <td>CE1420A0</td> <td>8 WAYS UNIPOLAR TERMINAL BLOCK Z16-8D</td> <td>1</td> <td>PZ</td> </tr> </tbody> </table>  | Code | Description | Qty | UOM | CE1420A0 | 8 WAYS UNIPOLAR TERMINAL BLOCK Z16-8D | 1 | PZ |          |                                     |   |    |          |                                     |   |    |
| Code      | Description                           | Qty   | UOM        |  |   |      |             |     |     |          |                                       |   |    |          |                                     |   |    |          |                                     |   |    |
| CE1420A0  | 8 WAYS UNIPOLAR TERMINAL BLOCK Z16-8D | 1   | PZ         |  |   |      |             |     |     |          |                                       |   |    |          |                                     |   |    |          |                                     |   |    |

| COMPONENT |                                     |   | SPARE PART |                               |  |      |             |     |     |          |                          |   |    |          |                                |   |    |          |              |   |    |          |                                     |   |    |
|-----------|-------------------------------------|---|------------|-------------------------------|--|------|-------------|-----|-----|----------|--------------------------|---|----|----------|--------------------------------|---|----|----------|--------------|---|----|----------|-------------------------------------|---|----|
| Code      | Description                         | Image   | Code       | Description                   | Components list  |      |             |     |     |          |                          |   |    |          |                                |   |    |          |              |   |    |          |                                     |   |    |
| MR1011A   | UL 125A GROUND TERMINAL             |    | KMR1011A   | UL 125A GROUND TERMINAL KIT   | <table border="1"> <thead> <tr> <th>Code</th> <th>Description</th> <th>Qty</th> <th>UOM</th> </tr> </thead> <tbody> <tr> <td>MR1011A0</td> <td>UL 125A GROUND TERMINAL</td> <td>1</td> <td>PZ</td> </tr> </tbody> </table>   | Code | Description | Qty | UOM | MR1011A0 | UL 125A GROUND TERMINAL  | 1 | PZ |          |                                |   |    |          |              |   |    |          |                                     |   |    |
| Code      | Description                         | Qty   | UOM        |                               |  |      |             |     |     |          |                          |   |    |          |                                |   |    |          |              |   |    |          |                                     |   |    |
| MR1011A0  | UL 125A GROUND TERMINAL             | 1   | PZ         |                               |  |      |             |     |     |          |                          |   |    |          |                                |   |    |          |              |   |    |          |                                     |   |    |
| VE1628A   | REDUCED STRAIN RELIEF PG 48         |   | VE1628A0   | REDUCED STRAIN RELIEF PG 48   |  |      |             |     |     |          |                          |   |    |          |                                |   |    |          |              |   |    |          |                                     |   |    |
| VI1327A   | M6 ZN H=4 NUT                       |  |            |                               |  |      |             |     |     |          |                          |   |    |          |                                |   |    |          |              |   |    |          |                                     |   |    |
| OH7374A   | CORE PROBE CABLE PLATE              |  | OH7374A0   | CORE PROBE CABLE PLATE        |  |      |             |     |     |          |                          |   |    |          |                                |   |    |          |              |   |    |          |                                     |   |    |
| PE2037A   | MIND.MAPS ONE POWER CARD            |  | KPE2037A   | MIND.MAPS ONE POWER BOARD KIT | <table border="1"> <thead> <tr> <th>Code</th> <th>Description</th> <th>Qty</th> <th>UOM</th> </tr> </thead> <tbody> <tr> <td>PE2037A0</td> <td>MIND.MAPS ONE POWER CARD</td> <td>1</td> <td>PZ</td> </tr> <tr> <td>VI1850A0</td> <td>M4X6 NICKEL PLATED FIXING SCRE</td> <td>9</td> <td>PZ</td> </tr> <tr> <td>VM1745A0</td> <td>CARD SUPPORT</td> <td>9</td> <td>PZ</td> </tr> <tr> <td>VM2147A0</td> <td>ESD SPONGE PINK SMOOTH 410X343X15 M</td> <td>1</td> <td>PZ</td> </tr> </tbody> </table> | Code | Description | Qty | UOM | PE2037A0 | MIND.MAPS ONE POWER CARD | 1 | PZ | VI1850A0 | M4X6 NICKEL PLATED FIXING SCRE | 9 | PZ | VM1745A0 | CARD SUPPORT | 9 | PZ | VM2147A0 | ESD SPONGE PINK SMOOTH 410X343X15 M | 1 | PZ |
| Code      | Description                         | Qty   | UOM        |                               |  |      |             |     |     |          |                          |   |    |          |                                |   |    |          |              |   |    |          |                                     |   |    |
| PE2037A0  | MIND.MAPS ONE POWER CARD            | 1   | PZ         |                               |  |      |             |     |     |          |                          |   |    |          |                                |   |    |          |              |   |    |          |                                     |   |    |
| VI1850A0  | M4X6 NICKEL PLATED FIXING SCRE      | 9   | PZ         |                               |  |      |             |     |     |          |                          |   |    |          |                                |   |    |          |              |   |    |          |                                     |   |    |
| VM1745A0  | CARD SUPPORT                        | 9   | PZ         |                               |  |      |             |     |     |          |                          |   |    |          |                                |   |    |          |              |   |    |          |                                     |   |    |
| VM2147A0  | ESD SPONGE PINK SMOOTH 410X343X15 M | 1   | PZ         |                               |  |      |             |     |     |          |                          |   |    |          |                                |   |    |          |              |   |    |          |                                     |   |    |

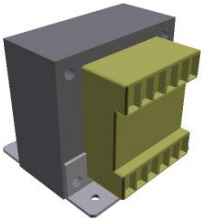

| COMPONENT |  |   | SPARE PART |                                   |   |      |             |     |     |          |                                   |   |    |          |  |   |    |
|-----------|--|---|------------|-----------------------------------|---|------|-------------|-----|-----|----------|-----------------------------------|---|----|----------|--|---|----|
| Code      | Description  | Image   | Code       | Description                       | Components list   |      |             |     |     |          |                                   |   |    |          |  |   |    |
| VE1639A   | TRANSFORMER<br>230-12VAC 60VA                      |  | KVE1639A   | 230-12VAC 60VA<br>TRANSFORMER KIT | <table border="1"> <thead> <tr> <th>Code</th> <th>Description</th> <th>Qty</th> <th>UOM</th> </tr> </thead> <tbody> <tr> <td>VE1639A0</td> <td>TRANSFORME<br/>R 230-12VAC<br/>60VA</td> <td>1</td> <td>PZ</td> </tr> <tr> <td>VI1950A0</td> <td>ST. STEEL<br/>4,2X13 TCB<br/>SELF-DRILLIN<br/>G SCREW</td> <td>4</td> <td>PZ</td> </tr> </tbody> </table> | Code | Description | Qty | UOM | VE1639A0 | TRANSFORME<br>R 230-12VAC<br>60VA | 1 | PZ | VI1950A0 | ST. STEEL<br>4,2X13 TCB<br>SELF-DRILLIN<br>G SCREW | 4 | PZ |
| Code      | Description  | Qty   | UOM        |                                   |   |      |             |     |     |          |                                   |   |    |          |  |   |    |
| VE1639A0  | TRANSFORME<br>R 230-12VAC<br>60VA                  | 1   | PZ         |                                   |   |      |             |     |     |          |                                   |   |    |          |  |   |    |
| VI1950A0  | ST. STEEL<br>4,2X13 TCB<br>SELF-DRILLIN<br>G SCREW | 4   | PZ         |                                   |   |      |             |     |     |          |                                   |   |    |          |  |   |    |



PLATON SERVICE  
8 (800) 500-34-47  
www.platonservice.com

ASM1817A/0.D04 - Door

FRONT

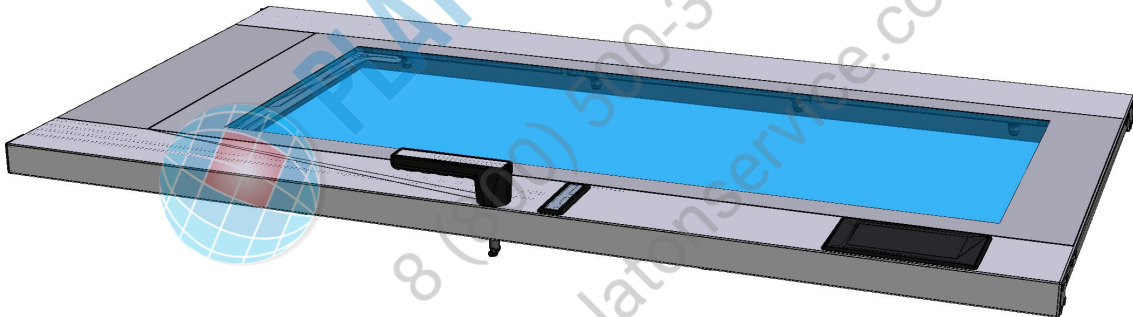

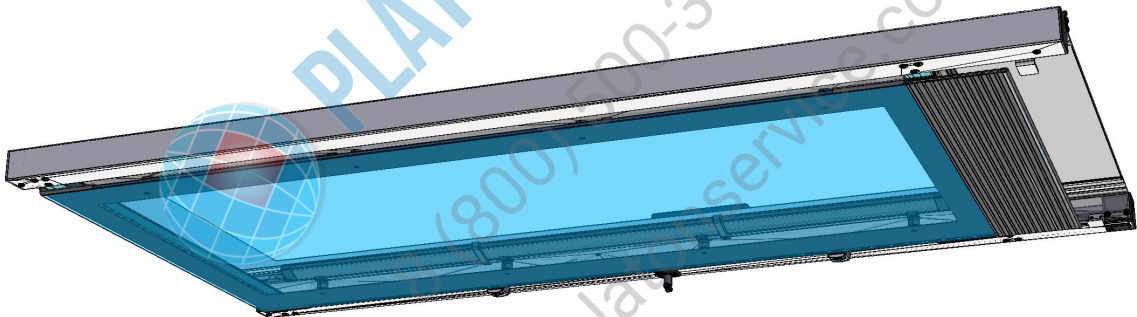

ASM1817A/0.D04 - Door

REAR





| COMPONENT |                                      |   | SPARE PART |                              |   |   |             |     |     |          |                                |   |    |          |                                      |   |    |          |                                      |   |    |          |                                |   |    |          |   |   |    |          |                              |   |    |          |                                       |   |    |          |                     |   |    |          |                         |   |    |          |                                |   |    |          |                               |   |    |          |                   |   |    |
|-----------|--------------------------------------|---|------------|------------------------------|---|---|-------------|-----|-----|----------|--------------------------------|---|----|----------|--------------------------------------|---|----|----------|--------------------------------------|---|----|----------|--------------------------------|---|----|----------|---|---|----|----------|------------------------------|---|----|----------|---------------------------------------|---|----|----------|---------------------|---|----|----------|-------------------------|---|----|----------|--------------------------------|---|----|----------|-------------------------------|---|----|----------|-------------------|---|----|
| Code      | Description                          | Image   | Code       | Description                  | Components list   |   |             |     |     |          |                                |   |    |          |                                      |   |    |          |                                      |   |    |          |                                |   |    |          |   |   |    |          |                              |   |    |          |                                       |   |    |          |                     |   |    |          |                         |   |    |          |                                |   |    |          |                               |   |    |          |                   |   |    |
| MG1083A   | MIND.MAPS DOOR COMPLETE HANDLE       |    | KMG1083A   | MIND.MAPS SERIES HANDLE KIT  | <table border="1"> <thead> <tr> <th>Code</th> <th>Description</th> <th>Qty</th> <th>UOM</th> </tr> </thead> <tbody> <tr> <td>0H7321A0</td> <td>MM STAINLESS STEEL HANDLE COVE</td> <td>1</td> <td>PZ</td> </tr> <tr> <td>RC1200A0</td> <td>ED=4 WIRE D.=0.5 COMPRESSIO N SPRING</td> <td>4</td> <td>PZ</td> </tr> <tr> <td>VI0239A1</td> <td>SELF-TAPPIN G SCREW 4.2X25 TCB+ INOX</td> <td>8</td> <td>PZ</td> </tr> <tr> <td>VI1220A1</td> <td>4,2X12 TCB SELF-TAPPIN G SCREW</td> <td>2</td> <td>PZ</td> </tr> <tr> <td>VM1182B1</td> <td>E. S. CT BT HANDLE JUNCTION + PIN GUIDE</td> <td>1</td> <td>PZ</td> </tr> <tr> <td>VM1183B0</td> <td>CHEFTOP/BAK ERTOP HANDLE PIN</td> <td>1</td> <td>PZ</td> </tr> <tr> <td>VM1490A0</td> <td>CHEFTOP/BAK ERTOP HANDLE SCREWS COVER</td> <td>2</td> <td>PZ</td> </tr> <tr> <td>VM1695A0</td> <td>HANDLE POSITION PIN</td> <td>4</td> <td>PZ</td> </tr> <tr> <td>VM2245A0</td> <td>HANDLE SHAFT WITH LATCH</td> <td>1</td> <td>PZ</td> </tr> <tr> <td>VM2247A0</td> <td>HANDLE SHAFT COVER VM2245-2246</td> <td>1</td> <td>PZ</td> </tr> <tr> <td>VM2248B0</td> <td>CLOSING HANDLE KEY WITH LATCH</td> <td>1</td> <td>PZ</td> </tr> <tr> <td>VM2295A0</td> <td>STYLUS PEN FOR MM</td> <td>1</td> <td>PZ</td> </tr> </tbody> </table> | Code                                    | Description | Qty | UOM | 0H7321A0 | MM STAINLESS STEEL HANDLE COVE | 1 | PZ | RC1200A0 | ED=4 WIRE D.=0.5 COMPRESSIO N SPRING | 4 | PZ | VI0239A1 | SELF-TAPPIN G SCREW 4.2X25 TCB+ INOX | 8 | PZ | VI1220A1 | 4,2X12 TCB SELF-TAPPIN G SCREW | 2 | PZ | VM1182B1 | E. S. CT BT HANDLE JUNCTION + PIN GUIDE | 1 | PZ | VM1183B0 | CHEFTOP/BAK ERTOP HANDLE PIN | 1 | PZ | VM1490A0 | CHEFTOP/BAK ERTOP HANDLE SCREWS COVER | 2 | PZ | VM1695A0 | HANDLE POSITION PIN | 4 | PZ | VM2245A0 | HANDLE SHAFT WITH LATCH | 1 | PZ | VM2247A0 | HANDLE SHAFT COVER VM2245-2246 | 1 | PZ | VM2248B0 | CLOSING HANDLE KEY WITH LATCH | 1 | PZ | VM2295A0 | STYLUS PEN FOR MM | 1 | PZ |
|           |                                      |   |            |                              | Code  | Description                             | Qty         | UOM |     |          |                                |   |    |          |                                      |   |    |          |                                      |   |    |          |                                |   |    |          |   |   |    |          |                              |   |    |          |                                       |   |    |          |                     |   |    |          |                         |   |    |          |                                |   |    |          |                               |   |    |          |                   |   |    |
|           |                                      |   |            |                              | 0H7321A0  | MM STAINLESS STEEL HANDLE COVE          | 1           | PZ  |     |          |                                |   |    |          |                                      |   |    |          |                                      |   |    |          |                                |   |    |          |   |   |    |          |                              |   |    |          |                                       |   |    |          |                     |   |    |          |                         |   |    |          |                                |   |    |          |                               |   |    |          |                   |   |    |
|           |                                      |   |            |                              | RC1200A0  | ED=4 WIRE D.=0.5 COMPRESSIO N SPRING    | 4           | PZ  |     |          |                                |   |    |          |                                      |   |    |          |                                      |   |    |          |                                |   |    |          |   |   |    |          |                              |   |    |          |                                       |   |    |          |                     |   |    |          |                         |   |    |          |                                |   |    |          |                               |   |    |          |                   |   |    |
|           |                                      |   |            |                              | VI0239A1  | SELF-TAPPIN G SCREW 4.2X25 TCB+ INOX    | 8           | PZ  |     |          |                                |   |    |          |                                      |   |    |          |                                      |   |    |          |                                |   |    |          |   |   |    |          |                              |   |    |          |                                       |   |    |          |                     |   |    |          |                         |   |    |          |                                |   |    |          |                               |   |    |          |                   |   |    |
|           |                                      |   |            |                              | VI1220A1  | 4,2X12 TCB SELF-TAPPIN G SCREW          | 2           | PZ  |     |          |                                |   |    |          |                                      |   |    |          |                                      |   |    |          |                                |   |    |          |   |   |    |          |                              |   |    |          |                                       |   |    |          |                     |   |    |          |                         |   |    |          |                                |   |    |          |                               |   |    |          |                   |   |    |
|           |                                      |   |            |                              | VM1182B1  | E. S. CT BT HANDLE JUNCTION + PIN GUIDE | 1           | PZ  |     |          |                                |   |    |          |                                      |   |    |          |                                      |   |    |          |                                |   |    |          |   |   |    |          |                              |   |    |          |                                       |   |    |          |                     |   |    |          |                         |   |    |          |                                |   |    |          |                               |   |    |          |                   |   |    |
|           |                                      |   |            |                              | VM1183B0  | CHEFTOP/BAK ERTOP HANDLE PIN            | 1           | PZ  |     |          |                                |   |    |          |                                      |   |    |          |                                      |   |    |          |                                |   |    |          |   |   |    |          |                              |   |    |          |                                       |   |    |          |                     |   |    |          |                         |   |    |          |                                |   |    |          |                               |   |    |          |                   |   |    |
|           |                                      |   |            |                              | VM1490A0  | CHEFTOP/BAK ERTOP HANDLE SCREWS COVER   | 2           | PZ  |     |          |                                |   |    |          |                                      |   |    |          |                                      |   |    |          |                                |   |    |          |   |   |    |          |                              |   |    |          |                                       |   |    |          |                     |   |    |          |                         |   |    |          |                                |   |    |          |                               |   |    |          |                   |   |    |
|           |                                      |   |            |                              | VM1695A0  | HANDLE POSITION PIN                     | 4           | PZ  |     |          |                                |   |    |          |                                      |   |    |          |                                      |   |    |          |                                |   |    |          |   |   |    |          |                              |   |    |          |                                       |   |    |          |                     |   |    |          |                         |   |    |          |                                |   |    |          |                               |   |    |          |                   |   |    |
|           |                                      |   |            |                              | VM2245A0  | HANDLE SHAFT WITH LATCH                 | 1           | PZ  |     |          |                                |   |    |          |                                      |   |    |          |                                      |   |    |          |                                |   |    |          |   |   |    |          |                              |   |    |          |                                       |   |    |          |                     |   |    |          |                         |   |    |          |                                |   |    |          |                               |   |    |          |                   |   |    |
|           |                                      |   |            |                              | VM2247A0  | HANDLE SHAFT COVER VM2245-2246          | 1           | PZ  |     |          |                                |   |    |          |                                      |   |    |          |                                      |   |    |          |                                |   |    |          |   |   |    |          |                              |   |    |          |                                       |   |    |          |                     |   |    |          |                         |   |    |          |                                |   |    |          |                               |   |    |          |                   |   |    |
|           |                                      |   |            |                              | VM2248B0  | CLOSING HANDLE KEY WITH LATCH           | 1           | PZ  |     |          |                                |   |    |          |                                      |   |    |          |                                      |   |    |          |                                |   |    |          |   |   |    |          |                              |   |    |          |                                       |   |    |          |                     |   |    |          |                         |   |    |          |                                |   |    |          |                               |   |    |          |                   |   |    |
| VM2295A0  | STYLUS PEN FOR MM                    | 1   | PZ         |                              |   |   |             |     |     |          |                                |   |    |          |                                      |   |    |          |                                      |   |    |          |                                |   |    |          |   |   |    |          |                              |   |    |          |                                       |   |    |          |                     |   |    |          |                         |   |    |          |                                |   |    |          |                               |   |    |          |                   |   |    |
| VM2315A   | MIND.MAPS INTERNAL GLASS CAP SUPPORT |  | KVM2315A   | MM INTERNAL GLASS SUPPORT KI | <table border="1"> <thead> <tr> <th>Code</th> <th>Description</th> <th>Qty</th> <th>UOM</th> </tr> </thead> <tbody> <tr> <td>VI1220A1</td> <td>4,2X12 TCB SELF-TAPPIN G SCREW</td> <td>3</td> <td>PZ</td> </tr> <tr> <td>VM1630A0</td> <td>INTERNAL GLASS PUSHING CAP</td> <td>3</td> <td>PZ</td> </tr> <tr> <td>VM2315A0</td> <td>MIND.MAPS INTERNAL GLASS CAP SUPPORT</td> <td>3</td> <td>PZ</td> </tr> </tbody> </table>   | Code                                    | Description | Qty | UOM | VI1220A1 | 4,2X12 TCB SELF-TAPPIN G SCREW | 3 | PZ | VM1630A0 | INTERNAL GLASS PUSHING CAP           | 3 | PZ | VM2315A0 | MIND.MAPS INTERNAL GLASS CAP SUPPORT | 3 | PZ |          |                                |   |    |          |   |   |    |          |                              |   |    |          |                                       |   |    |          |                     |   |    |          |                         |   |    |          |                                |   |    |          |                               |   |    |          |                   |   |    |
|           |                                      |   |            |                              | Code  | Description                             | Qty         | UOM |     |          |                                |   |    |          |                                      |   |    |          |                                      |   |    |          |                                |   |    |          |   |   |    |          |                              |   |    |          |                                       |   |    |          |                     |   |    |          |                         |   |    |          |                                |   |    |          |                               |   |    |          |                   |   |    |
|           |                                      |   |            |                              | VI1220A1  | 4,2X12 TCB SELF-TAPPIN G SCREW          | 3           | PZ  |     |          |                                |   |    |          |                                      |   |    |          |                                      |   |    |          |                                |   |    |          |   |   |    |          |                              |   |    |          |                                       |   |    |          |                     |   |    |          |                         |   |    |          |                                |   |    |          |                               |   |    |          |                   |   |    |
| VM1630A0  | INTERNAL GLASS PUSHING CAP           | 3   | PZ         |                              |   |   |             |     |     |          |                                |   |    |          |                                      |   |    |          |                                      |   |    |          |                                |   |    |          |   |   |    |          |                              |   |    |          |                                       |   |    |          |                     |   |    |          |                         |   |    |          |                                |   |    |          |                               |   |    |          |                   |   |    |
| VM2315A0  | MIND.MAPS INTERNAL GLASS CAP SUPPORT | 3   | PZ         |                              |   |   |             |     |     |          |                                |   |    |          |                                      |   |    |          |                                      |   |    |          |                                |   |    |          |   |   |    |          |                              |   |    |          |                                       |   |    |          |                     |   |    |          |                         |   |    |          |                                |   |    |          |                               |   |    |          |                   |   |    |

| COMPONENT |                                   |   | SPARE PART                      |   |   |      |             |     |     |          |                               |    |    |          |                                   |   |    |          |                                   |     |     |          |                                  |   |    |
|-----------|-----------------------------------|---|---------------------------------|---|---|------|-------------|-----|-----|----------|-------------------------------|----|----|----------|-----------------------------------|---|----|----------|-----------------------------------|-----|-----|----------|----------------------------------|---|----|
| Code      | Description                       | Image   | Code                            | Description   | Components list   |      |             |     |     |          |                               |    |    |          |                                   |   |    |          |                                   |     |     |          |                                  |   |    |
| VM1630A   | INTERNAL GLASS PUSHING CAP        |    | KVM1630A                        | CAP FOR INTERNAL GLASS 10 PCS KIT   | <table border="1"> <thead> <tr> <th>Code</th> <th>Description</th> <th>Qty</th> <th>UOM</th> </tr> </thead> <tbody> <tr> <td>VM1630A0</td> <td>INTERNAL GLASS PUSHING CAP</td> <td>10</td> <td>PZ</td> </tr> </tbody> </table>  | Code | Description | Qty | UOM | VM1630A0 | INTERNAL GLASS PUSHING CAP    | 10 | PZ |          |                                   |   |    |          |                                   |     |     |          |                                  |   |    |
| Code      | Description                       | Qty   | UOM                             |   |   |      |             |     |     |          |                               |    |    |          |                                   |   |    |          |                                   |     |     |          |                                  |   |    |
| VM1630A0  | INTERNAL GLASS PUSHING CAP        | 10  | PZ                              |   |   |      |             |     |     |          |                               |    |    |          |                                   |   |    |          |                                   |     |     |          |                                  |   |    |
| VM2371A   | DOUBLE GLASS DOOR PUSHING BRACKET |    | KVM2371A                        | INTERNAL DOUBLE GLASS SUPPORT 3 PCS KIT                                   | <table border="1"> <thead> <tr> <th>Code</th> <th>Description</th> <th>Qty</th> <th>UOM</th> </tr> </thead> <tbody> <tr> <td>V11220A1</td> <td>4,2X12 TCB SELF-TAPPING SCREW</td> <td>3</td> <td>PZ</td> </tr> <tr> <td>VM2371A0</td> <td>DOUBLE GLASS DOOR PUSHING BRACKET</td> <td>3</td> <td>PZ</td> </tr> <tr> <td>VM2371A0</td> <td>DOUBLE GLASS DOOR PUSHING BRACKET</td> <td>3</td> <td>PZ</td> </tr> </tbody> </table>  | Code | Description | Qty | UOM | V11220A1 | 4,2X12 TCB SELF-TAPPING SCREW | 3  | PZ | VM2371A0 | DOUBLE GLASS DOOR PUSHING BRACKET | 3 | PZ | VM2371A0 | DOUBLE GLASS DOOR PUSHING BRACKET | 3   | PZ  |          |                                  |   |    |
| Code      | Description                       | Qty   | UOM                             |   |   |      |             |     |     |          |                               |    |    |          |                                   |   |    |          |                                   |     |     |          |                                  |   |    |
| V11220A1  | 4,2X12 TCB SELF-TAPPING SCREW     | 3   | PZ                              |   |   |      |             |     |     |          |                               |    |    |          |                                   |   |    |          |                                   |     |     |          |                                  |   |    |
| VM2371A0  | DOUBLE GLASS DOOR PUSHING BRACKET | 3   | PZ                              |   |   |      |             |     |     |          |                               |    |    |          |                                   |   |    |          |                                   |     |     |          |                                  |   |    |
| VM2371A0  | DOUBLE GLASS DOOR PUSHING BRACKET | 3   | PZ                              |   |   |      |             |     |     |          |                               |    |    |          |                                   |   |    |          |                                   |     |     |          |                                  |   |    |
| VN1177A   | CONTROL BOARD COOLING FAN         |  | KVN1177A                        | CONTROL BOARD COOLING FAN KIT   | <table border="1"> <thead> <tr> <th>Code</th> <th>Description</th> <th>Qty</th> <th>UOM</th> </tr> </thead> <tbody> <tr> <td>VN1177A0</td> <td>CONTROL BOARD COOLING FAN</td> <td>1</td> <td>PZ</td> </tr> <tr> <td>VN1177A0</td> <td>CONTROL BOARD COOLING FAN</td> <td>1</td> <td>PZ</td> </tr> </tbody> </table>   | Code | Description | Qty | UOM | VN1177A0 | CONTROL BOARD COOLING FAN     | 1  | PZ | VN1177A0 | CONTROL BOARD COOLING FAN         | 1 | PZ |          |                                   |     |     |          |                                  |   |    |
| Code      | Description                       | Qty   | UOM                             |   |   |      |             |     |     |          |                               |    |    |          |                                   |   |    |          |                                   |     |     |          |                                  |   |    |
| VN1177A0  | CONTROL BOARD COOLING FAN         | 1   | PZ                              |   |   |      |             |     |     |          |                               |    |    |          |                                   |   |    |          |                                   |     |     |          |                                  |   |    |
| VN1177A0  | CONTROL BOARD COOLING FAN         | 1   | PZ                              |   |   |      |             |     |     |          |                               |    |    |          |                                   |   |    |          |                                   |     |     |          |                                  |   |    |
| VM2316A   | CONTROL BOARD COOLING FAN HOLDER  |  | <p>KVM2518A</p> <p>KVM2316A</p> | <p>PANEL COOLING FAN SUPPORT KIT</p> <p>PANEL COOLING FAN SUPPORT KIT</p> | <table border="1"> <thead> <tr> <th>Code</th> <th>Description</th> <th>Qty</th> <th>UOM</th> </tr> </thead> <tbody> <tr> <td>VM2518A0</td> <td>BOARD COOLING FAN SUPPORT</td> <td>1</td> <td>PZ</td> </tr> <tr> <td>VM2518A0</td> <td>BOARD COOLING FAN SUPPORT</td> <td>1</td> <td>PZ</td> </tr> </tbody> </table> <table border="1"> <thead> <tr> <th>Code</th> <th>Description</th> <th>Qty</th> <th>UOM</th> </tr> </thead> <tbody> <tr> <td>VM2316A0</td> <td>CONTROL BOARD COOLING FAN HOLDER</td> <td>1</td> <td>PZ</td> </tr> </tbody> </table> | Code | Description | Qty | UOM | VM2518A0 | BOARD COOLING FAN SUPPORT     | 1  | PZ | VM2518A0 | BOARD COOLING FAN SUPPORT         | 1 | PZ | Code     | Description                       | Qty | UOM | VM2316A0 | CONTROL BOARD COOLING FAN HOLDER | 1 | PZ |
| Code      | Description                       | Qty   | UOM                             |   |   |      |             |     |     |          |                               |    |    |          |                                   |   |    |          |                                   |     |     |          |                                  |   |    |
| VM2518A0  | BOARD COOLING FAN SUPPORT         | 1   | PZ                              |   |   |      |             |     |     |          |                               |    |    |          |                                   |   |    |          |                                   |     |     |          |                                  |   |    |
| VM2518A0  | BOARD COOLING FAN SUPPORT         | 1   | PZ                              |   |   |      |             |     |     |          |                               |    |    |          |                                   |   |    |          |                                   |     |     |          |                                  |   |    |
| Code      | Description                       | Qty   | UOM                             |   |   |      |             |     |     |          |                               |    |    |          |                                   |   |    |          |                                   |     |     |          |                                  |   |    |
| VM2316A0  | CONTROL BOARD COOLING FAN HOLDER  | 1   | PZ                              |   |   |      |             |     |     |          |                               |    |    |          |                                   |   |    |          |                                   |     |     |          |                                  |   |    |

| COMPONENT |  |  | SPARE PART |  |  |      |             |                                |     |          |  |  |    |    |
|-----------|--|--|------------|--|--|------|-------------|--------------------------------|-----|----------|--|--|----|----|
| Code      | Description                                    | Image  | Code       | Description                                | Components list  |      |             |                                |     |          |  |  |    |    |
| VE1030A   | MAGNET FOR DOOR<br>MICROSWITCH<br>D=22,9MM     |   | KVE1030A   | 2 PCS MAGNET KIT<br>FOR DOOR SWITCH        | <table border="1"> <thead> <tr> <th>Code</th> <th>Description</th> <th>Qty</th> <th>UOM</th> </tr> </thead> <tbody> <tr> <td>VE1030A1</td> <td>MAGNET FOR<br/>DOOR<br/>MICROSWITC<br/>H D=22,9MM</td> <td>2</td> <td>PZ</td> </tr> </tbody> </table> | Code | Description | Qty                            | UOM | VE1030A1 | MAGNET FOR<br>DOOR<br>MICROSWITC<br>H D=22,9MM | 2  | PZ |    |
|           |  |  | Code       | Description                                | Qty  | UOM  |             |                                |     |          |  |  |    |    |
| VE1030A1  | MAGNET FOR<br>DOOR<br>MICROSWITC<br>H D=22,9MM | 2  | PZ         |  |  |      |             |                                |     |          |  |  |    |    |
| KVE1020A  | MICROSWITCH KIT                                | <table border="1"> <thead> <tr> <th>Code</th> <th>Description</th> <th>Qty</th> <th>UOM</th> </tr> </thead> <tbody> <tr> <td>VE1020A2</td> <td>MAGNETIC<br/>DOOR<br/>MICROSWITC</td> <td>1</td> <td>PZ</td> </tr> <tr> <td>VE1030A1</td> <td>MAGNET FOR<br/>DOOR<br/>MICROSWITC<br/>H D=22,9MM</td> <td>4</td> <td>PZ</td> </tr> </tbody> </table> | Code       | Description                                | Qty  | UOM  | VE1020A2    | MAGNETIC<br>DOOR<br>MICROSWITC | 1   | PZ       | VE1030A1                                       | MAGNET FOR<br>DOOR<br>MICROSWITC<br>H D=22,9MM | 4  | PZ |
| Code      | Description                                    | Qty  | UOM        |  |  |      |             |                                |     |          |  |  |    |    |
| VE1020A2  | MAGNETIC<br>DOOR<br>MICROSWITC                 | 1  | PZ         |  |  |      |             |                                |     |          |  |  |    |    |
| VE1030A1  | MAGNET FOR<br>DOOR<br>MICROSWITC<br>H D=22,9MM | 4  | PZ         |  |  |      |             |                                |     |          |  |  |    |    |
| 0H7242A   | XEVC-2011 DOOR<br>GLASS SUPPORT<br>PLATE       |    | 0H7242A0   | XEVC-2011 DOOR<br>GLASS SUPPORT<br>PLATE   |  |      |             |                                |     |          |  |  |    |    |
| 0H7243A   | XEVC-2011 LOWER<br>DOOR PROFILE                |   | 0H7243A0   | XEVC-2011 LOWER<br>DOOR PROFILE            |  |      |             |                                |     |          |  |  |    |    |
| 0H7244A   | XEVC-2011<br>INT.DOOR GLASS<br>LOWER FRAME     |   | 0H7244A0   | XEVC-2011<br>INT.DOOR GLASS<br>LOWER FRAME |  |      |             |                                |     |          |  |  |    |    |
| 0H7245A   | XEVC-2011<br>INT.DOOR GLASS<br>UPPER FRAME     |   | 0H7245A0   | XEVC-2011<br>INT.DOOR GLASS<br>UPPER FRAME |  |      |             |                                |     |          |  |  |    |    |

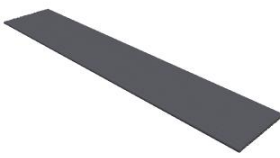
| COMPONENT |  |  | SPARE PART |   |  |      |             |  |     |          |                                    |             |    |          |                          |                          |       |          |  |  |     |          |                                   |                           |    |          |                            |                            |    |          |  |  |    |          |                               |                               |    |    |
|-----------|--|--|------------|---|--|------|-------------|--|-----|----------|------------------------------------|-------------|----|----------|--------------------------|--------------------------|-------|----------|--|--|-----|----------|-----------------------------------|---------------------------|----|----------|----------------------------|----------------------------|----|----------|--|--|----|----------|-------------------------------|-------------------------------|----|----|
| Code      | Description                                  | Image  | Code       | Description                             | Components list  |      |             |  |     |          |                                    |             |    |          |                          |                          |       |          |  |  |     |          |                                   |                           |    |          |                            |                            |    |          |  |  |    |          |                               |                               |    |    |
| 0H7246A   | XEVC-2011 GASKET<br>HOLDER PLATE             |   | KG1553A    | MIND.MAPS<br>DOOR-TROLLEY<br>GASKET KIT | <table border="1"> <thead> <tr> <th>Code</th> <th>Description</th> <th>Qty</th> <th>UOM</th> </tr> </thead> <tbody> <tr> <td>0H7246A0</td> <td>XEVC-2011<br/>GASKET<br/>HOLDER PLAT</td> <td>1</td> <td>PZ</td> </tr> <tr> <td>GN1341B0</td> <td>DOOR-TROLL<br/>EY SEALING</td> <td>0.750</td> <td>M</td> </tr> <tr> <td>SL1170A1</td> <td>S53 BLACK<br/>SILICON -<br/>310ML<br/>CARTRIDGE</td> <td>280</td> <td>ML</td> </tr> <tr> <td>TB2912A0</td> <td>DOOR<br/>GASKET PIN<br/>XEVC-2011-E</td> <td>2</td> <td>PZ</td> </tr> <tr> <td>VI1075A0</td> <td>NUT M4 H=4<br/>UNI5587 INOX</td> <td>3</td> <td>PZ</td> </tr> <tr> <td>VI1511A0</td> <td>STAINLESS<br/>STEEL<br/>WASHER<br/>4.2X12X1</td> <td>3</td> <td>PZ</td> </tr> <tr> <td>VI1925A0</td> <td>ST STEEL<br/>STUD BOLT<br/>M4X8</td> <td>3</td> <td>PZ</td> </tr> </tbody> </table> | Code | Description | Qty                                      | UOM | 0H7246A0 | XEVC-2011<br>GASKET<br>HOLDER PLAT | 1           | PZ | GN1341B0 | DOOR-TROLL<br>EY SEALING | 0.750                    | M     | SL1170A1 | S53 BLACK<br>SILICON -<br>310ML<br>CARTRIDGE | 280  | ML  | TB2912A0 | DOOR<br>GASKET PIN<br>XEVC-2011-E | 2                         | PZ | VI1075A0 | NUT M4 H=4<br>UNI5587 INOX | 3                          | PZ | VI1511A0 | STAINLESS<br>STEEL<br>WASHER<br>4.2X12X1 | 3  | PZ | VI1925A0 | ST STEEL<br>STUD BOLT<br>M4X8 | 3                             | PZ |    |
|           |  |  | Code       | Description                             | Qty  | UOM  |             |  |     |          |                                    |             |    |          |                          |                          |       |          |  |  |     |          |                                   |                           |    |          |                            |                            |    |          |  |  |    |          |                               |                               |    |    |
| 0H7246A0  | XEVC-2011<br>GASKET<br>HOLDER PLAT           | 1  | PZ         |   |  |      |             |  |     |          |                                    |             |    |          |                          |                          |       |          |  |  |     |          |                                   |                           |    |          |                            |                            |    |          |  |  |    |          |                               |                               |    |    |
| GN1341B0  | DOOR-TROLL<br>EY SEALING                     | 0.750  | M          |   |  |      |             |  |     |          |                                    |             |    |          |                          |                          |       |          |  |  |     |          |                                   |                           |    |          |                            |                            |    |          |  |  |    |          |                               |                               |    |    |
| SL1170A1  | S53 BLACK<br>SILICON -<br>310ML<br>CARTRIDGE | 280  | ML         |   |  |      |             |  |     |          |                                    |             |    |          |                          |                          |       |          |  |  |     |          |                                   |                           |    |          |                            |                            |    |          |  |  |    |          |                               |                               |    |    |
| TB2912A0  | DOOR<br>GASKET PIN<br>XEVC-2011-E            | 2  | PZ         |   |  |      |             |  |     |          |                                    |             |    |          |                          |                          |       |          |  |  |     |          |                                   |                           |    |          |                            |                            |    |          |  |  |    |          |                               |                               |    |    |
| VI1075A0  | NUT M4 H=4<br>UNI5587 INOX                   | 3  | PZ         |   |  |      |             |  |     |          |                                    |             |    |          |                          |                          |       |          |  |  |     |          |                                   |                           |    |          |                            |                            |    |          |  |  |    |          |                               |                               |    |    |
| VI1511A0  | STAINLESS<br>STEEL<br>WASHER<br>4.2X12X1     | 3  | PZ         |   |  |      |             |  |     |          |                                    |             |    |          |                          |                          |       |          |  |  |     |          |                                   |                           |    |          |                            |                            |    |          |  |  |    |          |                               |                               |    |    |
| VI1925A0  | ST STEEL<br>STUD BOLT<br>M4X8                | 3  | PZ         |   |  |      |             |  |     |          |                                    |             |    |          |                          |                          |       |          |  |  |     |          |                                   |                           |    |          |                            |                            |    |          |  |  |    |          |                               |                               |    |    |
| KG1341B   | 1005E-4005E<br>TROLLEY DOOR<br>GASKET KIT    | <table border="1"> <thead> <tr> <th>Code</th> <th>Description</th> <th>Qty</th> <th>UOM</th> </tr> </thead> <tbody> <tr> <td>0H3178A0</td> <td>SERIE1000-40<br/>00 GASKET<br/>HOLDER PLAT</td> <td>1</td> <td>PZ</td> </tr> <tr> <td>0H4936A0</td> <td>DRILL GUIDE</td> <td>1</td> <td>PZ</td> </tr> <tr> <td>GN1341B0</td> <td>DOOR-TROLL<br/>EY SEALING</td> <td>0.730</td> <td>M</td> </tr> <tr> <td>SL1170A1</td> <td>S53 BLACK<br/>SILICON -<br/>310ML<br/>CARTRIDGE</td> <td>280</td> <td>ML</td> </tr> <tr> <td>TB2305A0</td> <td>5E BIG SERIES<br/>DOOR PIN</td> <td>2</td> <td>PZ</td> </tr> <tr> <td>VI1075A0</td> <td>NUT M4 H=4<br/>UNI5587 INOX</td> <td>3</td> <td>PZ</td> </tr> <tr> <td>VI1511A0</td> <td>STAINLESS<br/>STEEL<br/>WASHER<br/>4.2X12X1</td> <td>3</td> <td>PZ</td> </tr> <tr> <td>VI1925A0</td> <td>ST STEEL<br/>STUD BOLT<br/>M4X8</td> <td>3</td> <td>PZ</td> </tr> </tbody> </table> | Code       | Description                             | Qty  | UOM  | 0H3178A0    | SERIE1000-40<br>00 GASKET<br>HOLDER PLAT | 1   | PZ       | 0H4936A0                           | DRILL GUIDE | 1  | PZ       | GN1341B0                 | DOOR-TROLL<br>EY SEALING | 0.730 | M        | SL1170A1                                     | S53 BLACK<br>SILICON -<br>310ML<br>CARTRIDGE | 280 | ML       | TB2305A0                          | 5E BIG SERIES<br>DOOR PIN | 2  | PZ       | VI1075A0                   | NUT M4 H=4<br>UNI5587 INOX | 3  | PZ       | VI1511A0                                 | STAINLESS<br>STEEL<br>WASHER<br>4.2X12X1 | 3  | PZ       | VI1925A0                      | ST STEEL<br>STUD BOLT<br>M4X8 | 3  | PZ |
| Code      | Description                                  | Qty  | UOM        |   |  |      |             |  |     |          |                                    |             |    |          |                          |                          |       |          |  |  |     |          |                                   |                           |    |          |                            |                            |    |          |  |  |    |          |                               |                               |    |    |
| 0H3178A0  | SERIE1000-40<br>00 GASKET<br>HOLDER PLAT     | 1  | PZ         |   |  |      |             |  |     |          |                                    |             |    |          |                          |                          |       |          |  |  |     |          |                                   |                           |    |          |                            |                            |    |          |  |  |    |          |                               |                               |    |    |
| 0H4936A0  | DRILL GUIDE                                  | 1  | PZ         |   |  |      |             |  |     |          |                                    |             |    |          |                          |                          |       |          |  |  |     |          |                                   |                           |    |          |                            |                            |    |          |  |  |    |          |                               |                               |    |    |
| GN1341B0  | DOOR-TROLL<br>EY SEALING                     | 0.730  | M          |   |  |      |             |  |     |          |                                    |             |    |          |                          |                          |       |          |  |  |     |          |                                   |                           |    |          |                            |                            |    |          |  |  |    |          |                               |                               |    |    |
| SL1170A1  | S53 BLACK<br>SILICON -<br>310ML<br>CARTRIDGE | 280  | ML         |   |  |      |             |  |     |          |                                    |             |    |          |                          |                          |       |          |  |  |     |          |                                   |                           |    |          |                            |                            |    |          |  |  |    |          |                               |                               |    |    |
| TB2305A0  | 5E BIG SERIES<br>DOOR PIN                    | 2  | PZ         |   |  |      |             |  |     |          |                                    |             |    |          |                          |                          |       |          |  |  |     |          |                                   |                           |    |          |                            |                            |    |          |  |  |    |          |                               |                               |    |    |
| VI1075A0  | NUT M4 H=4<br>UNI5587 INOX                   | 3  | PZ         |   |  |      |             |  |     |          |                                    |             |    |          |                          |                          |       |          |  |  |     |          |                                   |                           |    |          |                            |                            |    |          |  |  |    |          |                               |                               |    |    |
| VI1511A0  | STAINLESS<br>STEEL<br>WASHER<br>4.2X12X1     | 3  | PZ         |   |  |      |             |  |     |          |                                    |             |    |          |                          |                          |       |          |  |  |     |          |                                   |                           |    |          |                            |                            |    |          |  |  |    |          |                               |                               |    |    |
| VI1925A0  | ST STEEL<br>STUD BOLT<br>M4X8                | 3  | PZ         |   |  |      |             |  |     |          |                                    |             |    |          |                          |                          |       |          |  |  |     |          |                                   |                           |    |          |                            |                            |    |          |  |  |    |          |                               |                               |    |    |
| GN1553A   | XEVC-2011-E<br>DOOR-TROLLEY<br>SEALING       |   | KG1553A    | MIND.MAPS<br>DOOR-TROLLEY<br>GASKET KIT | <table border="1"> <thead> <tr> <th>Code</th> <th>Description</th> <th>Qty</th> <th>UOM</th> </tr> </thead> <tbody> <tr> <td>0H7246A0</td> <td>XEVC-2011<br/>GASKET<br/>HOLDER PLAT</td> <td>1</td> <td>PZ</td> </tr> <tr> <td>GN1341B0</td> <td>DOOR-TROLL<br/>EY SEALING</td> <td>0.750</td> <td>M</td> </tr> <tr> <td>SL1170A1</td> <td>S53 BLACK<br/>SILICON -<br/>310ML<br/>CARTRIDGE</td> <td>280</td> <td>ML</td> </tr> </tbody> </table>   | Code | Description | Qty                                      | UOM | 0H7246A0 | XEVC-2011<br>GASKET<br>HOLDER PLAT | 1           | PZ | GN1341B0 | DOOR-TROLL<br>EY SEALING | 0.750                    | M     | SL1170A1 | S53 BLACK<br>SILICON -<br>310ML<br>CARTRIDGE | 280  | ML  |          |                                   |                           |    |          |                            |                            |    |          |  |  |    |          |                               |                               |    |    |
| Code      | Description                                  | Qty  | UOM        |   |  |      |             |  |     |          |                                    |             |    |          |                          |                          |       |          |  |  |     |          |                                   |                           |    |          |                            |                            |    |          |  |  |    |          |                               |                               |    |    |
| 0H7246A0  | XEVC-2011<br>GASKET<br>HOLDER PLAT           | 1  | PZ         |   |  |      |             |  |     |          |                                    |             |    |          |                          |                          |       |          |  |  |     |          |                                   |                           |    |          |                            |                            |    |          |  |  |    |          |                               |                               |    |    |
| GN1341B0  | DOOR-TROLL<br>EY SEALING                     | 0.750  | M          |   |  |      |             |  |     |          |                                    |             |    |          |                          |                          |       |          |  |  |     |          |                                   |                           |    |          |                            |                            |    |          |  |  |    |          |                               |                               |    |    |
| SL1170A1  | S53 BLACK<br>SILICON -<br>310ML<br>CARTRIDGE | 280  | ML         |   |  |      |             |  |     |          |                                    |             |    |          |                          |                          |       |          |  |  |     |          |                                   |                           |    |          |                            |                            |    |          |  |  |    |          |                               |                               |    |    |

| COMPONENT |  |   | SPARE PART |   |   |      |             |     |     |          |                                     |    |    |          |                            |   |    |          |  |   |    |          |                               |   |    |
|-----------|--|---|------------|---|---|------|-------------|-----|-----|----------|-------------------------------------|----|----|----------|----------------------------|---|----|----------|--|---|----|----------|-------------------------------|---|----|
| Code      | Description                              | Image   | Code       | Description                                 | Components list   |      |             |     |     |          |                                     |    |    |          |                            |   |    |          |  |   |    |          |                               |   |    |
| GN1553A   | XEVC-2011-E<br>DOOR-TROLLEY<br>SEALING   |    | KGN1553A   | MIND.MAPS<br>DOOR-TROLLEY<br>GASKET KIT     | <table border="1"> <thead> <tr> <th>Code</th> <th>Description</th> <th>Qty</th> <th>UOM</th> </tr> </thead> <tbody> <tr> <td>TB2912A0</td> <td>DOOR<br/>GASKET PIN<br/>XEVC-2011-E</td> <td>2</td> <td>PZ</td> </tr> <tr> <td>VI1075A0</td> <td>NUT M4 H=4<br/>UNI5587 INOX</td> <td>3</td> <td>PZ</td> </tr> <tr> <td>VI1511A0</td> <td>STAINLESS<br/>STEEL<br/>WASHER<br/>4.2X12X1</td> <td>3</td> <td>PZ</td> </tr> <tr> <td>VI1925A0</td> <td>ST STEEL<br/>STUD BOLT<br/>M4X8</td> <td>3</td> <td>PZ</td> </tr> </tbody> </table> | Code | Description | Qty | UOM | TB2912A0 | DOOR<br>GASKET PIN<br>XEVC-2011-E   | 2  | PZ | VI1075A0 | NUT M4 H=4<br>UNI5587 INOX | 3 | PZ | VI1511A0 | STAINLESS<br>STEEL<br>WASHER<br>4.2X12X1 | 3 | PZ | VI1925A0 | ST STEEL<br>STUD BOLT<br>M4X8 | 3 | PZ |
| Code      | Description                              | Qty   | UOM        |   |   |      |             |     |     |          |                                     |    |    |          |                            |   |    |          |  |   |    |          |                               |   |    |
| TB2912A0  | DOOR<br>GASKET PIN<br>XEVC-2011-E        | 2   | PZ         |   |   |      |             |     |     |          |                                     |    |    |          |                            |   |    |          |  |   |    |          |                               |   |    |
| VI1075A0  | NUT M4 H=4<br>UNI5587 INOX               | 3   | PZ         |   |   |      |             |     |     |          |                                     |    |    |          |                            |   |    |          |  |   |    |          |                               |   |    |
| VI1511A0  | STAINLESS<br>STEEL<br>WASHER<br>4.2X12X1 | 3   | PZ         |   |   |      |             |     |     |          |                                     |    |    |          |                            |   |    |          |  |   |    |          |                               |   |    |
| VI1925A0  | ST STEEL<br>STUD BOLT<br>M4X8            | 3   | PZ         |   |   |      |             |     |     |          |                                     |    |    |          |                            |   |    |          |  |   |    |          |                               |   |    |
| TB2912A   | DOOR GASKET PIN<br>XEVC-2011-E           |   | TB2912A0   | DOOR GASKET PIN<br>XEVC-2011-E              |   |      |             |     |     |          |                                     |    |    |          |                            |   |    |          |  |   |    |          |                               |   |    |
| VI1995A   | M5X25 ST.STEEL<br>SCREW                  |  | VI1995A0   | M5X25 ST.STEEL<br>SCREW                     |   |      |             |     |     |          |                                     |    |    |          |                            |   |    |          |  |   |    |          |                               |   |    |
| VM2305A   | 6 SERIES DOOR<br>CAP FIXING PAWL         |  | KVM2305A   | MM FIXING DOOR<br>THUB SCREWS 10<br>PCS KIT | <table border="1"> <thead> <tr> <th>Code</th> <th>Description</th> <th>Qty</th> <th>UOM</th> </tr> </thead> <tbody> <tr> <td>VM2305A0</td> <td>6 SERIES<br/>DOOR CAP<br/>FIXING PAWL</td> <td>10</td> <td>PZ</td> </tr> </tbody> </table>   | Code | Description | Qty | UOM | VM2305A0 | 6 SERIES<br>DOOR CAP<br>FIXING PAWL | 10 | PZ |          |                            |   |    |          |  |   |    |          |                               |   |    |
| Code      | Description                              | Qty   | UOM        |   |   |      |             |     |     |          |                                     |    |    |          |                            |   |    |          |  |   |    |          |                               |   |    |
| VM2305A0  | 6 SERIES<br>DOOR CAP<br>FIXING PAWL      | 10  | PZ         |   |   |      |             |     |     |          |                                     |    |    |          |                            |   |    |          |  |   |    |          |                               |   |    |
| VM2275A   | SMOOTH BUSHING                           |  | KVM2275A   | SMOOTH PIN<br>BUSHING KIT                   | <table border="1"> <thead> <tr> <th>Code</th> <th>Description</th> <th>Qty</th> <th>UOM</th> </tr> </thead> <tbody> <tr> <td>VM2275A0</td> <td>SMOOTH<br/>BUSHING</td> <td>1</td> <td>PZ</td> </tr> </tbody> </table>   | Code | Description | Qty | UOM | VM2275A0 | SMOOTH<br>BUSHING                   | 1  | PZ |          |                            |   |    |          |  |   |    |          |                               |   |    |
| Code      | Description                              | Qty   | UOM        |   |   |      |             |     |     |          |                                     |    |    |          |                            |   |    |          |  |   |    |          |                               |   |    |
| VM2275A0  | SMOOTH<br>BUSHING                        | 1   | PZ         |   |   |      |             |     |     |          |                                     |    |    |          |                            |   |    |          |  |   |    |          |                               |   |    |

| COMPONENT |                                     |   | SPARE PART |   |  |      |             |     |     |          |                               |   |    |          |                                     |   |    |          |                               |   |    |
|-----------|-------------------------------------|---|------------|---|--|------|-------------|-----|-----|----------|-------------------------------|---|----|----------|-------------------------------------|---|----|----------|-------------------------------|---|----|
| Code      | Description                         | Image   | Code       | Description                             | Components list  |      |             |     |     |          |                               |   |    |          |                                     |   |    |          |                               |   |    |
| VM2264A   | MM BIG DOOR UPPER CAP               |    | KVM2264A   | MM TROLLEY OVEN DOOR LEFT UPPER CAP KIT | <table border="1"> <thead> <tr> <th>Code</th> <th>Description</th> <th>Qty</th> <th>UOM</th> </tr> </thead> <tbody> <tr> <td>VM2264A0</td> <td>MM BIG DOOR UPPER CAP</td> <td>1</td> <td>PZ</td> </tr> </tbody> </table>   | Code | Description | Qty | UOM | VM2264A0 | MM BIG DOOR UPPER CAP         | 1 | PZ |          |                                     |   |    |          |                               |   |    |
| Code      | Description                         | Qty   | UOM        |   |  |      |             |     |     |          |                               |   |    |          |                                     |   |    |          |                               |   |    |
| VM2264A0  | MM BIG DOOR UPPER CAP               | 1   | PZ         |   |  |      |             |     |     |          |                               |   |    |          |                                     |   |    |          |                               |   |    |
| VM2266A   | MM BIG DOOR UPPER RIGHT CAP         |    | VM2266A0   | MM BIG DOOR UPPER RIGHT CAP             |  |      |             |     |     |          |                               |   |    |          |                                     |   |    |          |                               |   |    |
| 0H7247A   | XEVC-2011 UPPER DOOR PROFILE        |  | 0H7247A0   | XEVC-2011 UPPER DOOR PROFILE            |  |      |             |     |     |          |                               |   |    |          |                                     |   |    |          |                               |   |    |
| 0H7248A   | XEVC-2011 DOOR CAM                  |  |            |   |  |      |             |     |     |          |                               |   |    |          |                                     |   |    |          |                               |   |    |
| VM2274A   | GROOVED BUSHING                     |  | KVM2274A   | GROOVED PIN BUSHING KIT                 | <table border="1"> <thead> <tr> <th>Code</th> <th>Description</th> <th>Qty</th> <th>UOM</th> </tr> </thead> <tbody> <tr> <td>VM2274A0</td> <td>GROOVED BUSHING</td> <td>1</td> <td>PZ</td> </tr> </tbody> </table>   | Code | Description | Qty | UOM | VM2274A0 | GROOVED BUSHING               | 1 | PZ |          |                                     |   |    |          |                               |   |    |
| Code      | Description                         | Qty   | UOM        |   |  |      |             |     |     |          |                               |   |    |          |                                     |   |    |          |                               |   |    |
| VM2274A0  | GROOVED BUSHING                     | 1   | PZ         |   |  |      |             |     |     |          |                               |   |    |          |                                     |   |    |          |                               |   |    |
|           |                                     |   | K0B1126AR  | BAKERTOP MM RIGHT DOOR LOWER BEAM KIT   | <table border="1"> <thead> <tr> <th>Code</th> <th>Description</th> <th>Qty</th> <th>UOM</th> </tr> </thead> <tbody> <tr> <td>0B1126A0</td> <td>DOOR LOWER FRAME SHAPE 860 MM</td> <td>1</td> <td>PZ</td> </tr> <tr> <td>RC1200A0</td> <td>ED=4 WIRE D.=0.5 COMPRESSION SPRING</td> <td>2</td> <td>PZ</td> </tr> <tr> <td>V11220A1</td> <td>4,2X12 TCB SELF-TAPPING SCREW</td> <td>1</td> <td>PZ</td> </tr> </tbody> </table> | Code | Description | Qty | UOM | 0B1126A0 | DOOR LOWER FRAME SHAPE 860 MM | 1 | PZ | RC1200A0 | ED=4 WIRE D.=0.5 COMPRESSION SPRING | 2 | PZ | V11220A1 | 4,2X12 TCB SELF-TAPPING SCREW | 1 | PZ |
| Code      | Description                         | Qty   | UOM        |   |  |      |             |     |     |          |                               |   |    |          |                                     |   |    |          |                               |   |    |
| 0B1126A0  | DOOR LOWER FRAME SHAPE 860 MM       | 1   | PZ         |   |  |      |             |     |     |          |                               |   |    |          |                                     |   |    |          |                               |   |    |
| RC1200A0  | ED=4 WIRE D.=0.5 COMPRESSION SPRING | 2   | PZ         |   |  |      |             |     |     |          |                               |   |    |          |                                     |   |    |          |                               |   |    |
| V11220A1  | 4,2X12 TCB SELF-TAPPING SCREW       | 1   | PZ         |   |  |      |             |     |     |          |                               |   |    |          |                                     |   |    |          |                               |   |    |



| COMPONENT |  |   | SPARE PART |   |  |      |             |                                     |     |          |             |  |    |          |                             |                                      |    |          |            |             |    |          |                                    |                             |    |          |                                     |            |    |          |  |  |    |          |  |  |    |          |                    |                    |    |          |                                     |                                     |    |    |
|-----------|--|---|------------|---|--|------|-------------|-------------------------------------|-----|----------|-------------|--|----|----------|-----------------------------|--------------------------------------|----|----------|------------|-------------|----|----------|------------------------------------|-----------------------------|----|----------|-------------------------------------|------------|----|----------|--|--|----|----------|--|--|----|----------|--------------------|--------------------|----|----------|-------------------------------------|-------------------------------------|----|----|
| Code      | Description                                      | Image   | Code       | Description                                 | Components list  |      |             |                                     |     |          |             |  |    |          |                             |                                      |    |          |            |             |    |          |                                    |                             |    |          |                                     |            |    |          |  |  |    |          |  |  |    |          |                    |                    |    |          |                                     |                                     |    |    |
| VM2274A   | GROOVED BUSHING                                  |    | K0B1126AR  | BAKERTOP MM<br>RIGHT DOOR<br>LOWER BEAM KIT | <table border="1"> <thead> <tr> <th>Code</th> <th>Description</th> <th>Qty</th> <th>UOM</th> </tr> </thead> <tbody> <tr> <td>VI1996A0</td> <td>M5X35 SCREW</td> <td>7</td> <td>PZ</td> </tr> <tr> <td>VM1794A0</td> <td>250X4.8 PA66<br/>BLACK CLAMP</td> <td>2</td> <td>PZ</td> </tr> <tr> <td>VM2103A0</td> <td>CLAMP LOCK</td> <td>2</td> <td>PZ</td> </tr> <tr> <td>VM2259A1</td> <td>6 SERIES<br/>DOOR LOWER<br/>LEFT CAP</td> <td>1</td> <td>PZ</td> </tr> <tr> <td>VM2261A1</td> <td>6 SERIES<br/>DOOR LOWER<br/>RIGHT CAP</td> <td>1</td> <td>PZ</td> </tr> <tr> <td>VM2267A0</td> <td>INTERNAL<br/>GLASS<br/>LOCKING<br/>SYSTEM<br/>SLIDER</td> <td>1</td> <td>PZ</td> </tr> <tr> <td>VM2269A0</td> <td>INTERNAL<br/>GLASS<br/>LOCKING<br/>SYSTEM CAP</td> <td>1</td> <td>PZ</td> </tr> <tr> <td>VM2274A0</td> <td>GROOVED<br/>BUSHING</td> <td>1</td> <td>PZ</td> </tr> <tr> <td>VM2305A0</td> <td>6 SERIES<br/>DOOR CAP<br/>FIXING PAWL</td> <td>7</td> <td>PZ</td> </tr> </tbody> </table> | Code | Description | Qty                                 | UOM | VI1996A0 | M5X35 SCREW | 7  | PZ | VM1794A0 | 250X4.8 PA66<br>BLACK CLAMP | 2                                    | PZ | VM2103A0 | CLAMP LOCK | 2           | PZ | VM2259A1 | 6 SERIES<br>DOOR LOWER<br>LEFT CAP | 1                           | PZ | VM2261A1 | 6 SERIES<br>DOOR LOWER<br>RIGHT CAP | 1          | PZ | VM2267A0 | INTERNAL<br>GLASS<br>LOCKING<br>SYSTEM<br>SLIDER | 1  | PZ | VM2269A0 | INTERNAL<br>GLASS<br>LOCKING<br>SYSTEM CAP | 1  | PZ | VM2274A0 | GROOVED<br>BUSHING | 1                  | PZ | VM2305A0 | 6 SERIES<br>DOOR CAP<br>FIXING PAWL | 7                                   | PZ |    |
|           |  |   | Code       | Description                                 | Qty  | UOM  |             |                                     |     |          |             |  |    |          |                             |                                      |    |          |            |             |    |          |                                    |                             |    |          |                                     |            |    |          |  |  |    |          |  |  |    |          |                    |                    |    |          |                                     |                                     |    |    |
| VI1996A0  | M5X35 SCREW                                      | 7   | PZ         |   |  |      |             |                                     |     |          |             |  |    |          |                             |                                      |    |          |            |             |    |          |                                    |                             |    |          |                                     |            |    |          |  |  |    |          |  |  |    |          |                    |                    |    |          |                                     |                                     |    |    |
| VM1794A0  | 250X4.8 PA66<br>BLACK CLAMP                      | 2   | PZ         |   |  |      |             |                                     |     |          |             |  |    |          |                             |                                      |    |          |            |             |    |          |                                    |                             |    |          |                                     |            |    |          |  |  |    |          |  |  |    |          |                    |                    |    |          |                                     |                                     |    |    |
| VM2103A0  | CLAMP LOCK                                       | 2   | PZ         |   |  |      |             |                                     |     |          |             |  |    |          |                             |                                      |    |          |            |             |    |          |                                    |                             |    |          |                                     |            |    |          |  |  |    |          |  |  |    |          |                    |                    |    |          |                                     |                                     |    |    |
| VM2259A1  | 6 SERIES<br>DOOR LOWER<br>LEFT CAP               | 1   | PZ         |   |  |      |             |                                     |     |          |             |  |    |          |                             |                                      |    |          |            |             |    |          |                                    |                             |    |          |                                     |            |    |          |  |  |    |          |  |  |    |          |                    |                    |    |          |                                     |                                     |    |    |
| VM2261A1  | 6 SERIES<br>DOOR LOWER<br>RIGHT CAP              | 1   | PZ         |   |  |      |             |                                     |     |          |             |  |    |          |                             |                                      |    |          |            |             |    |          |                                    |                             |    |          |                                     |            |    |          |  |  |    |          |  |  |    |          |                    |                    |    |          |                                     |                                     |    |    |
| VM2267A0  | INTERNAL<br>GLASS<br>LOCKING<br>SYSTEM<br>SLIDER | 1   | PZ         |   |  |      |             |                                     |     |          |             |  |    |          |                             |                                      |    |          |            |             |    |          |                                    |                             |    |          |                                     |            |    |          |  |  |    |          |  |  |    |          |                    |                    |    |          |                                     |                                     |    |    |
| VM2269A0  | INTERNAL<br>GLASS<br>LOCKING<br>SYSTEM CAP       | 1   | PZ         |   |  |      |             |                                     |     |          |             |  |    |          |                             |                                      |    |          |            |             |    |          |                                    |                             |    |          |                                     |            |    |          |  |  |    |          |  |  |    |          |                    |                    |    |          |                                     |                                     |    |    |
| VM2274A0  | GROOVED<br>BUSHING                               | 1   | PZ         |   |  |      |             |                                     |     |          |             |  |    |          |                             |                                      |    |          |            |             |    |          |                                    |                             |    |          |                                     |            |    |          |  |  |    |          |  |  |    |          |                    |                    |    |          |                                     |                                     |    |    |
| VM2305A0  | 6 SERIES<br>DOOR CAP<br>FIXING PAWL              | 7   | PZ         |   |  |      |             |                                     |     |          |             |  |    |          |                             |                                      |    |          |            |             |    |          |                                    |                             |    |          |                                     |            |    |          |  |  |    |          |  |  |    |          |                    |                    |    |          |                                     |                                     |    |    |
| K0B1126AL | EU AND 2/1 MM<br>LEFT DOOR LOWER<br>BEAM KIT     | <table border="1"> <thead> <tr> <th>Code</th> <th>Description</th> <th>Qty</th> <th>UOM</th> </tr> </thead> <tbody> <tr> <td>0B1126A0</td> <td>DOOR LOWER<br/>FRAME SHAPE<br/>860 MM</td> <td>1</td> <td>PZ</td> </tr> <tr> <td>RC1200A0</td> <td>ED=4 WIRE<br/>D.=0.5<br/>COMPRESSION<br/>N SPRING</td> <td>2</td> <td>PZ</td> </tr> <tr> <td>VI1220A1</td> <td>4,2X12 TCB<br/>SELF-TAPPIN<br/>G SCREW</td> <td>1</td> <td>PZ</td> </tr> <tr> <td>VI1996A0</td> <td>M5X35 SCREW</td> <td>7</td> <td>PZ</td> </tr> <tr> <td>VM1794A0</td> <td>250X4.8 PA66<br/>BLACK CLAMP</td> <td>2</td> <td>PZ</td> </tr> <tr> <td>VM2103A0</td> <td>CLAMP LOCK</td> <td>2</td> <td>PZ</td> </tr> <tr> <td>VM2267A0</td> <td>INTERNAL<br/>GLASS<br/>LOCKING<br/>SYSTEM<br/>SLIDER</td> <td>1</td> <td>PZ</td> </tr> <tr> <td>VM2269A0</td> <td>INTERNAL<br/>GLASS<br/>LOCKING<br/>SYSTEM CAP</td> <td>1</td> <td>PZ</td> </tr> <tr> <td>VM2274A0</td> <td>GROOVED<br/>BUSHING</td> <td>1</td> <td>PZ</td> </tr> <tr> <td>VM2305A0</td> <td>6 SERIES<br/>DOOR CAP<br/>FIXING PAWL</td> <td>7</td> <td>PZ</td> </tr> </tbody> </table> | Code       | Description                                 | Qty  | UOM  | 0B1126A0    | DOOR LOWER<br>FRAME SHAPE<br>860 MM | 1   | PZ       | RC1200A0    | ED=4 WIRE<br>D.=0.5<br>COMPRESSION<br>N SPRING | 2  | PZ       | VI1220A1                    | 4,2X12 TCB<br>SELF-TAPPIN<br>G SCREW | 1  | PZ       | VI1996A0   | M5X35 SCREW | 7  | PZ       | VM1794A0                           | 250X4.8 PA66<br>BLACK CLAMP | 2  | PZ       | VM2103A0                            | CLAMP LOCK | 2  | PZ       | VM2267A0   | INTERNAL<br>GLASS<br>LOCKING<br>SYSTEM<br>SLIDER | 1  | PZ       | VM2269A0                                   | INTERNAL<br>GLASS<br>LOCKING<br>SYSTEM CAP | 1  | PZ       | VM2274A0           | GROOVED<br>BUSHING | 1  | PZ       | VM2305A0                            | 6 SERIES<br>DOOR CAP<br>FIXING PAWL | 7  | PZ |
| Code      | Description                                      | Qty   | UOM        |   |  |      |             |                                     |     |          |             |  |    |          |                             |                                      |    |          |            |             |    |          |                                    |                             |    |          |                                     |            |    |          |  |  |    |          |  |  |    |          |                    |                    |    |          |                                     |                                     |    |    |
| 0B1126A0  | DOOR LOWER<br>FRAME SHAPE<br>860 MM              | 1   | PZ         |   |  |      |             |                                     |     |          |             |  |    |          |                             |                                      |    |          |            |             |    |          |                                    |                             |    |          |                                     |            |    |          |  |  |    |          |  |  |    |          |                    |                    |    |          |                                     |                                     |    |    |
| RC1200A0  | ED=4 WIRE<br>D.=0.5<br>COMPRESSION<br>N SPRING   | 2   | PZ         |   |  |      |             |                                     |     |          |             |  |    |          |                             |                                      |    |          |            |             |    |          |                                    |                             |    |          |                                     |            |    |          |  |  |    |          |  |  |    |          |                    |                    |    |          |                                     |                                     |    |    |
| VI1220A1  | 4,2X12 TCB<br>SELF-TAPPIN<br>G SCREW             | 1   | PZ         |   |  |      |             |                                     |     |          |             |  |    |          |                             |                                      |    |          |            |             |    |          |                                    |                             |    |          |                                     |            |    |          |  |  |    |          |  |  |    |          |                    |                    |    |          |                                     |                                     |    |    |
| VI1996A0  | M5X35 SCREW                                      | 7   | PZ         |   |  |      |             |                                     |     |          |             |  |    |          |                             |                                      |    |          |            |             |    |          |                                    |                             |    |          |                                     |            |    |          |  |  |    |          |  |  |    |          |                    |                    |    |          |                                     |                                     |    |    |
| VM1794A0  | 250X4.8 PA66<br>BLACK CLAMP                      | 2   | PZ         |   |  |      |             |                                     |     |          |             |  |    |          |                             |                                      |    |          |            |             |    |          |                                    |                             |    |          |                                     |            |    |          |  |  |    |          |  |  |    |          |                    |                    |    |          |                                     |                                     |    |    |
| VM2103A0  | CLAMP LOCK                                       | 2   | PZ         |   |  |      |             |                                     |     |          |             |  |    |          |                             |                                      |    |          |            |             |    |          |                                    |                             |    |          |                                     |            |    |          |  |  |    |          |  |  |    |          |                    |                    |    |          |                                     |                                     |    |    |
| VM2267A0  | INTERNAL<br>GLASS<br>LOCKING<br>SYSTEM<br>SLIDER | 1   | PZ         |   |  |      |             |                                     |     |          |             |  |    |          |                             |                                      |    |          |            |             |    |          |                                    |                             |    |          |                                     |            |    |          |  |  |    |          |  |  |    |          |                    |                    |    |          |                                     |                                     |    |    |
| VM2269A0  | INTERNAL<br>GLASS<br>LOCKING<br>SYSTEM CAP       | 1   | PZ         |   |  |      |             |                                     |     |          |             |  |    |          |                             |                                      |    |          |            |             |    |          |                                    |                             |    |          |                                     |            |    |          |  |  |    |          |  |  |    |          |                    |                    |    |          |                                     |                                     |    |    |
| VM2274A0  | GROOVED<br>BUSHING                               | 1   | PZ         |   |  |      |             |                                     |     |          |             |  |    |          |                             |                                      |    |          |            |             |    |          |                                    |                             |    |          |                                     |            |    |          |  |  |    |          |  |  |    |          |                    |                    |    |          |                                     |                                     |    |    |
| VM2305A0  | 6 SERIES<br>DOOR CAP<br>FIXING PAWL              | 7   | PZ         |   |  |      |             |                                     |     |          |             |  |    |          |                             |                                      |    |          |            |             |    |          |                                    |                             |    |          |                                     |            |    |          |  |  |    |          |  |  |    |          |                    |                    |    |          |                                     |                                     |    |    |

| COMPONENT |  |   | SPARE PART |  |   |      |             |                                       |     |          |                                    |   |    |          |                                    |                                      |    |          |                                   |             |    |          |                                   |                             |    |    |          |            |   |    |          |                                    |   |    |          |                                     |   |    |          |  |   |    |          |  |   |    |          |                    |   |    |          |                                     |   |    |
|-----------|--|---|------------|--|---|------|-------------|---------------------------------------|-----|----------|------------------------------------|---|----|----------|------------------------------------|--------------------------------------|----|----------|-----------------------------------|-------------|----|----------|-----------------------------------|-----------------------------|----|----|----------|------------|---|----|----------|------------------------------------|---|----|----------|-------------------------------------|---|----|----------|--|---|----|----------|--|---|----|----------|--------------------|---|----|----------|-------------------------------------|---|----|
| Code      | Description                                      | Image   | Code       | Description                                  | Components list   |      |             |                                       |     |          |                                    |   |    |          |                                    |                                      |    |          |                                   |             |    |          |                                   |                             |    |    |          |            |   |    |          |                                    |   |    |          |                                     |   |    |          |  |   |    |          |  |   |    |          |                    |   |    |          |                                     |   |    |
| VM2274A   | GROOVED BUSHING                                  |    | K0B1126AL  | EU AND 2/1 MM<br>LEFT DOOR LOWER<br>BEAM KIT | <table border="1"> <thead> <tr> <th>Code</th> <th>Description</th> <th>Qty</th> <th>UOM</th> </tr> </thead> <tbody> <tr> <td>VM2384A0</td> <td>LEFT MM<br/>DOOR LOWER<br/>RIGHT CAP</td> <td>1</td> <td>PZ</td> </tr> <tr> <td>VM2384A0</td> <td>LEFT MM<br/>DOOR LOWER<br/>RIGHT CAP</td> <td>1</td> <td>PZ</td> </tr> <tr> <td>VM2386A1</td> <td>LEFT MM<br/>DOOR LOWER<br/>LEFT CAP</td> <td>1</td> <td>PZ</td> </tr> <tr> <td>VM2386A1</td> <td>LEFT MM<br/>DOOR LOWER<br/>LEFT CAP</td> <td>1</td> <td>PZ</td> </tr> </tbody> </table> | Code | Description | Qty                                   | UOM | VM2384A0 | LEFT MM<br>DOOR LOWER<br>RIGHT CAP | 1   | PZ | VM2384A0 | LEFT MM<br>DOOR LOWER<br>RIGHT CAP | 1                                    | PZ | VM2386A1 | LEFT MM<br>DOOR LOWER<br>LEFT CAP | 1           | PZ | VM2386A1 | LEFT MM<br>DOOR LOWER<br>LEFT CAP | 1                           | PZ |    |          |            |   |    |          |                                    |   |    |          |                                     |   |    |          |  |   |    |          |  |   |    |          |                    |   |    |          |                                     |   |    |
|           |  |   | Code       | Description                                  | Qty   | UOM  |             |                                       |     |          |                                    |   |    |          |                                    |                                      |    |          |                                   |             |    |          |                                   |                             |    |    |          |            |   |    |          |                                    |   |    |          |                                     |   |    |          |  |   |    |          |  |   |    |          |                    |   |    |          |                                     |   |    |
| VM2384A0  | LEFT MM<br>DOOR LOWER<br>RIGHT CAP               | 1   | PZ         |  |   |      |             |                                       |     |          |                                    |   |    |          |                                    |                                      |    |          |                                   |             |    |          |                                   |                             |    |    |          |            |   |    |          |                                    |   |    |          |                                     |   |    |          |  |   |    |          |  |   |    |          |                    |   |    |          |                                     |   |    |
| VM2384A0  | LEFT MM<br>DOOR LOWER<br>RIGHT CAP               | 1   | PZ         |  |   |      |             |                                       |     |          |                                    |   |    |          |                                    |                                      |    |          |                                   |             |    |          |                                   |                             |    |    |          |            |   |    |          |                                    |   |    |          |                                     |   |    |          |  |   |    |          |  |   |    |          |                    |   |    |          |                                     |   |    |
| VM2386A1  | LEFT MM<br>DOOR LOWER<br>LEFT CAP                | 1   | PZ         |  |   |      |             |                                       |     |          |                                    |   |    |          |                                    |                                      |    |          |                                   |             |    |          |                                   |                             |    |    |          |            |   |    |          |                                    |   |    |          |                                     |   |    |          |  |   |    |          |  |   |    |          |                    |   |    |          |                                     |   |    |
| VM2386A1  | LEFT MM<br>DOOR LOWER<br>LEFT CAP                | 1   | PZ         |  |   |      |             |                                       |     |          |                                    |   |    |          |                                    |                                      |    |          |                                   |             |    |          |                                   |                             |    |    |          |            |   |    |          |                                    |   |    |          |                                     |   |    |          |  |   |    |          |  |   |    |          |                    |   |    |          |                                     |   |    |
| K0B1122AR | CHEFTOP MM<br>RIGHT DOOR<br>LOWER BEAM KIT       | <table border="1"> <thead> <tr> <th>Code</th> <th>Description</th> <th>Qty</th> <th>UOM</th> </tr> </thead> <tbody> <tr> <td>0B1122A0</td> <td>6 SERIES<br/>DOOR LOWER<br/>FRAME SHAPE</td> <td>1</td> <td>PZ</td> </tr> <tr> <td>RC1200A0</td> <td>ED=4 WIRE<br/>D.=0.5<br/>COMPRESSIO<br/>N SPRING</td> <td>2</td> <td>PZ</td> </tr> <tr> <td>VH1220A1</td> <td>4,2X12 TCB<br/>SELF-TAPPIN<br/>G SCREW</td> <td>1</td> <td>PZ</td> </tr> <tr> <td>VI1996A0</td> <td>M5X35 SCREW</td> <td>7</td> <td>PZ</td> </tr> <tr> <td>VM1794A0</td> <td>250X4.8 PA66<br/>BLACK CLAMP</td> <td>2</td> <td>PZ</td> </tr> <tr> <td>VM2103A0</td> <td>CLAMP LOCK</td> <td>2</td> <td>PZ</td> </tr> <tr> <td>VM2259A1</td> <td>6 SERIES<br/>DOOR LOWER<br/>LEFT CAP</td> <td>1</td> <td>PZ</td> </tr> <tr> <td>VM2261A1</td> <td>6 SERIES<br/>DOOR LOWER<br/>RIGHT CAP</td> <td>1</td> <td>PZ</td> </tr> <tr> <td>VM2267A0</td> <td>INTERNAL<br/>GLASS<br/>LOCKING<br/>SYSTEM<br/>SLIDER</td> <td>1</td> <td>PZ</td> </tr> <tr> <td>VM2269A0</td> <td>INTERNAL<br/>GLASS<br/>LOCKING<br/>SYSTEM CAP</td> <td>1</td> <td>PZ</td> </tr> <tr> <td>VM2274A0</td> <td>GROOVED<br/>BUSHING</td> <td>1</td> <td>PZ</td> </tr> <tr> <td>VM2305A0</td> <td>6 SERIES<br/>DOOR CAP<br/>FIXING PAWL</td> <td>7</td> <td>PZ</td> </tr> </tbody> </table> | Code       | Description                                  | Qty   | UOM  | 0B1122A0    | 6 SERIES<br>DOOR LOWER<br>FRAME SHAPE | 1   | PZ       | RC1200A0                           | ED=4 WIRE<br>D.=0.5<br>COMPRESSIO<br>N SPRING | 2  | PZ       | VH1220A1                           | 4,2X12 TCB<br>SELF-TAPPIN<br>G SCREW | 1  | PZ       | VI1996A0                          | M5X35 SCREW | 7  | PZ       | VM1794A0                          | 250X4.8 PA66<br>BLACK CLAMP | 2  | PZ | VM2103A0 | CLAMP LOCK | 2 | PZ | VM2259A1 | 6 SERIES<br>DOOR LOWER<br>LEFT CAP | 1 | PZ | VM2261A1 | 6 SERIES<br>DOOR LOWER<br>RIGHT CAP | 1 | PZ | VM2267A0 | INTERNAL<br>GLASS<br>LOCKING<br>SYSTEM<br>SLIDER | 1 | PZ | VM2269A0 | INTERNAL<br>GLASS<br>LOCKING<br>SYSTEM CAP | 1 | PZ | VM2274A0 | GROOVED<br>BUSHING | 1 | PZ | VM2305A0 | 6 SERIES<br>DOOR CAP<br>FIXING PAWL | 7 | PZ |
| Code      | Description                                      | Qty   | UOM        |  |   |      |             |                                       |     |          |                                    |   |    |          |                                    |                                      |    |          |                                   |             |    |          |                                   |                             |    |    |          |            |   |    |          |                                    |   |    |          |                                     |   |    |          |  |   |    |          |  |   |    |          |                    |   |    |          |                                     |   |    |
| 0B1122A0  | 6 SERIES<br>DOOR LOWER<br>FRAME SHAPE            | 1   | PZ         |  |   |      |             |                                       |     |          |                                    |   |    |          |                                    |                                      |    |          |                                   |             |    |          |                                   |                             |    |    |          |            |   |    |          |                                    |   |    |          |                                     |   |    |          |  |   |    |          |  |   |    |          |                    |   |    |          |                                     |   |    |
| RC1200A0  | ED=4 WIRE<br>D.=0.5<br>COMPRESSIO<br>N SPRING    | 2   | PZ         |  |   |      |             |                                       |     |          |                                    |   |    |          |                                    |                                      |    |          |                                   |             |    |          |                                   |                             |    |    |          |            |   |    |          |                                    |   |    |          |                                     |   |    |          |  |   |    |          |  |   |    |          |                    |   |    |          |                                     |   |    |
| VH1220A1  | 4,2X12 TCB<br>SELF-TAPPIN<br>G SCREW             | 1   | PZ         |  |   |      |             |                                       |     |          |                                    |   |    |          |                                    |                                      |    |          |                                   |             |    |          |                                   |                             |    |    |          |            |   |    |          |                                    |   |    |          |                                     |   |    |          |  |   |    |          |  |   |    |          |                    |   |    |          |                                     |   |    |
| VI1996A0  | M5X35 SCREW                                      | 7   | PZ         |  |   |      |             |                                       |     |          |                                    |   |    |          |                                    |                                      |    |          |                                   |             |    |          |                                   |                             |    |    |          |            |   |    |          |                                    |   |    |          |                                     |   |    |          |  |   |    |          |  |   |    |          |                    |   |    |          |                                     |   |    |
| VM1794A0  | 250X4.8 PA66<br>BLACK CLAMP                      | 2   | PZ         |  |   |      |             |                                       |     |          |                                    |   |    |          |                                    |                                      |    |          |                                   |             |    |          |                                   |                             |    |    |          |            |   |    |          |                                    |   |    |          |                                     |   |    |          |  |   |    |          |  |   |    |          |                    |   |    |          |                                     |   |    |
| VM2103A0  | CLAMP LOCK                                       | 2   | PZ         |  |   |      |             |                                       |     |          |                                    |   |    |          |                                    |                                      |    |          |                                   |             |    |          |                                   |                             |    |    |          |            |   |    |          |                                    |   |    |          |                                     |   |    |          |  |   |    |          |  |   |    |          |                    |   |    |          |                                     |   |    |
| VM2259A1  | 6 SERIES<br>DOOR LOWER<br>LEFT CAP               | 1   | PZ         |  |   |      |             |                                       |     |          |                                    |   |    |          |                                    |                                      |    |          |                                   |             |    |          |                                   |                             |    |    |          |            |   |    |          |                                    |   |    |          |                                     |   |    |          |  |   |    |          |  |   |    |          |                    |   |    |          |                                     |   |    |
| VM2261A1  | 6 SERIES<br>DOOR LOWER<br>RIGHT CAP              | 1   | PZ         |  |   |      |             |                                       |     |          |                                    |   |    |          |                                    |                                      |    |          |                                   |             |    |          |                                   |                             |    |    |          |            |   |    |          |                                    |   |    |          |                                     |   |    |          |  |   |    |          |  |   |    |          |                    |   |    |          |                                     |   |    |
| VM2267A0  | INTERNAL<br>GLASS<br>LOCKING<br>SYSTEM<br>SLIDER | 1   | PZ         |  |   |      |             |                                       |     |          |                                    |   |    |          |                                    |                                      |    |          |                                   |             |    |          |                                   |                             |    |    |          |            |   |    |          |                                    |   |    |          |                                     |   |    |          |  |   |    |          |  |   |    |          |                    |   |    |          |                                     |   |    |
| VM2269A0  | INTERNAL<br>GLASS<br>LOCKING<br>SYSTEM CAP       | 1   | PZ         |  |   |      |             |                                       |     |          |                                    |   |    |          |                                    |                                      |    |          |                                   |             |    |          |                                   |                             |    |    |          |            |   |    |          |                                    |   |    |          |                                     |   |    |          |  |   |    |          |  |   |    |          |                    |   |    |          |                                     |   |    |
| VM2274A0  | GROOVED<br>BUSHING                               | 1   | PZ         |  |   |      |             |                                       |     |          |                                    |   |    |          |                                    |                                      |    |          |                                   |             |    |          |                                   |                             |    |    |          |            |   |    |          |                                    |   |    |          |                                     |   |    |          |  |   |    |          |  |   |    |          |                    |   |    |          |                                     |   |    |
| VM2305A0  | 6 SERIES<br>DOOR CAP<br>FIXING PAWL              | 7   | PZ         |  |   |      |             |                                       |     |          |                                    |   |    |          |                                    |                                      |    |          |                                   |             |    |          |                                   |                             |    |    |          |            |   |    |          |                                    |   |    |          |                                     |   |    |          |  |   |    |          |  |   |    |          |                    |   |    |          |                                     |   |    |
| K0B1122AL | CHEFTOP MM LEFT<br>DOOR LOWER<br>BEAM KIT        | <table border="1"> <thead> <tr> <th>Code</th> <th>Description</th> <th>Qty</th> <th>UOM</th> </tr> </thead> <tbody> <tr> <td>0B1122A0</td> <td>6 SERIES<br/>DOOR LOWER<br/>FRAME SHAPE</td> <td>1</td> <td>PZ</td> </tr> </tbody> </table>  | Code       | Description                                  | Qty   | UOM  | 0B1122A0    | 6 SERIES<br>DOOR LOWER<br>FRAME SHAPE | 1   | PZ       |                                    |   |    |          |                                    |                                      |    |          |                                   |             |    |          |                                   |                             |    |    |          |            |   |    |          |                                    |   |    |          |                                     |   |    |          |  |   |    |          |  |   |    |          |                    |   |    |          |                                     |   |    |
| Code      | Description                                      | Qty   | UOM        |  |   |      |             |                                       |     |          |                                    |   |    |          |                                    |                                      |    |          |                                   |             |    |          |                                   |                             |    |    |          |            |   |    |          |                                    |   |    |          |                                     |   |    |          |  |   |    |          |  |   |    |          |                    |   |    |          |                                     |   |    |
| 0B1122A0  | 6 SERIES<br>DOOR LOWER<br>FRAME SHAPE            | 1   | PZ         |  |   |      |             |                                       |     |          |                                    |   |    |          |                                    |                                      |    |          |                                   |             |    |          |                                   |                             |    |    |          |            |   |    |          |                                    |   |    |          |                                     |   |    |          |  |   |    |          |  |   |    |          |                    |   |    |          |                                     |   |    |



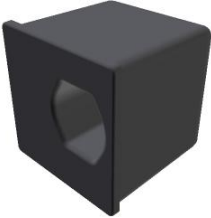

| COMPONENT |  |   | SPARE PART |                                     |   |      |             |     |     |          |   |   |    |          |                                      |   |    |          |             |   |    |          |                             |   |    |          |            |   |    |          |  |   |    |          |  |   |    |          |                    |   |    |          |                                     |   |    |          |                                    |   |    |          |                                    |   |    |          |                                   |   |    |          |                                   |   |    |
|-----------|--|---|------------|-------------------------------------|---|------|-------------|-----|-----|----------|---|---|----|----------|--------------------------------------|---|----|----------|-------------|---|----|----------|-----------------------------|---|----|----------|------------|---|----|----------|--|---|----|----------|--|---|----|----------|--------------------|---|----|----------|-------------------------------------|---|----|----------|------------------------------------|---|----|----------|------------------------------------|---|----|----------|-----------------------------------|---|----|----------|-----------------------------------|---|----|
| Code      | Description                                      | Image   | Code       | Description                         | Components list   |      |             |     |     |          |   |   |    |          |                                      |   |    |          |             |   |    |          |                             |   |    |          |            |   |    |          |  |   |    |          |  |   |    |          |                    |   |    |          |                                     |   |    |          |                                    |   |    |          |                                    |   |    |          |                                   |   |    |          |                                   |   |    |
| VM2274A   | GROOVED BUSHING                                  |    | K0B1122AL  | CHEFTOP MM LEFT DOOR LOWER BEAM KIT | <table border="1"> <thead> <tr> <th>Code</th> <th>Description</th> <th>Qty</th> <th>UOM</th> </tr> </thead> <tbody> <tr> <td>RC1200A0</td> <td>ED=4 WIRE<br/>D.=0.5<br/>COMPRESSIO<br/>N SPRING</td> <td>2</td> <td>PZ</td> </tr> <tr> <td>V11220A1</td> <td>4,2X12 TCB<br/>SELF-TAPPIN<br/>G SCREW</td> <td>1</td> <td>PZ</td> </tr> <tr> <td>V11996A0</td> <td>M5X35 SCREW</td> <td>7</td> <td>PZ</td> </tr> <tr> <td>VM1794A0</td> <td>250X4.8 PA66<br/>BLACK CLAMP</td> <td>2</td> <td>PZ</td> </tr> <tr> <td>VM2103A0</td> <td>CLAMP LOCK</td> <td>2</td> <td>PZ</td> </tr> <tr> <td>VM2267A0</td> <td>INTERNAL<br/>GLASS<br/>LOCKING<br/>SYSTEM<br/>SLIDER</td> <td>1</td> <td>PZ</td> </tr> <tr> <td>VM2269A0</td> <td>INTERNAL<br/>GLASS<br/>LOCKING<br/>SYSTEM CAP</td> <td>1</td> <td>PZ</td> </tr> <tr> <td>VM2274A0</td> <td>GROOVED<br/>BUSHING</td> <td>1</td> <td>PZ</td> </tr> <tr> <td>VM2305A0</td> <td>6 SERIES<br/>DOOR CAP<br/>FIXING PAWL</td> <td>7</td> <td>PZ</td> </tr> <tr> <td>VM2384A0</td> <td>LEFT MM<br/>DOOR LOWER<br/>RIGHT CAP</td> <td>1</td> <td>PZ</td> </tr> <tr> <td>VM2384A0</td> <td>LEFT MM<br/>DOOR LOWER<br/>RIGHT CAP</td> <td>1</td> <td>PZ</td> </tr> <tr> <td>VM2386A1</td> <td>LEFT MM<br/>DOOR LOWER<br/>LEFT CAP</td> <td>1</td> <td>PZ</td> </tr> <tr> <td>VM2386A1</td> <td>LEFT MM<br/>DOOR LOWER<br/>LEFT CAP</td> <td>1</td> <td>PZ</td> </tr> </tbody> </table> | Code | Description | Qty | UOM | RC1200A0 | ED=4 WIRE<br>D.=0.5<br>COMPRESSIO<br>N SPRING | 2 | PZ | V11220A1 | 4,2X12 TCB<br>SELF-TAPPIN<br>G SCREW | 1 | PZ | V11996A0 | M5X35 SCREW | 7 | PZ | VM1794A0 | 250X4.8 PA66<br>BLACK CLAMP | 2 | PZ | VM2103A0 | CLAMP LOCK | 2 | PZ | VM2267A0 | INTERNAL<br>GLASS<br>LOCKING<br>SYSTEM<br>SLIDER | 1 | PZ | VM2269A0 | INTERNAL<br>GLASS<br>LOCKING<br>SYSTEM CAP | 1 | PZ | VM2274A0 | GROOVED<br>BUSHING | 1 | PZ | VM2305A0 | 6 SERIES<br>DOOR CAP<br>FIXING PAWL | 7 | PZ | VM2384A0 | LEFT MM<br>DOOR LOWER<br>RIGHT CAP | 1 | PZ | VM2384A0 | LEFT MM<br>DOOR LOWER<br>RIGHT CAP | 1 | PZ | VM2386A1 | LEFT MM<br>DOOR LOWER<br>LEFT CAP | 1 | PZ | VM2386A1 | LEFT MM<br>DOOR LOWER<br>LEFT CAP | 1 | PZ |
| Code      | Description                                      | Qty   | UOM        |                                     |   |      |             |     |     |          |   |   |    |          |                                      |   |    |          |             |   |    |          |                             |   |    |          |            |   |    |          |  |   |    |          |  |   |    |          |                    |   |    |          |                                     |   |    |          |                                    |   |    |          |                                    |   |    |          |                                   |   |    |          |                                   |   |    |
| RC1200A0  | ED=4 WIRE<br>D.=0.5<br>COMPRESSIO<br>N SPRING    | 2   | PZ         |                                     |   |      |             |     |     |          |   |   |    |          |                                      |   |    |          |             |   |    |          |                             |   |    |          |            |   |    |          |  |   |    |          |  |   |    |          |                    |   |    |          |                                     |   |    |          |                                    |   |    |          |                                    |   |    |          |                                   |   |    |          |                                   |   |    |
| V11220A1  | 4,2X12 TCB<br>SELF-TAPPIN<br>G SCREW             | 1   | PZ         |                                     |   |      |             |     |     |          |   |   |    |          |                                      |   |    |          |             |   |    |          |                             |   |    |          |            |   |    |          |  |   |    |          |  |   |    |          |                    |   |    |          |                                     |   |    |          |                                    |   |    |          |                                    |   |    |          |                                   |   |    |          |                                   |   |    |
| V11996A0  | M5X35 SCREW                                      | 7   | PZ         |                                     |   |      |             |     |     |          |   |   |    |          |                                      |   |    |          |             |   |    |          |                             |   |    |          |            |   |    |          |  |   |    |          |  |   |    |          |                    |   |    |          |                                     |   |    |          |                                    |   |    |          |                                    |   |    |          |                                   |   |    |          |                                   |   |    |
| VM1794A0  | 250X4.8 PA66<br>BLACK CLAMP                      | 2   | PZ         |                                     |   |      |             |     |     |          |   |   |    |          |                                      |   |    |          |             |   |    |          |                             |   |    |          |            |   |    |          |  |   |    |          |  |   |    |          |                    |   |    |          |                                     |   |    |          |                                    |   |    |          |                                    |   |    |          |                                   |   |    |          |                                   |   |    |
| VM2103A0  | CLAMP LOCK                                       | 2   | PZ         |                                     |   |      |             |     |     |          |   |   |    |          |                                      |   |    |          |             |   |    |          |                             |   |    |          |            |   |    |          |  |   |    |          |  |   |    |          |                    |   |    |          |                                     |   |    |          |                                    |   |    |          |                                    |   |    |          |                                   |   |    |          |                                   |   |    |
| VM2267A0  | INTERNAL<br>GLASS<br>LOCKING<br>SYSTEM<br>SLIDER | 1   | PZ         |                                     |   |      |             |     |     |          |   |   |    |          |                                      |   |    |          |             |   |    |          |                             |   |    |          |            |   |    |          |  |   |    |          |  |   |    |          |                    |   |    |          |                                     |   |    |          |                                    |   |    |          |                                    |   |    |          |                                   |   |    |          |                                   |   |    |
| VM2269A0  | INTERNAL<br>GLASS<br>LOCKING<br>SYSTEM CAP       | 1   | PZ         |                                     |   |      |             |     |     |          |   |   |    |          |                                      |   |    |          |             |   |    |          |                             |   |    |          |            |   |    |          |  |   |    |          |  |   |    |          |                    |   |    |          |                                     |   |    |          |                                    |   |    |          |                                    |   |    |          |                                   |   |    |          |                                   |   |    |
| VM2274A0  | GROOVED<br>BUSHING                               | 1   | PZ         |                                     |   |      |             |     |     |          |   |   |    |          |                                      |   |    |          |             |   |    |          |                             |   |    |          |            |   |    |          |  |   |    |          |  |   |    |          |                    |   |    |          |                                     |   |    |          |                                    |   |    |          |                                    |   |    |          |                                   |   |    |          |                                   |   |    |
| VM2305A0  | 6 SERIES<br>DOOR CAP<br>FIXING PAWL              | 7   | PZ         |                                     |   |      |             |     |     |          |   |   |    |          |                                      |   |    |          |             |   |    |          |                             |   |    |          |            |   |    |          |  |   |    |          |  |   |    |          |                    |   |    |          |                                     |   |    |          |                                    |   |    |          |                                    |   |    |          |                                   |   |    |          |                                   |   |    |
| VM2384A0  | LEFT MM<br>DOOR LOWER<br>RIGHT CAP               | 1   | PZ         |                                     |   |      |             |     |     |          |   |   |    |          |                                      |   |    |          |             |   |    |          |                             |   |    |          |            |   |    |          |  |   |    |          |  |   |    |          |                    |   |    |          |                                     |   |    |          |                                    |   |    |          |                                    |   |    |          |                                   |   |    |          |                                   |   |    |
| VM2384A0  | LEFT MM<br>DOOR LOWER<br>RIGHT CAP               | 1   | PZ         |                                     |   |      |             |     |     |          |   |   |    |          |                                      |   |    |          |             |   |    |          |                             |   |    |          |            |   |    |          |  |   |    |          |  |   |    |          |                    |   |    |          |                                     |   |    |          |                                    |   |    |          |                                    |   |    |          |                                   |   |    |          |                                   |   |    |
| VM2386A1  | LEFT MM<br>DOOR LOWER<br>LEFT CAP                | 1   | PZ         |                                     |   |      |             |     |     |          |   |   |    |          |                                      |   |    |          |             |   |    |          |                             |   |    |          |            |   |    |          |  |   |    |          |  |   |    |          |                    |   |    |          |                                     |   |    |          |                                    |   |    |          |                                    |   |    |          |                                   |   |    |          |                                   |   |    |
| VM2386A1  | LEFT MM<br>DOOR LOWER<br>LEFT CAP                | 1   | PZ         |                                     |   |      |             |     |     |          |   |   |    |          |                                      |   |    |          |             |   |    |          |                             |   |    |          |            |   |    |          |  |   |    |          |  |   |    |          |                    |   |    |          |                                     |   |    |          |                                    |   |    |          |                                    |   |    |          |                                   |   |    |          |                                   |   |    |
| VM2263A   | MM BIG DOOR LOWER LEFT CAP                       |  | KVM2263A   | MM BIG DOOR LEFT LOWER CAP KIT      | <table border="1"> <thead> <tr> <th>Code</th> <th>Description</th> <th>Qty</th> <th>UOM</th> </tr> </thead> <tbody> <tr> <td>VM2263A0</td> <td>MM BIG DOOR<br/>LOWER LEFT<br/>CAP</td> <td>1</td> <td>PZ</td> </tr> </tbody> </table>   | Code | Description | Qty | UOM | VM2263A0 | MM BIG DOOR<br>LOWER LEFT<br>CAP              | 1 | PZ |          |                                      |   |    |          |             |   |    |          |                             |   |    |          |            |   |    |          |  |   |    |          |  |   |    |          |                    |   |    |          |                                     |   |    |          |                                    |   |    |          |                                    |   |    |          |                                   |   |    |          |                                   |   |    |
| Code      | Description                                      | Qty   | UOM        |                                     |   |      |             |     |     |          |   |   |    |          |                                      |   |    |          |             |   |    |          |                             |   |    |          |            |   |    |          |  |   |    |          |  |   |    |          |                    |   |    |          |                                     |   |    |          |                                    |   |    |          |                                    |   |    |          |                                   |   |    |          |                                   |   |    |
| VM2263A0  | MM BIG DOOR<br>LOWER LEFT<br>CAP                 | 1   | PZ         |                                     |   |      |             |     |     |          |   |   |    |          |                                      |   |    |          |             |   |    |          |                             |   |    |          |            |   |    |          |  |   |    |          |  |   |    |          |                    |   |    |          |                                     |   |    |          |                                    |   |    |          |                                    |   |    |          |                                   |   |    |          |                                   |   |    |







| COMPONENT |   |   | SPARE PART |  |  |      |             |     |     |          |   |       |    |          |                                     |   |    |          |                       |       |   |
|-----------|---|---|------------|--|--|------|-------------|-----|-----|----------|---|-------|----|----------|-------------------------------------|---|----|----------|-----------------------|-------|---|
| Code      | Description                             | Image   | Code       | Description                              | Components list  |      |             |     |     |          |   |       |    |          |                                     |   |    |          |                       |       |   |
| VM2268A   | DOOR MAGNET COVER                       |    | KVM2268A   | DOOR MAGNET COVER KIT                    | <table border="1"> <thead> <tr> <th>Code</th> <th>Description</th> <th>Qty</th> <th>UOM</th> </tr> </thead> <tbody> <tr> <td>VM2268A0</td> <td>DOOR MAGNET COVER</td> <td>1</td> <td>PZ</td> </tr> </tbody> </table>   | Code | Description | Qty | UOM | VM2268A0 | DOOR MAGNET COVER                       | 1     | PZ |          |                                     |   |    |          |                       |       |   |
| Code      | Description                             | Qty   | UOM        |  |  |      |             |     |     |          |   |       |    |          |                                     |   |    |          |                       |       |   |
| VM2268A0  | DOOR MAGNET COVER                       | 1   | PZ         |  |  |      |             |     |     |          |   |       |    |          |                                     |   |    |          |                       |       |   |
| VM2265A   | MM BIG DOOR LOWER RIGHT CAP             |    | KVM2265A   | MM TROLLEY OVEN DOOR RIGHT LOWER CAP KIT | <table border="1"> <thead> <tr> <th>Code</th> <th>Description</th> <th>Qty</th> <th>UOM</th> </tr> </thead> <tbody> <tr> <td>VM2265A0</td> <td>MM BIG DOOR LOWER RIGHT CAP</td> <td>1</td> <td>PZ</td> </tr> </tbody> </table>   | Code | Description | Qty | UOM | VM2265A0 | MM BIG DOOR LOWER RIGHT CAP             | 1     | PZ |          |                                     |   |    |          |                       |       |   |
| Code      | Description                             | Qty   | UOM        |  |  |      |             |     |     |          |   |       |    |          |                                     |   |    |          |                       |       |   |
| VM2265A0  | MM BIG DOOR LOWER RIGHT CAP             | 1   | PZ         |  |  |      |             |     |     |          |   |       |    |          |                                     |   |    |          |                       |       |   |
| LP1029A   | L=1199 S6 NO LED LIGHT BAR COVER        |  | KLP1029A   | L119 MM NO LED LIGHT HOLDER KIT          | <table border="1"> <thead> <tr> <th>Code</th> <th>Description</th> <th>Qty</th> <th>UOM</th> </tr> </thead> <tbody> <tr> <td>IP1385A1</td> <td>CORNER POLYSTYREN E PACKING 110X80X2000</td> <td>2.540</td> <td>M</td> </tr> <tr> <td>LP1029A0</td> <td>L=1199 S6 NO LED LIGHT BAR COVER</td> <td>1</td> <td>PZ</td> </tr> <tr> <td>VM1059A1</td> <td>HEAT SHRINK FILM H800</td> <td>2.540</td> <td>M</td> </tr> </tbody> </table>    | Code | Description | Qty | UOM | IP1385A1 | CORNER POLYSTYREN E PACKING 110X80X2000 | 2.540 | M  | LP1029A0 | L=1199 S6 NO LED LIGHT BAR COVER    | 1 | PZ | VM1059A1 | HEAT SHRINK FILM H800 | 2.540 | M |
| Code      | Description                             | Qty   | UOM        |  |  |      |             |     |     |          |   |       |    |          |                                     |   |    |          |                       |       |   |
| IP1385A1  | CORNER POLYSTYREN E PACKING 110X80X2000 | 2.540   | M          |  |  |      |             |     |     |          |   |       |    |          |                                     |   |    |          |                       |       |   |
| LP1029A0  | L=1199 S6 NO LED LIGHT BAR COVER        | 1   | PZ         |  |  |      |             |     |     |          |   |       |    |          |                                     |   |    |          |                       |       |   |
| VM1059A1  | HEAT SHRINK FILM H800                   | 2.540   | M          |  |  |      |             |     |     |          |   |       |    |          |                                     |   |    |          |                       |       |   |
| VM2339A   |   |  | VM2339A0   |  |  |      |             |     |     |          |   |       |    |          |                                     |   |    |          |                       |       |   |
| LP1023A   | 6 SERIES L800 LED LIGHT BAR - E1199     |  | KLP1023A   | L800 E1199 LED LIGHT BAR KIT             | <table border="1"> <thead> <tr> <th>Code</th> <th>Description</th> <th>Qty</th> <th>UOM</th> </tr> </thead> <tbody> <tr> <td>IP1385A1</td> <td>CORNER POLYSTYREN E PACKING 110X80X2000</td> <td>2.540</td> <td>M</td> </tr> <tr> <td>LP1023A0</td> <td>6 SERIES L800 LED LIGHT BAR - E1199</td> <td>1</td> <td>PZ</td> </tr> <tr> <td>VM1059A1</td> <td>HEAT SHRINK FILM H800</td> <td>2.540</td> <td>M</td> </tr> </tbody> </table> | Code | Description | Qty | UOM | IP1385A1 | CORNER POLYSTYREN E PACKING 110X80X2000 | 2.540 | M  | LP1023A0 | 6 SERIES L800 LED LIGHT BAR - E1199 | 1 | PZ | VM1059A1 | HEAT SHRINK FILM H800 | 2.540 | M |
| Code      | Description                             | Qty   | UOM        |  |  |      |             |     |     |          |   |       |    |          |                                     |   |    |          |                       |       |   |
| IP1385A1  | CORNER POLYSTYREN E PACKING 110X80X2000 | 2.540   | M          |  |  |      |             |     |     |          |   |       |    |          |                                     |   |    |          |                       |       |   |
| LP1023A0  | 6 SERIES L800 LED LIGHT BAR - E1199     | 1   | PZ         |  |  |      |             |     |     |          |   |       |    |          |                                     |   |    |          |                       |       |   |
| VM1059A1  | HEAT SHRINK FILM H800                   | 2.540   | M          |  |  |      |             |     |     |          |   |       |    |          |                                     |   |    |          |                       |       |   |

| COMPONENT |   |   | SPARE PART |   |   |      |             |     |     |          |   |   |    |          |   |   |    |          |   |   |    |
|-----------|---|---|------------|---|---|------|-------------|-----|-----|----------|---|---|----|----------|---|---|----|----------|---|---|----|
| Code      | Description                                   | Image   | Code       | Description                                   | Components list   |      |             |     |     |          |   |   |    |          |   |   |    |          |   |   |    |
| VM2339A   |   |    | VM2339A0   |   |   |      |             |     |     |          |   |   |    |          |   |   |    |          |   |   |    |
| VM2355A   | XEVC-2011<br>INTERNAL GLASS<br>LOCKING KIT    |    | KVM2355A   | XEVC-2011 INT.<br>GLASS LOCKING 2<br>PCS. KIT | <table border="1"> <thead> <tr> <th>Code</th> <th>Description</th> <th>Qty</th> <th>UOM</th> </tr> </thead> <tbody> <tr> <td>V11220A1</td> <td>4,2X12 TCB<br/>SELF-TAPPIN<br/>G SCREW</td> <td>4</td> <td>PZ</td> </tr> <tr> <td>VM2355A0</td> <td>XEVC-2011<br/>INTERNAL<br/>GLASS<br/>LOCKING KIT</td> <td>2</td> <td>PZ</td> </tr> <tr> <td>VM2355A0</td> <td>XEVC-2011<br/>INTERNAL<br/>GLASS<br/>LOCKING KIT</td> <td>2</td> <td>PZ</td> </tr> </tbody> </table> | Code | Description | Qty | UOM | V11220A1 | 4,2X12 TCB<br>SELF-TAPPIN<br>G SCREW    | 4 | PZ | VM2355A0 | XEVC-2011<br>INTERNAL<br>GLASS<br>LOCKING KIT | 2 | PZ | VM2355A0 | XEVC-2011<br>INTERNAL<br>GLASS<br>LOCKING KIT | 2 | PZ |
| Code      | Description                                   | Qty   | UOM        |   |   |      |             |     |     |          |   |   |    |          |   |   |    |          |   |   |    |
| V11220A1  | 4,2X12 TCB<br>SELF-TAPPIN<br>G SCREW          | 4   | PZ         |   |   |      |             |     |     |          |   |   |    |          |   |   |    |          |   |   |    |
| VM2355A0  | XEVC-2011<br>INTERNAL<br>GLASS<br>LOCKING KIT | 2   | PZ         |   |   |      |             |     |     |          |   |   |    |          |   |   |    |          |   |   |    |
| VM2355A0  | XEVC-2011<br>INTERNAL<br>GLASS<br>LOCKING KIT | 2   | PZ         |   |   |      |             |     |     |          |   |   |    |          |   |   |    |          |   |   |    |
| TB2911A   | XEVC-2011-E DOOR<br>BEAM                      |  |            |   |   |      |             |     |     |          |   |   |    |          |   |   |    |          |   |   |    |
| VM2410A   | PLATE TO STOP<br>EXTRUDED LED BAR             |  | KVM2410A   | PLATE TO STOP<br>EXTRUDED LED BAR<br>2P KIT   | <table border="1"> <thead> <tr> <th>Code</th> <th>Description</th> <th>Qty</th> <th>UOM</th> </tr> </thead> <tbody> <tr> <td>0B1190A0</td> <td>PLATE TO<br/>STOP<br/>EXTRUDED<br/>LED BAR</td> <td>2</td> <td>PZ</td> </tr> <tr> <td>VM2410A0</td> <td>PLATE TO<br/>STOP<br/>EXTRUDED<br/>LED BAR</td> <td>2</td> <td>PZ</td> </tr> <tr> <td>VM2410A0</td> <td>PLATE TO<br/>STOP<br/>EXTRUDED<br/>LED BAR</td> <td>2</td> <td>PZ</td> </tr> </tbody> </table>         | Code | Description | Qty | UOM | 0B1190A0 | PLATE TO<br>STOP<br>EXTRUDED<br>LED BAR | 2 | PZ | VM2410A0 | PLATE TO<br>STOP<br>EXTRUDED<br>LED BAR       | 2 | PZ | VM2410A0 | PLATE TO<br>STOP<br>EXTRUDED<br>LED BAR       | 2 | PZ |
| Code      | Description                                   | Qty   | UOM        |   |   |      |             |     |     |          |   |   |    |          |   |   |    |          |   |   |    |
| 0B1190A0  | PLATE TO<br>STOP<br>EXTRUDED<br>LED BAR       | 2   | PZ         |   |   |      |             |     |     |          |   |   |    |          |   |   |    |          |   |   |    |
| VM2410A0  | PLATE TO<br>STOP<br>EXTRUDED<br>LED BAR       | 2   | PZ         |   |   |      |             |     |     |          |   |   |    |          |   |   |    |          |   |   |    |
| VM2410A0  | PLATE TO<br>STOP<br>EXTRUDED<br>LED BAR       | 2   | PZ         |   |   |      |             |     |     |          |   |   |    |          |   |   |    |          |   |   |    |



| COMPONENT |                                     |   | SPARE PART |                                 |  |      |             |     |     |          |                               |   |    |          |                               |   |    |          |                                     |       |    |
|-----------|-------------------------------------|---|------------|---------------------------------|--|------|-------------|-----|-----|----------|-------------------------------|---|----|----------|-------------------------------|---|----|----------|-------------------------------------|-------|----|
| Code      | Description                         | Image   | Code       | Description                     | Components list  |      |             |     |     |          |                               |   |    |          |                               |   |    |          |                                     |       |    |
| PE2046A   | MM POWER SWITCH AND USB BOARD       |    | KPE2046A   | MIND.MAPS USB-RESET SUPPORT KIT | <table border="1"> <thead> <tr> <th>Code</th> <th>Description</th> <th>Qty</th> <th>UOM</th> </tr> </thead> <tbody> <tr> <td>PE2046A2</td> <td>MM POWER SWITCH AND USB BOARD</td> <td>1</td> <td>PZ</td> </tr> <tr> <td>VI1220A1</td> <td>4,2X12 TCB SELF-TAPPING SCREW</td> <td>2</td> <td>PZ</td> </tr> <tr> <td>VM2147A0</td> <td>ESD SPONGE PINK SMOOTH 410X343X15 M</td> <td>0.250</td> <td>PZ</td> </tr> </tbody> </table> | Code | Description | Qty | UOM | PE2046A2 | MM POWER SWITCH AND USB BOARD | 1 | PZ | VI1220A1 | 4,2X12 TCB SELF-TAPPING SCREW | 2 | PZ | VM2147A0 | ESD SPONGE PINK SMOOTH 410X343X15 M | 0.250 | PZ |
| Code      | Description                         | Qty   | UOM        |                                 |  |      |             |     |     |          |                               |   |    |          |                               |   |    |          |                                     |       |    |
| PE2046A2  | MM POWER SWITCH AND USB BOARD       | 1   | PZ         |                                 |  |      |             |     |     |          |                               |   |    |          |                               |   |    |          |                                     |       |    |
| VI1220A1  | 4,2X12 TCB SELF-TAPPING SCREW       | 2   | PZ         |                                 |  |      |             |     |     |          |                               |   |    |          |                               |   |    |          |                                     |       |    |
| VM2147A0  | ESD SPONGE PINK SMOOTH 410X343X15 M | 0.250   | PZ         |                                 |  |      |             |     |     |          |                               |   |    |          |                               |   |    |          |                                     |       |    |
| TB3204A   | XEVC-2011-E UPPER DOOR BEAM         |   | TB3204A0   | XEVC-2011-E UPPER DOOR BEAM     |  |      |             |     |     |          |                               |   |    |          |                               |   |    |          |                                     |       |    |
| TB3203A   |                                     |  |            |                                 |  |      |             |     |     |          |                               |   |    |          |                               |   |    |          |                                     |       |    |
| VM2437A   |                                     |  |            |                                 |  |      |             |     |     |          |                               |   |    |          |                               |   |    |          |                                     |       |    |
| 0H7778A   | XEVC-2011 RIGHT EXT DOOR COLUMN     |  | 0H7778A0   | XEVC-2011 RIGHT EXT DOOR COLUMN |  |      |             |     |     |          |                               |   |    |          |                               |   |    |          |                                     |       |    |



| COMPONENT |   |   | SPARE PART |                                       |   |      |             |     |     |          |                                       |   |    |          |                          |   |    |          |   |   |    |
|-----------|---|---|------------|---------------------------------------|---|------|-------------|-----|-----|----------|---------------------------------------|---|----|----------|--------------------------|---|----|----------|---|---|----|
| Code      | Description                               | Image   | Code       | Description                           | Components list   |      |             |     |     |          |                                       |   |    |          |                          |   |    |          |   |   |    |
| 0H7779A   | XEVC-2011 CT LEFT<br>EXT DOOR COLUMN      |    | 0H7779A0   | XEVC-2011 CT LEFT<br>EXT DOOR COLUMN  |   |      |             |     |     |          |                                       |   |    |          |                          |   |    |          |   |   |    |
| 0H7240A   | XEVC-2011 RIGHT<br>INT DOOR COLUMN        |    |            |                                       |   |      |             |     |     |          |                                       |   |    |          |                          |   |    |          |   |   |    |
| 0H7241A   | XEVC-2011 LEFT INT<br>DOOR COLUMN         |  |            |                                       |   |      |             |     |     |          |                                       |   |    |          |                          |   |    |          |   |   |    |
| PE2042A   | MM ONE VERSION<br>CONTROL BOARD           |  | KPE2042A   | MIND.MAPS ONE<br>CONTROL BOARD<br>KIT | <table border="1"> <thead> <tr> <th>Code</th> <th>Description</th> <th>Qty</th> <th>UOM</th> </tr> </thead> <tbody> <tr> <td>PE2042A4</td> <td>MM ONE<br/>VERSION<br/>CONTROL<br/>BOARD</td> <td>1</td> <td>PZ</td> </tr> <tr> <td>VI2000A0</td> <td>SCREW M4X22<br/>TCB+ INOX</td> <td>4</td> <td>PZ</td> </tr> <tr> <td>VM2147A0</td> <td>ESD SPONGE<br/>PINK SMOOTH<br/>410X343X15 M</td> <td>1</td> <td>PZ</td> </tr> </tbody> </table> | Code | Description | Qty | UOM | PE2042A4 | MM ONE<br>VERSION<br>CONTROL<br>BOARD | 1 | PZ | VI2000A0 | SCREW M4X22<br>TCB+ INOX | 4 | PZ | VM2147A0 | ESD SPONGE<br>PINK SMOOTH<br>410X343X15 M | 1 | PZ |
| Code      | Description                               | Qty   | UOM        |                                       |   |      |             |     |     |          |                                       |   |    |          |                          |   |    |          |   |   |    |
| PE2042A4  | MM ONE<br>VERSION<br>CONTROL<br>BOARD     | 1   | PZ         |                                       |   |      |             |     |     |          |                                       |   |    |          |                          |   |    |          |   |   |    |
| VI2000A0  | SCREW M4X22<br>TCB+ INOX                  | 4   | PZ         |                                       |   |      |             |     |     |          |                                       |   |    |          |                          |   |    |          |   |   |    |
| VM2147A0  | ESD SPONGE<br>PINK SMOOTH<br>410X343X15 M | 1   | PZ         |                                       |   |      |             |     |     |          |                                       |   |    |          |                          |   |    |          |   |   |    |



**ASM1800A/0.D02 - External cover**

**FRONT**

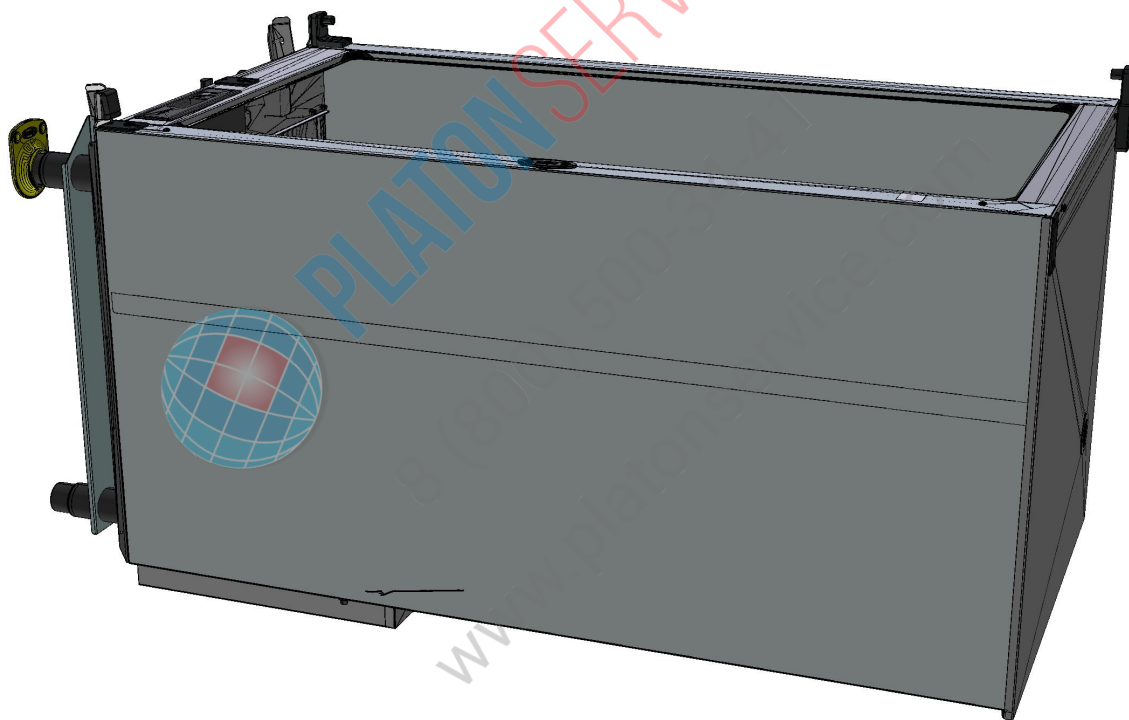

ASM1800A/0.D02 - External cover

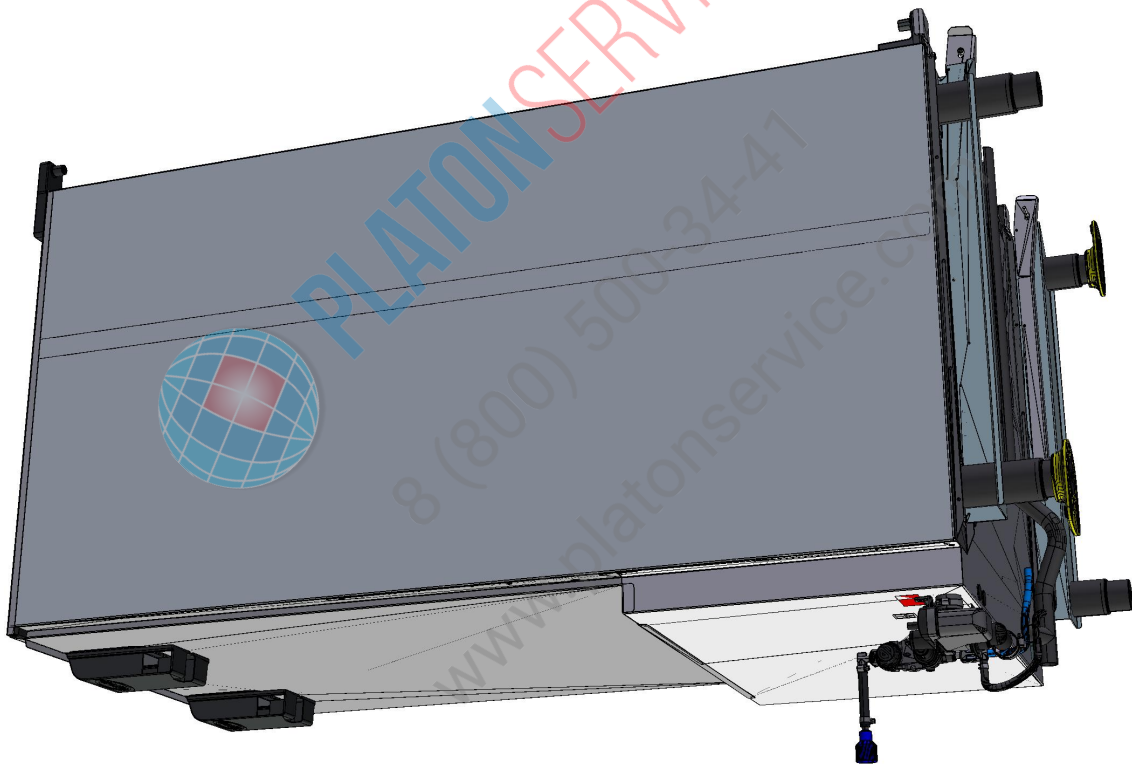

REAR



| COMPONENT |  |   | SPARE PART |                                      |   |      |             |     |     |          |                                    |   |    |          |                           |   |    |          |  |       |    |          |                                 |   |    |          |                       |   |    |          |                                 |   |    |          |                                |   |    |          |                                 |   |    |          |                            |   |    |          |                            |   |    |          |                       |   |    |          |                     |   |    |
|-----------|--|---|------------|--------------------------------------|---|------|-------------|-----|-----|----------|------------------------------------|---|----|----------|---------------------------|---|----|----------|--|-------|----|----------|---------------------------------|---|----|----------|-----------------------|---|----|----------|---------------------------------|---|----|----------|--------------------------------|---|----|----------|---------------------------------|---|----|----------|----------------------------|---|----|----------|----------------------------|---|----|----------|-----------------------|---|----|----------|---------------------|---|----|
| Code      | Description                            | Image   | Code       | Description                          | Components list   |      |             |     |     |          |                                    |   |    |          |                           |   |    |          |  |       |    |          |                                 |   |    |          |                       |   |    |          |                                 |   |    |          |                                |   |    |          |                                 |   |    |          |                            |   |    |          |                            |   |    |          |                       |   |    |          |                     |   |    |
| VM1750A   | BRASS COMB CLAM                        |    | KVM1750A   | COMB TERMINAL BLOCK KIT              | <table border="1"> <thead> <tr> <th>Code</th> <th>Description</th> <th>Qty</th> <th>UOM</th> </tr> </thead> <tbody> <tr> <td>VM1750A0</td> <td>BRASS COMB CLAMP</td> <td>1</td> <td>PZ</td> </tr> </tbody> </table>   | Code | Description | Qty | UOM | VM1750A0 | BRASS COMB CLAMP                   | 1 | PZ |          |                           |   |    |          |  |       |    |          |                                 |   |    |          |                       |   |    |          |                                 |   |    |          |                                |   |    |          |                                 |   |    |          |                            |   |    |          |                            |   |    |          |                       |   |    |          |                     |   |    |
| Code      | Description                            | Qty   | UOM        |                                      |   |      |             |     |     |          |                                    |   |    |          |                           |   |    |          |  |       |    |          |                                 |   |    |          |                       |   |    |          |                                 |   |    |          |                                |   |    |          |                                 |   |    |          |                            |   |    |          |                            |   |    |          |                       |   |    |          |                     |   |    |
| VM1750A0  | BRASS COMB CLAMP                       | 1   | PZ         |                                      |   |      |             |     |     |          |                                    |   |    |          |                           |   |    |          |  |       |    |          |                                 |   |    |          |                       |   |    |          |                                 |   |    |          |                                |   |    |          |                                 |   |    |          |                            |   |    |          |                            |   |    |          |                       |   |    |          |                     |   |    |
| RC1378A   | HOSE CLAMP                             |    | KVE1135A   | SERIES 5/5E VENTURI KIT              | <table border="1"> <thead> <tr> <th>Code</th> <th>Description</th> <th>Qty</th> <th>UOM</th> </tr> </thead> <tbody> <tr> <td>GN1556A0</td> <td>MM VENTURI SEAL</td> <td>1</td> <td>PZ</td> </tr> <tr> <td>RC1378A0</td> <td>HOSE CLAMP</td> <td>2</td> <td>PZ</td> </tr> <tr> <td>TB1520A0</td> <td>INT. Ø=38 TH=4 DRAIN BLACK RUBBER PIPE</td> <td>0.050</td> <td>M</td> </tr> <tr> <td>VE1135A0</td> <td>220 V 50/60 HZ VENTURI ACTUATOR</td> <td>1</td> <td>PZ</td> </tr> <tr> <td>V11032A0</td> <td>SCREW M4X16 TCB+ INOX</td> <td>1</td> <td>PZ</td> </tr> <tr> <td>V11511A0</td> <td>STAINLESS STEEL WASHER 4.2X12X1</td> <td>2</td> <td>PZ</td> </tr> <tr> <td>V11850A0</td> <td>M4X6 NICKEL PLATED FIXING SCRE</td> <td>2</td> <td>PZ</td> </tr> <tr> <td>V11865A0</td> <td>5X10 TCB+ SELF-THREADI NG SCREW</td> <td>3</td> <td>PZ</td> </tr> <tr> <td>VM1565B0</td> <td>VENTURI LOWER COIL SUPPORT</td> <td>1</td> <td>PZ</td> </tr> <tr> <td>VM1566A0</td> <td>VENTURI UPPER COIL SUPPORT</td> <td>1</td> <td>PZ</td> </tr> <tr> <td>VM1567A0</td> <td>VENTURI LOWER BUSHING</td> <td>1</td> <td>PZ</td> </tr> <tr> <td>VM1568A0</td> <td>VENTURI PLATE SPACE</td> <td>1</td> <td>PZ</td> </tr> </tbody> </table> | Code | Description | Qty | UOM | GN1556A0 | MM VENTURI SEAL                    | 1 | PZ | RC1378A0 | HOSE CLAMP                | 2 | PZ | TB1520A0 | INT. Ø=38 TH=4 DRAIN BLACK RUBBER PIPE | 0.050 | M  | VE1135A0 | 220 V 50/60 HZ VENTURI ACTUATOR | 1 | PZ | V11032A0 | SCREW M4X16 TCB+ INOX | 1 | PZ | V11511A0 | STAINLESS STEEL WASHER 4.2X12X1 | 2 | PZ | V11850A0 | M4X6 NICKEL PLATED FIXING SCRE | 2 | PZ | V11865A0 | 5X10 TCB+ SELF-THREADI NG SCREW | 3 | PZ | VM1565B0 | VENTURI LOWER COIL SUPPORT | 1 | PZ | VM1566A0 | VENTURI UPPER COIL SUPPORT | 1 | PZ | VM1567A0 | VENTURI LOWER BUSHING | 1 | PZ | VM1568A0 | VENTURI PLATE SPACE | 1 | PZ |
| Code      | Description                            | Qty   | UOM        |                                      |   |      |             |     |     |          |                                    |   |    |          |                           |   |    |          |  |       |    |          |                                 |   |    |          |                       |   |    |          |                                 |   |    |          |                                |   |    |          |                                 |   |    |          |                            |   |    |          |                            |   |    |          |                       |   |    |          |                     |   |    |
| GN1556A0  | MM VENTURI SEAL                        | 1   | PZ         |                                      |   |      |             |     |     |          |                                    |   |    |          |                           |   |    |          |  |       |    |          |                                 |   |    |          |                       |   |    |          |                                 |   |    |          |                                |   |    |          |                                 |   |    |          |                            |   |    |          |                            |   |    |          |                       |   |    |          |                     |   |    |
| RC1378A0  | HOSE CLAMP                             | 2   | PZ         |                                      |   |      |             |     |     |          |                                    |   |    |          |                           |   |    |          |  |       |    |          |                                 |   |    |          |                       |   |    |          |                                 |   |    |          |                                |   |    |          |                                 |   |    |          |                            |   |    |          |                            |   |    |          |                       |   |    |          |                     |   |    |
| TB1520A0  | INT. Ø=38 TH=4 DRAIN BLACK RUBBER PIPE | 0.050   | M          |                                      |   |      |             |     |     |          |                                    |   |    |          |                           |   |    |          |  |       |    |          |                                 |   |    |          |                       |   |    |          |                                 |   |    |          |                                |   |    |          |                                 |   |    |          |                            |   |    |          |                            |   |    |          |                       |   |    |          |                     |   |    |
| VE1135A0  | 220 V 50/60 HZ VENTURI ACTUATOR        | 1   | PZ         |                                      |   |      |             |     |     |          |                                    |   |    |          |                           |   |    |          |  |       |    |          |                                 |   |    |          |                       |   |    |          |                                 |   |    |          |                                |   |    |          |                                 |   |    |          |                            |   |    |          |                            |   |    |          |                       |   |    |          |                     |   |    |
| V11032A0  | SCREW M4X16 TCB+ INOX                  | 1   | PZ         |                                      |   |      |             |     |     |          |                                    |   |    |          |                           |   |    |          |  |       |    |          |                                 |   |    |          |                       |   |    |          |                                 |   |    |          |                                |   |    |          |                                 |   |    |          |                            |   |    |          |                            |   |    |          |                       |   |    |          |                     |   |    |
| V11511A0  | STAINLESS STEEL WASHER 4.2X12X1        | 2   | PZ         |                                      |   |      |             |     |     |          |                                    |   |    |          |                           |   |    |          |  |       |    |          |                                 |   |    |          |                       |   |    |          |                                 |   |    |          |                                |   |    |          |                                 |   |    |          |                            |   |    |          |                            |   |    |          |                       |   |    |          |                     |   |    |
| V11850A0  | M4X6 NICKEL PLATED FIXING SCRE         | 2   | PZ         |                                      |   |      |             |     |     |          |                                    |   |    |          |                           |   |    |          |  |       |    |          |                                 |   |    |          |                       |   |    |          |                                 |   |    |          |                                |   |    |          |                                 |   |    |          |                            |   |    |          |                            |   |    |          |                       |   |    |          |                     |   |    |
| V11865A0  | 5X10 TCB+ SELF-THREADI NG SCREW        | 3   | PZ         |                                      |   |      |             |     |     |          |                                    |   |    |          |                           |   |    |          |  |       |    |          |                                 |   |    |          |                       |   |    |          |                                 |   |    |          |                                |   |    |          |                                 |   |    |          |                            |   |    |          |                            |   |    |          |                       |   |    |          |                     |   |    |
| VM1565B0  | VENTURI LOWER COIL SUPPORT             | 1   | PZ         |                                      |   |      |             |     |     |          |                                    |   |    |          |                           |   |    |          |  |       |    |          |                                 |   |    |          |                       |   |    |          |                                 |   |    |          |                                |   |    |          |                                 |   |    |          |                            |   |    |          |                            |   |    |          |                       |   |    |          |                     |   |    |
| VM1566A0  | VENTURI UPPER COIL SUPPORT             | 1   | PZ         |                                      |   |      |             |     |     |          |                                    |   |    |          |                           |   |    |          |  |       |    |          |                                 |   |    |          |                       |   |    |          |                                 |   |    |          |                                |   |    |          |                                 |   |    |          |                            |   |    |          |                            |   |    |          |                       |   |    |          |                     |   |    |
| VM1567A0  | VENTURI LOWER BUSHING                  | 1   | PZ         |                                      |   |      |             |     |     |          |                                    |   |    |          |                           |   |    |          |  |       |    |          |                                 |   |    |          |                       |   |    |          |                                 |   |    |          |                                |   |    |          |                                 |   |    |          |                            |   |    |          |                            |   |    |          |                       |   |    |          |                     |   |    |
| VM1568A0  | VENTURI PLATE SPACE                    | 1   | PZ         |                                      |   |      |             |     |     |          |                                    |   |    |          |                           |   |    |          |  |       |    |          |                                 |   |    |          |                       |   |    |          |                                 |   |    |          |                                |   |    |          |                                 |   |    |          |                            |   |    |          |                            |   |    |          |                       |   |    |          |                     |   |    |
| VN1165A   | 230VAC 50/60HZ COOLING DOWN FA         |  | KVN1165A   | S.5E ADVANCE/MM 230V COOLING FAN KIT | <table border="1"> <thead> <tr> <th>Code</th> <th>Description</th> <th>Qty</th> <th>UOM</th> </tr> </thead> <tbody> <tr> <td>V11099A0</td> <td>SELF-DRILLIN G SCREW 4.8X13 TCB+ Z</td> <td>4</td> <td>PZ</td> </tr> <tr> <td>VM1555A2</td> <td>CT BT COOLING FAN SUPPORT</td> <td>1</td> <td>PZ</td> </tr> <tr> <td>VN1165A0</td> <td>230VAC 50/60HZ COOLING DOWN FAN</td> <td>1</td> <td>PZ</td> </tr> <tr> <td>VN1165A0</td> <td>230VAC 50/60HZ COOLING DOWN FAN</td> <td>1</td> <td>PZ</td> </tr> </tbody> </table>  | Code | Description | Qty | UOM | V11099A0 | SELF-DRILLIN G SCREW 4.8X13 TCB+ Z | 4 | PZ | VM1555A2 | CT BT COOLING FAN SUPPORT | 1 | PZ | VN1165A0 | 230VAC 50/60HZ COOLING DOWN FAN        | 1     | PZ | VN1165A0 | 230VAC 50/60HZ COOLING DOWN FAN | 1 | PZ |          |                       |   |    |          |                                 |   |    |          |                                |   |    |          |                                 |   |    |          |                            |   |    |          |                            |   |    |          |                       |   |    |          |                     |   |    |
| Code      | Description                            | Qty   | UOM        |                                      |   |      |             |     |     |          |                                    |   |    |          |                           |   |    |          |  |       |    |          |                                 |   |    |          |                       |   |    |          |                                 |   |    |          |                                |   |    |          |                                 |   |    |          |                            |   |    |          |                            |   |    |          |                       |   |    |          |                     |   |    |
| V11099A0  | SELF-DRILLIN G SCREW 4.8X13 TCB+ Z     | 4   | PZ         |                                      |   |      |             |     |     |          |                                    |   |    |          |                           |   |    |          |  |       |    |          |                                 |   |    |          |                       |   |    |          |                                 |   |    |          |                                |   |    |          |                                 |   |    |          |                            |   |    |          |                            |   |    |          |                       |   |    |          |                     |   |    |
| VM1555A2  | CT BT COOLING FAN SUPPORT              | 1   | PZ         |                                      |   |      |             |     |     |          |                                    |   |    |          |                           |   |    |          |  |       |    |          |                                 |   |    |          |                       |   |    |          |                                 |   |    |          |                                |   |    |          |                                 |   |    |          |                            |   |    |          |                            |   |    |          |                       |   |    |          |                     |   |    |
| VN1165A0  | 230VAC 50/60HZ COOLING DOWN FAN        | 1   | PZ         |                                      |   |      |             |     |     |          |                                    |   |    |          |                           |   |    |          |  |       |    |          |                                 |   |    |          |                       |   |    |          |                                 |   |    |          |                                |   |    |          |                                 |   |    |          |                            |   |    |          |                            |   |    |          |                       |   |    |          |                     |   |    |
| VN1165A0  | 230VAC 50/60HZ COOLING DOWN FAN        | 1   | PZ         |                                      |   |      |             |     |     |          |                                    |   |    |          |                           |   |    |          |  |       |    |          |                                 |   |    |          |                       |   |    |          |                                 |   |    |          |                                |   |    |          |                                 |   |    |          |                            |   |    |          |                            |   |    |          |                       |   |    |          |                     |   |    |



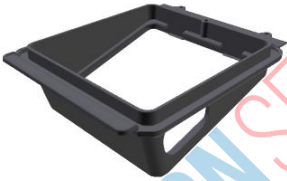





| COMPONENT |                                    |   | SPARE PART |                                      |  |      |             |     |     |          |                                    |   |    |          |                           |   |    |          |                                 |   |    |          |                                 |   |    |
|-----------|------------------------------------|---|------------|--------------------------------------|--|------|-------------|-----|-----|----------|------------------------------------|---|----|----------|---------------------------|---|----|----------|---------------------------------|---|----|----------|---------------------------------|---|----|
| Code      | Description                        | Image   | Code       | Description                          | Components list  |      |             |     |     |          |                                    |   |    |          |                           |   |    |          |                                 |   |    |          |                                 |   |    |
| VM1556A   | XBC-XVC COOLING FAN GUARD          |    | KVM1556A   | XBC-XVC COOLING FAN GUARD KIT        | <table border="1"> <thead> <tr> <th>Code</th> <th>Description</th> <th>Qty</th> <th>UOM</th> </tr> </thead> <tbody> <tr> <td>VM1556A0</td> <td>XBC-XVC COOLING FAN GUARD</td> <td>1</td> <td>PZ</td> </tr> </tbody> </table>   | Code | Description | Qty | UOM | VM1556A0 | XBC-XVC COOLING FAN GUARD          | 1 | PZ |          |                           |   |    |          |                                 |   |    |          |                                 |   |    |
| Code      | Description                        | Qty   | UOM        |                                      |  |      |             |     |     |          |                                    |   |    |          |                           |   |    |          |                                 |   |    |          |                                 |   |    |
| VM1556A0  | XBC-XVC COOLING FAN GUARD          | 1   | PZ         |                                      |  |      |             |     |     |          |                                    |   |    |          |                           |   |    |          |                                 |   |    |          |                                 |   |    |
| VM1555A   | CT BT COOLING FAN SUPPORT          |    | KVN1165A   | S.5E ADVANCE/MM 230V COOLING FAN KIT | <table border="1"> <thead> <tr> <th>Code</th> <th>Description</th> <th>Qty</th> <th>UOM</th> </tr> </thead> <tbody> <tr> <td>VI1099A0</td> <td>SELF-DRILLIN G SCREW 4.8X13 TCB+ Z</td> <td>4</td> <td>PZ</td> </tr> <tr> <td>VM1555A2</td> <td>CT BT COOLING FAN SUPPORT</td> <td>1</td> <td>PZ</td> </tr> <tr> <td>VN1165A0</td> <td>230VAC 50/60HZ COOLING DOWN FAN</td> <td>1</td> <td>PZ</td> </tr> <tr> <td>VN1165A0</td> <td>230VAC 50/60HZ COOLING DOWN FAN</td> <td>1</td> <td>PZ</td> </tr> </tbody> </table> | Code | Description | Qty | UOM | VI1099A0 | SELF-DRILLIN G SCREW 4.8X13 TCB+ Z | 4 | PZ | VM1555A2 | CT BT COOLING FAN SUPPORT | 1 | PZ | VN1165A0 | 230VAC 50/60HZ COOLING DOWN FAN | 1 | PZ | VN1165A0 | 230VAC 50/60HZ COOLING DOWN FAN | 1 | PZ |
| Code      | Description                        | Qty   | UOM        |                                      |  |      |             |     |     |          |                                    |   |    |          |                           |   |    |          |                                 |   |    |          |                                 |   |    |
| VI1099A0  | SELF-DRILLIN G SCREW 4.8X13 TCB+ Z | 4   | PZ         |                                      |  |      |             |     |     |          |                                    |   |    |          |                           |   |    |          |                                 |   |    |          |                                 |   |    |
| VM1555A2  | CT BT COOLING FAN SUPPORT          | 1   | PZ         |                                      |  |      |             |     |     |          |                                    |   |    |          |                           |   |    |          |                                 |   |    |          |                                 |   |    |
| VN1165A0  | 230VAC 50/60HZ COOLING DOWN FAN    | 1   | PZ         |                                      |  |      |             |     |     |          |                                    |   |    |          |                           |   |    |          |                                 |   |    |          |                                 |   |    |
| VN1165A0  | 230VAC 50/60HZ COOLING DOWN FAN    | 1   | PZ         |                                      |  |      |             |     |     |          |                                    |   |    |          |                           |   |    |          |                                 |   |    |          |                                 |   |    |
|           |                                    |   | KVN1164A   | S.5/5E 12VDC COOLING DOWN FAN KIT    | <table border="1"> <thead> <tr> <th>Code</th> <th>Description</th> <th>Qty</th> <th>UOM</th> </tr> </thead> <tbody> <tr> <td>VI1099A0</td> <td>SELF-DRILLIN G SCREW 4.8X13 TCB+ Z</td> <td>4</td> <td>PZ</td> </tr> <tr> <td>VM1555A2</td> <td>CT BT COOLING FAN SUPPORT</td> <td>1</td> <td>PZ</td> </tr> <tr> <td>VN1164A0</td> <td>12VDC COOLING DONW FAN</td> <td>1</td> <td>PZ</td> </tr> <tr> <td>VN1164A0</td> <td>12VDC COOLING DONW FAN</td> <td>1</td> <td>PZ</td> </tr> </tbody> </table>                   | Code | Description | Qty | UOM | VI1099A0 | SELF-DRILLIN G SCREW 4.8X13 TCB+ Z | 4 | PZ | VM1555A2 | CT BT COOLING FAN SUPPORT | 1 | PZ | VN1164A0 | 12VDC COOLING DONW FAN          | 1 | PZ | VN1164A0 | 12VDC COOLING DONW FAN          | 1 | PZ |
| Code      | Description                        | Qty   | UOM        |                                      |  |      |             |     |     |          |                                    |   |    |          |                           |   |    |          |                                 |   |    |          |                                 |   |    |
| VI1099A0  | SELF-DRILLIN G SCREW 4.8X13 TCB+ Z | 4   | PZ         |                                      |  |      |             |     |     |          |                                    |   |    |          |                           |   |    |          |                                 |   |    |          |                                 |   |    |
| VM1555A2  | CT BT COOLING FAN SUPPORT          | 1   | PZ         |                                      |  |      |             |     |     |          |                                    |   |    |          |                           |   |    |          |                                 |   |    |          |                                 |   |    |
| VN1164A0  | 12VDC COOLING DONW FAN             | 1   | PZ         |                                      |  |      |             |     |     |          |                                    |   |    |          |                           |   |    |          |                                 |   |    |          |                                 |   |    |
| VN1164A0  | 12VDC COOLING DONW FAN             | 1   | PZ         |                                      |  |      |             |     |     |          |                                    |   |    |          |                           |   |    |          |                                 |   |    |          |                                 |   |    |
| GN1558A   | EXHAUST SEAL                       |  | K0H7291A   | GASKET AND SEALING DISC CHIMNEY KIT  | <table border="1"> <thead> <tr> <th>Code</th> <th>Description</th> <th>Qty</th> <th>UOM</th> </tr> </thead> <tbody> <tr> <td>0H7291A0</td> <td>CHIMNEY HOLDING DIS</td> <td>1</td> <td>PZ</td> </tr> <tr> <td>GN1558A0</td> <td>EXHAUST SEA</td> <td>1</td> <td>PZ</td> </tr> </tbody> </table>  | Code | Description | Qty | UOM | 0H7291A0 | CHIMNEY HOLDING DIS                | 1 | PZ | GN1558A0 | EXHAUST SEA               | 1 | PZ |          |                                 |   |    |          |                                 |   |    |
| Code      | Description                        | Qty   | UOM        |                                      |  |      |             |     |     |          |                                    |   |    |          |                           |   |    |          |                                 |   |    |          |                                 |   |    |
| 0H7291A0  | CHIMNEY HOLDING DIS                | 1   | PZ         |                                      |  |      |             |     |     |          |                                    |   |    |          |                           |   |    |          |                                 |   |    |          |                                 |   |    |
| GN1558A0  | EXHAUST SEA                        | 1   | PZ         |                                      |  |      |             |     |     |          |                                    |   |    |          |                           |   |    |          |                                 |   |    |          |                                 |   |    |



| COMPONENT |                                      |   | SPARE PART |                                       |  |      |             |     |     |          |                                      |    |    |          |             |   |    |
|-----------|--------------------------------------|---|------------|---------------------------------------|--|------|-------------|-----|-----|----------|--------------------------------------|----|----|----------|-------------|---|----|
| Code      | Description                          | Image   | Code       | Description                           | Components list  |      |             |     |     |          |                                      |    |    |          |             |   |    |
| 0H7291A   | CHIMNEY HOLDING DISC                 |    | K0H7291A   | GASKET AND SEALING DISC CHIMNEY KIT   | <table border="1"> <thead> <tr> <th>Code</th> <th>Description</th> <th>Qty</th> <th>UOM</th> </tr> </thead> <tbody> <tr> <td>0H7291A0</td> <td>CHIMNEY HOLDING DISC</td> <td>1</td> <td>PZ</td> </tr> <tr> <td>GN1558A0</td> <td>EXHAUST SEA</td> <td>1</td> <td>PZ</td> </tr> </tbody> </table> | Code | Description | Qty | UOM | 0H7291A0 | CHIMNEY HOLDING DISC                 | 1  | PZ | GN1558A0 | EXHAUST SEA | 1 | PZ |
| Code      | Description                          | Qty   | UOM        |                                       |  |      |             |     |     |          |                                      |    |    |          |             |   |    |
| 0H7291A0  | CHIMNEY HOLDING DISC                 | 1   | PZ         |                                       |  |      |             |     |     |          |                                      |    |    |          |             |   |    |
| GN1558A0  | EXHAUST SEA                          | 1   | PZ         |                                       |  |      |             |     |     |          |                                      |    |    |          |             |   |    |
| 0H2561A   | 6 S. DOOR COUNTERBRACKET             |    | 0H2561A0   | 6 S. DOOR COUNTERBRACKET              |  |      |             |     |     |          |                                      |    |    |          |             |   |    |
| RC1055A   | Ø25-40 H12 STAINLESS STEEL PIPE CLIP |  | KRC1055A   | Ø25-40 PIPE CLAMP 10PCS KIT           | <table border="1"> <thead> <tr> <th>Code</th> <th>Description</th> <th>Qty</th> <th>UOM</th> </tr> </thead> <tbody> <tr> <td>RC1055A0</td> <td>Ø25-40 H12 STAINLESS STEEL PIPE CLIP</td> <td>10</td> <td>PZ</td> </tr> </tbody> </table>   | Code | Description | Qty | UOM | RC1055A0 | Ø25-40 H12 STAINLESS STEEL PIPE CLIP | 10 | PZ |          |             |   |    |
| Code      | Description                          | Qty   | UOM        |                                       |  |      |             |     |     |          |                                      |    |    |          |             |   |    |
| RC1055A0  | Ø25-40 H12 STAINLESS STEEL PIPE CLIP | 10  | PZ         |                                       |  |      |             |     |     |          |                                      |    |    |          |             |   |    |
| 0F1506A   | XEVC-2011 EXTERNAL UPPER BACK PANEL  |  | 0F1506A0   | XEVC-2011 EXTERNAL UPPER BACK PANEL   |  |      |             |     |     |          |                                      |    |    |          |             |   |    |
| PD1078A   | 2FT ADJUSTABLE FOOT H147-190 PLATE   |  | KPD1078A   | 2" H147-190 ADJUSTABLE FEET 4 PCS KIT | <table border="1"> <thead> <tr> <th>Code</th> <th>Description</th> <th>Qty</th> <th>UOM</th> </tr> </thead> <tbody> <tr> <td>PD1078A0</td> <td>2FT ADJUSTABLE FOOT H147-190 PLATE</td> <td>4</td> <td>PZ</td> </tr> </tbody> </table>  | Code | Description | Qty | UOM | PD1078A0 | 2FT ADJUSTABLE FOOT H147-190 PLATE   | 4  | PZ |          |             |   |    |
| Code      | Description                          | Qty   | UOM        |                                       |  |      |             |     |     |          |                                      |    |    |          |             |   |    |
| PD1078A0  | 2FT ADJUSTABLE FOOT H147-190 PLATE   | 4   | PZ         |                                       |  |      |             |     |     |          |                                      |    |    |          |             |   |    |

| COMPONENT |                                      |   | SPARE PART |  |  |             |             |     |     |          |                                      |   |    |          |                                |   |    |          |                               |   |    |          |                                    |   |    |          |                              |   |    |
|-----------|--------------------------------------|---|------------|--|--|-------------|-------------|-----|-----|----------|--------------------------------------|---|----|----------|--------------------------------|---|----|----------|-------------------------------|---|----|----------|------------------------------------|---|----|----------|------------------------------|---|----|
| Code      | Description                          | Image   | Code       | Description                            | Components list  |             |             |     |     |          |                                      |   |    |          |                                |   |    |          |                               |   |    |          |                                    |   |    |          |                              |   |    |
| VM1190A   | CT BT RIGHT DOOR SPRING LATCH        |    | KVM1190A   | CHEFTOP/BAKERTO P DOOR RIGHT LATCH KIT | <table border="1"> <thead> <tr> <th>Code</th> <th>Description</th> <th>Qty</th> <th>UOM</th> </tr> </thead> <tbody> <tr> <td>VI0239A1</td> <td>SELF-TAPPIN G SCREW 4.2X25 TCB+ INOX</td> <td>2</td> <td>PZ</td> </tr> <tr> <td>VI1220A1</td> <td>4,2X12 TCB SELF-TAPPIN G SCREW</td> <td>2</td> <td>PZ</td> </tr> <tr> <td>VM1190A2</td> <td>CT BT RIGHT DOOR SPRING LATCH</td> <td>1</td> <td>PZ</td> </tr> <tr> <td>VM1192A1</td> <td>CT BT DOOR SPRING LATCH BACK COVER</td> <td>1</td> <td>PZ</td> </tr> <tr> <td>VM1460A0</td> <td>XBC/XVC RIGHT DOOR LATCH CAP</td> <td>1</td> <td>PZ</td> </tr> </tbody> </table> | Code        | Description | Qty | UOM | VI0239A1 | SELF-TAPPIN G SCREW 4.2X25 TCB+ INOX | 2 | PZ | VI1220A1 | 4,2X12 TCB SELF-TAPPIN G SCREW | 2 | PZ | VM1190A2 | CT BT RIGHT DOOR SPRING LATCH | 1 | PZ | VM1192A1 | CT BT DOOR SPRING LATCH BACK COVER | 1 | PZ | VM1460A0 | XBC/XVC RIGHT DOOR LATCH CAP | 1 | PZ |
|           |                                      |   |            |  | Code   | Description | Qty         | UOM |     |          |                                      |   |    |          |                                |   |    |          |                               |   |    |          |                                    |   |    |          |                              |   |    |
| VI0239A1  | SELF-TAPPIN G SCREW 4.2X25 TCB+ INOX | 2   | PZ         |  |  |             |             |     |     |          |                                      |   |    |          |                                |   |    |          |                               |   |    |          |                                    |   |    |          |                              |   |    |
| VI1220A1  | 4,2X12 TCB SELF-TAPPIN G SCREW       | 2   | PZ         |  |  |             |             |     |     |          |                                      |   |    |          |                                |   |    |          |                               |   |    |          |                                    |   |    |          |                              |   |    |
| VM1190A2  | CT BT RIGHT DOOR SPRING LATCH        | 1   | PZ         |  |  |             |             |     |     |          |                                      |   |    |          |                                |   |    |          |                               |   |    |          |                                    |   |    |          |                              |   |    |
| VM1192A1  | CT BT DOOR SPRING LATCH BACK COVER   | 1   | PZ         |  |  |             |             |     |     |          |                                      |   |    |          |                                |   |    |          |                               |   |    |          |                                    |   |    |          |                              |   |    |
| VM1460A0  | XBC/XVC RIGHT DOOR LATCH CAP         | 1   | PZ         |  |  |             |             |     |     |          |                                      |   |    |          |                                |   |    |          |                               |   |    |          |                                    |   |    |          |                              |   |    |
| VM1192A   | CT BT DOOR SPRING LATCH BACK COVER   |  | KVM1191A   | CHEFTOP/BAKERTO P DOOR LEFT LATCH KIT  | <table border="1"> <thead> <tr> <th>Code</th> <th>Description</th> <th>Qty</th> <th>UOM</th> </tr> </thead> <tbody> <tr> <td>VI0239A1</td> <td>SELF-TAPPIN G SCREW 4.2X25 TCB+ INOX</td> <td>2</td> <td>PZ</td> </tr> <tr> <td>VI1220A1</td> <td>4,2X12 TCB SELF-TAPPIN G SCREW</td> <td>2</td> <td>PZ</td> </tr> <tr> <td>VM1191A2</td> <td>CT BT LEFT DOOR SPRING LATCH</td> <td>1</td> <td>PZ</td> </tr> <tr> <td>VM1192A1</td> <td>CT BT DOOR SPRING LATCH BACK COVER</td> <td>1</td> <td>PZ</td> </tr> <tr> <td>VM1460A0</td> <td>XBC/XVC RIGHT DOOR LATCH CAP</td> <td>1</td> <td>PZ</td> </tr> </tbody> </table>  | Code        | Description | Qty | UOM | VI0239A1 | SELF-TAPPIN G SCREW 4.2X25 TCB+ INOX | 2 | PZ | VI1220A1 | 4,2X12 TCB SELF-TAPPIN G SCREW | 2 | PZ | VM1191A2 | CT BT LEFT DOOR SPRING LATCH  | 1 | PZ | VM1192A1 | CT BT DOOR SPRING LATCH BACK COVER | 1 | PZ | VM1460A0 | XBC/XVC RIGHT DOOR LATCH CAP | 1 | PZ |
| Code      | Description                          | Qty   | UOM        |  |  |             |             |     |     |          |                                      |   |    |          |                                |   |    |          |                               |   |    |          |                                    |   |    |          |                              |   |    |
| VI0239A1  | SELF-TAPPIN G SCREW 4.2X25 TCB+ INOX | 2   | PZ         |  |  |             |             |     |     |          |                                      |   |    |          |                                |   |    |          |                               |   |    |          |                                    |   |    |          |                              |   |    |
| VI1220A1  | 4,2X12 TCB SELF-TAPPIN G SCREW       | 2   | PZ         |  |  |             |             |     |     |          |                                      |   |    |          |                                |   |    |          |                               |   |    |          |                                    |   |    |          |                              |   |    |
| VM1191A2  | CT BT LEFT DOOR SPRING LATCH         | 1   | PZ         |  |  |             |             |     |     |          |                                      |   |    |          |                                |   |    |          |                               |   |    |          |                                    |   |    |          |                              |   |    |
| VM1192A1  | CT BT DOOR SPRING LATCH BACK COVER   | 1   | PZ         |  |  |             |             |     |     |          |                                      |   |    |          |                                |   |    |          |                               |   |    |          |                                    |   |    |          |                              |   |    |
| VM1460A0  | XBC/XVC RIGHT DOOR LATCH CAP         | 1   | PZ         |  |  |             |             |     |     |          |                                      |   |    |          |                                |   |    |          |                               |   |    |          |                                    |   |    |          |                              |   |    |
|           |                                      |   | KVM1190A   | CHEFTOP/BAKERTO P DOOR RIGHT LATCH KIT | <table border="1"> <thead> <tr> <th>Code</th> <th>Description</th> <th>Qty</th> <th>UOM</th> </tr> </thead> <tbody> <tr> <td>VI0239A1</td> <td>SELF-TAPPIN G SCREW 4.2X25 TCB+ INOX</td> <td>2</td> <td>PZ</td> </tr> <tr> <td>VI1220A1</td> <td>4,2X12 TCB SELF-TAPPIN G SCREW</td> <td>2</td> <td>PZ</td> </tr> <tr> <td>VM1190A2</td> <td>CT BT RIGHT DOOR SPRING LATCH</td> <td>1</td> <td>PZ</td> </tr> <tr> <td>VM1192A1</td> <td>CT BT DOOR SPRING LATCH BACK COVER</td> <td>1</td> <td>PZ</td> </tr> <tr> <td>VM1460A0</td> <td>XBC/XVC RIGHT DOOR LATCH CAP</td> <td>1</td> <td>PZ</td> </tr> </tbody> </table> | Code        | Description | Qty | UOM | VI0239A1 | SELF-TAPPIN G SCREW 4.2X25 TCB+ INOX | 2 | PZ | VI1220A1 | 4,2X12 TCB SELF-TAPPIN G SCREW | 2 | PZ | VM1190A2 | CT BT RIGHT DOOR SPRING LATCH | 1 | PZ | VM1192A1 | CT BT DOOR SPRING LATCH BACK COVER | 1 | PZ | VM1460A0 | XBC/XVC RIGHT DOOR LATCH CAP | 1 | PZ |
| Code      | Description                          | Qty   | UOM        |  |  |             |             |     |     |          |                                      |   |    |          |                                |   |    |          |                               |   |    |          |                                    |   |    |          |                              |   |    |
| VI0239A1  | SELF-TAPPIN G SCREW 4.2X25 TCB+ INOX | 2   | PZ         |  |  |             |             |     |     |          |                                      |   |    |          |                                |   |    |          |                               |   |    |          |                                    |   |    |          |                              |   |    |
| VI1220A1  | 4,2X12 TCB SELF-TAPPIN G SCREW       | 2   | PZ         |  |  |             |             |     |     |          |                                      |   |    |          |                                |   |    |          |                               |   |    |          |                                    |   |    |          |                              |   |    |
| VM1190A2  | CT BT RIGHT DOOR SPRING LATCH        | 1   | PZ         |  |  |             |             |     |     |          |                                      |   |    |          |                                |   |    |          |                               |   |    |          |                                    |   |    |          |                              |   |    |
| VM1192A1  | CT BT DOOR SPRING LATCH BACK COVER   | 1   | PZ         |  |  |             |             |     |     |          |                                      |   |    |          |                                |   |    |          |                               |   |    |          |                                    |   |    |          |                              |   |    |
| VM1460A0  | XBC/XVC RIGHT DOOR LATCH CAP         | 1   | PZ         |  |  |             |             |     |     |          |                                      |   |    |          |                                |   |    |          |                               |   |    |          |                                    |   |    |          |                              |   |    |

| COMPONENT |   |   | SPARE PART |                                   |   |      |             |     |     |          |                      |   |    |          |                        |   |    |          |                     |       |    |          |                                      |   |    |          |  |       |   |          |                                |   |    |          |                                      |   |    |          |                          |   |    |          |   |   |    |          |             |   |    |          |              |   |    |          |                                  |   |    |
|-----------|---|---|------------|-----------------------------------|---|------|-------------|-----|-----|----------|----------------------|---|----|----------|------------------------|---|----|----------|---------------------|-------|----|----------|--------------------------------------|---|----|----------|--|-------|---|----------|--------------------------------|---|----|----------|--------------------------------------|---|----|----------|--------------------------|---|----|----------|---|---|----|----------|-------------|---|----|----------|--------------|---|----|----------|----------------------------------|---|----|
| Code      | Description                               | Image   | Code       | Description                       | Components list   |      |             |     |     |          |                      |   |    |          |                        |   |    |          |                     |       |    |          |                                      |   |    |          |  |       |   |          |                                |   |    |          |                                      |   |    |          |                          |   |    |          |   |   |    |          |             |   |    |          |              |   |    |          |                                  |   |    |
| 0H7274A   | XEVC-2011 RIGHT TROLLEY GUIDE KIT         |    | 0H7274A0   | XEVC-2011 RIGHT TROLLEY GUIDE KIT |   |      |             |     |     |          |                      |   |    |          |                        |   |    |          |                     |       |    |          |                                      |   |    |          |  |       |   |          |                                |   |    |          |                                      |   |    |          |                          |   |    |          |   |   |    |          |             |   |    |          |              |   |    |          |                                  |   |    |
| 0H7275A   | XEVC-2011 LEFT TROLLEY GUIDE KIT          |   | 0H7275A0   | XEVC-2011 LEFT TROLLEY GUIDE KIT  |   |      |             |     |     |          |                      |   |    |          |                        |   |    |          |                     |       |    |          |                                      |   |    |          |  |       |   |          |                                |   |    |          |                                      |   |    |          |                          |   |    |          |   |   |    |          |             |   |    |          |              |   |    |          |                                  |   |    |
| VL1005A   | U-TRAP TANK                               |  | XUC001     | SINGLE UNIT INSTALLATION KIT      | <table border="1"> <thead> <tr> <th>Code</th> <th>Description</th> <th>Qty</th> <th>UOM</th> </tr> </thead> <tbody> <tr> <td>0H6567A0</td> <td>P-TRAP HOLDING PANEL</td> <td>1</td> <td>PZ</td> </tr> <tr> <td>GN1508A0</td> <td>O-RING GASKET COD 2400</td> <td>1</td> <td>PZ</td> </tr> <tr> <td>IL1115A0</td> <td>WOODEN PALET 80X120</td> <td>0.100</td> <td>PZ</td> </tr> <tr> <td>RC1055A0</td> <td>Ø25-40 H12 STAINLESS STEEL PIPE CLIP</td> <td>3</td> <td>PZ</td> </tr> <tr> <td>TB1520A0</td> <td>INT. Ø=38 TH=4 DRAIN BLACK RUBBER PIPE</td> <td>2.500</td> <td>M</td> </tr> <tr> <td>VI1220A1</td> <td>4,2X12 TCB SELF-TAPPIN G SCREW</td> <td>2</td> <td>PZ</td> </tr> <tr> <td>VI1895A0</td> <td>BLIND NUT M4 STAINLESS STEEL DIN 917</td> <td>4</td> <td>PZ</td> </tr> <tr> <td>VI1945A0</td> <td>ENG-VITE M4X20 TCB+ INOX</td> <td>4</td> <td>PZ</td> </tr> <tr> <td>VI1950A0</td> <td>ST. STEEL 4,2X13 TCB SELF-DRILLIN G SCREW</td> <td>2</td> <td>PZ</td> </tr> <tr> <td>VL1005A1</td> <td>U-TRAP TANK</td> <td>1</td> <td>PZ</td> </tr> <tr> <td>VL1006A0</td> <td>SYPHON COVER</td> <td>1</td> <td>PZ</td> </tr> <tr> <td>VM1015A1</td> <td>STAINLESS STEEL Ø30X1.5 90° BEND</td> <td>1</td> <td>PZ</td> </tr> </tbody> </table> | Code | Description | Qty | UOM | 0H6567A0 | P-TRAP HOLDING PANEL | 1 | PZ | GN1508A0 | O-RING GASKET COD 2400 | 1 | PZ | IL1115A0 | WOODEN PALET 80X120 | 0.100 | PZ | RC1055A0 | Ø25-40 H12 STAINLESS STEEL PIPE CLIP | 3 | PZ | TB1520A0 | INT. Ø=38 TH=4 DRAIN BLACK RUBBER PIPE | 2.500 | M | VI1220A1 | 4,2X12 TCB SELF-TAPPIN G SCREW | 2 | PZ | VI1895A0 | BLIND NUT M4 STAINLESS STEEL DIN 917 | 4 | PZ | VI1945A0 | ENG-VITE M4X20 TCB+ INOX | 4 | PZ | VI1950A0 | ST. STEEL 4,2X13 TCB SELF-DRILLIN G SCREW | 2 | PZ | VL1005A1 | U-TRAP TANK | 1 | PZ | VL1006A0 | SYPHON COVER | 1 | PZ | VM1015A1 | STAINLESS STEEL Ø30X1.5 90° BEND | 1 | PZ |
| Code      | Description                               | Qty   | UOM        |                                   |   |      |             |     |     |          |                      |   |    |          |                        |   |    |          |                     |       |    |          |                                      |   |    |          |  |       |   |          |                                |   |    |          |                                      |   |    |          |                          |   |    |          |   |   |    |          |             |   |    |          |              |   |    |          |                                  |   |    |
| 0H6567A0  | P-TRAP HOLDING PANEL                      | 1   | PZ         |                                   |   |      |             |     |     |          |                      |   |    |          |                        |   |    |          |                     |       |    |          |                                      |   |    |          |  |       |   |          |                                |   |    |          |                                      |   |    |          |                          |   |    |          |   |   |    |          |             |   |    |          |              |   |    |          |                                  |   |    |
| GN1508A0  | O-RING GASKET COD 2400                    | 1   | PZ         |                                   |   |      |             |     |     |          |                      |   |    |          |                        |   |    |          |                     |       |    |          |                                      |   |    |          |  |       |   |          |                                |   |    |          |                                      |   |    |          |                          |   |    |          |   |   |    |          |             |   |    |          |              |   |    |          |                                  |   |    |
| IL1115A0  | WOODEN PALET 80X120                       | 0.100   | PZ         |                                   |   |      |             |     |     |          |                      |   |    |          |                        |   |    |          |                     |       |    |          |                                      |   |    |          |  |       |   |          |                                |   |    |          |                                      |   |    |          |                          |   |    |          |   |   |    |          |             |   |    |          |              |   |    |          |                                  |   |    |
| RC1055A0  | Ø25-40 H12 STAINLESS STEEL PIPE CLIP      | 3   | PZ         |                                   |   |      |             |     |     |          |                      |   |    |          |                        |   |    |          |                     |       |    |          |                                      |   |    |          |  |       |   |          |                                |   |    |          |                                      |   |    |          |                          |   |    |          |   |   |    |          |             |   |    |          |              |   |    |          |                                  |   |    |
| TB1520A0  | INT. Ø=38 TH=4 DRAIN BLACK RUBBER PIPE    | 2.500   | M          |                                   |   |      |             |     |     |          |                      |   |    |          |                        |   |    |          |                     |       |    |          |                                      |   |    |          |  |       |   |          |                                |   |    |          |                                      |   |    |          |                          |   |    |          |   |   |    |          |             |   |    |          |              |   |    |          |                                  |   |    |
| VI1220A1  | 4,2X12 TCB SELF-TAPPIN G SCREW            | 2   | PZ         |                                   |   |      |             |     |     |          |                      |   |    |          |                        |   |    |          |                     |       |    |          |                                      |   |    |          |  |       |   |          |                                |   |    |          |                                      |   |    |          |                          |   |    |          |   |   |    |          |             |   |    |          |              |   |    |          |                                  |   |    |
| VI1895A0  | BLIND NUT M4 STAINLESS STEEL DIN 917      | 4   | PZ         |                                   |   |      |             |     |     |          |                      |   |    |          |                        |   |    |          |                     |       |    |          |                                      |   |    |          |  |       |   |          |                                |   |    |          |                                      |   |    |          |                          |   |    |          |   |   |    |          |             |   |    |          |              |   |    |          |                                  |   |    |
| VI1945A0  | ENG-VITE M4X20 TCB+ INOX                  | 4   | PZ         |                                   |   |      |             |     |     |          |                      |   |    |          |                        |   |    |          |                     |       |    |          |                                      |   |    |          |  |       |   |          |                                |   |    |          |                                      |   |    |          |                          |   |    |          |   |   |    |          |             |   |    |          |              |   |    |          |                                  |   |    |
| VI1950A0  | ST. STEEL 4,2X13 TCB SELF-DRILLIN G SCREW | 2   | PZ         |                                   |   |      |             |     |     |          |                      |   |    |          |                        |   |    |          |                     |       |    |          |                                      |   |    |          |  |       |   |          |                                |   |    |          |                                      |   |    |          |                          |   |    |          |   |   |    |          |             |   |    |          |              |   |    |          |                                  |   |    |
| VL1005A1  | U-TRAP TANK                               | 1   | PZ         |                                   |   |      |             |     |     |          |                      |   |    |          |                        |   |    |          |                     |       |    |          |                                      |   |    |          |  |       |   |          |                                |   |    |          |                                      |   |    |          |                          |   |    |          |   |   |    |          |             |   |    |          |              |   |    |          |                                  |   |    |
| VL1006A0  | SYPHON COVER                              | 1   | PZ         |                                   |   |      |             |     |     |          |                      |   |    |          |                        |   |    |          |                     |       |    |          |                                      |   |    |          |  |       |   |          |                                |   |    |          |                                      |   |    |          |                          |   |    |          |   |   |    |          |             |   |    |          |              |   |    |          |                                  |   |    |
| VM1015A1  | STAINLESS STEEL Ø30X1.5 90° BEND          | 1   | PZ         |                                   |   |      |             |     |     |          |                      |   |    |          |                        |   |    |          |                     |       |    |          |                                      |   |    |          |  |       |   |          |                                |   |    |          |                                      |   |    |          |                          |   |    |          |   |   |    |          |             |   |    |          |              |   |    |          |                                  |   |    |

| COMPONENT |   |   | SPARE PART |  |  |      |             |     |     |          |                             |   |    |          |   |   |    |          |  |   |    |          |                      |   |    |          |                             |   |    |          |  |   |    |          |   |   |    |          |                              |   |    |          |                    |    |    |          |   |    |    |          |                         |   |    |          |                            |   |    |          |              |   |    |          |                                       |   |    |          |   |   |   |          |   |    |   |          |  |   |   |          |              |   |   |          |                                      |    |    |
|-----------|---|---|------------|--|--|------|-------------|-----|-----|----------|-----------------------------|---|----|----------|---|---|----|----------|--|---|----|----------|----------------------|---|----|----------|-----------------------------|---|----|----------|--|---|----|----------|---|---|----|----------|------------------------------|---|----|----------|--------------------|----|----|----------|---|----|----|----------|-------------------------|---|----|----------|----------------------------|---|----|----------|--------------|---|----|----------|---------------------------------------|---|----|----------|---|---|---|----------|---|----|---|----------|--|---|---|----------|--------------|---|---|----------|--------------------------------------|----|----|
| Code      | Description                                       | Image   | Code       | Description                              | Components list  |      |             |     |     |          |                             |   |    |          |   |   |    |          |  |   |    |          |                      |   |    |          |                             |   |    |          |  |   |    |          |   |   |    |          |                              |   |    |          |                    |    |    |          |   |    |    |          |                         |   |    |          |                            |   |    |          |              |   |    |          |                                       |   |    |          |   |   |   |          |   |    |   |          |  |   |   |          |              |   |   |          |                                      |    |    |
| VL1005A   | U-TRAP TANK                                       |  | XC761      | 3 OVENS LM TOP<br>XFT200 STACKING<br>KIT | <table border="1"> <thead> <tr> <th>Code</th> <th>Description</th> <th>Qty</th> <th>UOM</th> </tr> </thead> <tbody> <tr> <td>0H1237A0</td> <td>LM TOP<br/>SIPHON<br/>SUPPORT</td> <td>3</td> <td>PZ</td> </tr> <tr> <td>0H7082A0</td> <td>LM 800 XC<br/>STACKING KIT<br/>FRONT<br/>PROFILE</td> <td>2</td> <td>PZ</td> </tr> <tr> <td>0H7083A0</td> <td>LM 800 XC<br/>STACKING KIT<br/>BACK PROFIL</td> <td>4</td> <td>PZ</td> </tr> <tr> <td>ED1246A0</td> <td>HOT SURFACE<br/>LABEL</td> <td>1</td> <td>PZ</td> </tr> <tr> <td>ED1271A0</td> <td>LIQUID FALLS<br/>DANGER LABE</td> <td>1</td> <td>PZ</td> </tr> <tr> <td>EL1020A1</td> <td>D8<br/>INTERMEDIAT<br/>E T-SHAPED<br/>FITTING</td> <td>4</td> <td>PZ</td> </tr> <tr> <td>EL1180A0</td> <td>Ø8-Ø8<br/>FEMALE<br/>NON-RETURN<br/>CONNECTION</td> <td>3</td> <td>PZ</td> </tr> <tr> <td>GN1508A0</td> <td>O-RING<br/>GASKET COD<br/>2400</td> <td>3</td> <td>PZ</td> </tr> <tr> <td>RC1008A0</td> <td>D9 ELASTIC<br/>CLIP</td> <td>12</td> <td>PZ</td> </tr> <tr> <td>RC1055A0</td> <td>Ø25-40 H12<br/>STAINLESS<br/>STEEL PIPE<br/>CLIP</td> <td>15</td> <td>PZ</td> </tr> <tr> <td>RC1297A1</td> <td>D10 T-SHAPED<br/>FITTING</td> <td>2</td> <td>PZ</td> </tr> <tr> <td>RC1360A0</td> <td>10 - 10 JG<br/>ELBOW FITTIN</td> <td>1</td> <td>PZ</td> </tr> <tr> <td>RC1376A0</td> <td>Ø6 Y-FITTING</td> <td>2</td> <td>PZ</td> </tr> <tr> <td>TB1177A0</td> <td>FOOT PANEL<br/>40X40 H58<br/>OVERLAP LM</td> <td>8</td> <td>PZ</td> </tr> <tr> <td>TB1520A0</td> <td>INT. Ø=38<br/>TH=4 DRAIN<br/>BLACK<br/>RUBBER PIPE</td> <td>5</td> <td>M</td> </tr> <tr> <td>TB1815A0</td> <td>7,93X4,75 PE<br/>TRANSP. PIPE<br/>(JG<br/>#PE08100N)</td> <td>12</td> <td>M</td> </tr> <tr> <td>TB1816A0</td> <td>CLEAR<br/>POLYPROPYL<br/>ENE PIPE<br/>6X4MM</td> <td>3</td> <td>M</td> </tr> <tr> <td>TB2243A0</td> <td>Ø10 PET PIPE</td> <td>4</td> <td>M</td> </tr> <tr> <td>VI1220A1</td> <td>4,2X12 TCB<br/>SELF-TAPPIN<br/>G SCREW</td> <td>30</td> <td>PZ</td> </tr> </tbody> </table> | Code | Description | Qty | UOM | 0H1237A0 | LM TOP<br>SIPHON<br>SUPPORT | 3 | PZ | 0H7082A0 | LM 800 XC<br>STACKING KIT<br>FRONT<br>PROFILE | 2 | PZ | 0H7083A0 | LM 800 XC<br>STACKING KIT<br>BACK PROFIL | 4 | PZ | ED1246A0 | HOT SURFACE<br>LABEL | 1 | PZ | ED1271A0 | LIQUID FALLS<br>DANGER LABE | 1 | PZ | EL1020A1 | D8<br>INTERMEDIAT<br>E T-SHAPED<br>FITTING | 4 | PZ | EL1180A0 | Ø8-Ø8<br>FEMALE<br>NON-RETURN<br>CONNECTION | 3 | PZ | GN1508A0 | O-RING<br>GASKET COD<br>2400 | 3 | PZ | RC1008A0 | D9 ELASTIC<br>CLIP | 12 | PZ | RC1055A0 | Ø25-40 H12<br>STAINLESS<br>STEEL PIPE<br>CLIP | 15 | PZ | RC1297A1 | D10 T-SHAPED<br>FITTING | 2 | PZ | RC1360A0 | 10 - 10 JG<br>ELBOW FITTIN | 1 | PZ | RC1376A0 | Ø6 Y-FITTING | 2 | PZ | TB1177A0 | FOOT PANEL<br>40X40 H58<br>OVERLAP LM | 8 | PZ | TB1520A0 | INT. Ø=38<br>TH=4 DRAIN<br>BLACK<br>RUBBER PIPE | 5 | M | TB1815A0 | 7,93X4,75 PE<br>TRANSP. PIPE<br>(JG<br>#PE08100N) | 12 | M | TB1816A0 | CLEAR<br>POLYPROPYL<br>ENE PIPE<br>6X4MM | 3 | M | TB2243A0 | Ø10 PET PIPE | 4 | M | VI1220A1 | 4,2X12 TCB<br>SELF-TAPPIN<br>G SCREW | 30 | PZ |
| Code      | Description                                       | Qty   | UOM        |  |  |      |             |     |     |          |                             |   |    |          |   |   |    |          |  |   |    |          |                      |   |    |          |                             |   |    |          |  |   |    |          |   |   |    |          |                              |   |    |          |                    |    |    |          |   |    |    |          |                         |   |    |          |                            |   |    |          |              |   |    |          |                                       |   |    |          |   |   |   |          |   |    |   |          |  |   |   |          |              |   |   |          |                                      |    |    |
| 0H1237A0  | LM TOP<br>SIPHON<br>SUPPORT                       | 3   | PZ         |  |  |      |             |     |     |          |                             |   |    |          |   |   |    |          |  |   |    |          |                      |   |    |          |                             |   |    |          |  |   |    |          |   |   |    |          |                              |   |    |          |                    |    |    |          |   |    |    |          |                         |   |    |          |                            |   |    |          |              |   |    |          |                                       |   |    |          |   |   |   |          |   |    |   |          |  |   |   |          |              |   |   |          |                                      |    |    |
| 0H7082A0  | LM 800 XC<br>STACKING KIT<br>FRONT<br>PROFILE     | 2   | PZ         |  |  |      |             |     |     |          |                             |   |    |          |   |   |    |          |  |   |    |          |                      |   |    |          |                             |   |    |          |  |   |    |          |   |   |    |          |                              |   |    |          |                    |    |    |          |   |    |    |          |                         |   |    |          |                            |   |    |          |              |   |    |          |                                       |   |    |          |   |   |   |          |   |    |   |          |  |   |   |          |              |   |   |          |                                      |    |    |
| 0H7083A0  | LM 800 XC<br>STACKING KIT<br>BACK PROFIL          | 4   | PZ         |  |  |      |             |     |     |          |                             |   |    |          |   |   |    |          |  |   |    |          |                      |   |    |          |                             |   |    |          |  |   |    |          |   |   |    |          |                              |   |    |          |                    |    |    |          |   |    |    |          |                         |   |    |          |                            |   |    |          |              |   |    |          |                                       |   |    |          |   |   |   |          |   |    |   |          |  |   |   |          |              |   |   |          |                                      |    |    |
| ED1246A0  | HOT SURFACE<br>LABEL                              | 1   | PZ         |  |  |      |             |     |     |          |                             |   |    |          |   |   |    |          |  |   |    |          |                      |   |    |          |                             |   |    |          |  |   |    |          |   |   |    |          |                              |   |    |          |                    |    |    |          |   |    |    |          |                         |   |    |          |                            |   |    |          |              |   |    |          |                                       |   |    |          |   |   |   |          |   |    |   |          |  |   |   |          |              |   |   |          |                                      |    |    |
| ED1271A0  | LIQUID FALLS<br>DANGER LABE                       | 1   | PZ         |  |  |      |             |     |     |          |                             |   |    |          |   |   |    |          |  |   |    |          |                      |   |    |          |                             |   |    |          |  |   |    |          |   |   |    |          |                              |   |    |          |                    |    |    |          |   |    |    |          |                         |   |    |          |                            |   |    |          |              |   |    |          |                                       |   |    |          |   |   |   |          |   |    |   |          |  |   |   |          |              |   |   |          |                                      |    |    |
| EL1020A1  | D8<br>INTERMEDIAT<br>E T-SHAPED<br>FITTING        | 4   | PZ         |  |  |      |             |     |     |          |                             |   |    |          |   |   |    |          |  |   |    |          |                      |   |    |          |                             |   |    |          |  |   |    |          |   |   |    |          |                              |   |    |          |                    |    |    |          |   |    |    |          |                         |   |    |          |                            |   |    |          |              |   |    |          |                                       |   |    |          |   |   |   |          |   |    |   |          |  |   |   |          |              |   |   |          |                                      |    |    |
| EL1180A0  | Ø8-Ø8<br>FEMALE<br>NON-RETURN<br>CONNECTION       | 3   | PZ         |  |  |      |             |     |     |          |                             |   |    |          |   |   |    |          |  |   |    |          |                      |   |    |          |                             |   |    |          |  |   |    |          |   |   |    |          |                              |   |    |          |                    |    |    |          |   |    |    |          |                         |   |    |          |                            |   |    |          |              |   |    |          |                                       |   |    |          |   |   |   |          |   |    |   |          |  |   |   |          |              |   |   |          |                                      |    |    |
| GN1508A0  | O-RING<br>GASKET COD<br>2400                      | 3   | PZ         |  |  |      |             |     |     |          |                             |   |    |          |   |   |    |          |  |   |    |          |                      |   |    |          |                             |   |    |          |  |   |    |          |   |   |    |          |                              |   |    |          |                    |    |    |          |   |    |    |          |                         |   |    |          |                            |   |    |          |              |   |    |          |                                       |   |    |          |   |   |   |          |   |    |   |          |  |   |   |          |              |   |   |          |                                      |    |    |
| RC1008A0  | D9 ELASTIC<br>CLIP                                | 12  | PZ         |  |  |      |             |     |     |          |                             |   |    |          |   |   |    |          |  |   |    |          |                      |   |    |          |                             |   |    |          |  |   |    |          |   |   |    |          |                              |   |    |          |                    |    |    |          |   |    |    |          |                         |   |    |          |                            |   |    |          |              |   |    |          |                                       |   |    |          |   |   |   |          |   |    |   |          |  |   |   |          |              |   |   |          |                                      |    |    |
| RC1055A0  | Ø25-40 H12<br>STAINLESS<br>STEEL PIPE<br>CLIP     | 15  | PZ         |  |  |      |             |     |     |          |                             |   |    |          |   |   |    |          |  |   |    |          |                      |   |    |          |                             |   |    |          |  |   |    |          |   |   |    |          |                              |   |    |          |                    |    |    |          |   |    |    |          |                         |   |    |          |                            |   |    |          |              |   |    |          |                                       |   |    |          |   |   |   |          |   |    |   |          |  |   |   |          |              |   |   |          |                                      |    |    |
| RC1297A1  | D10 T-SHAPED<br>FITTING                           | 2   | PZ         |  |  |      |             |     |     |          |                             |   |    |          |   |   |    |          |  |   |    |          |                      |   |    |          |                             |   |    |          |  |   |    |          |   |   |    |          |                              |   |    |          |                    |    |    |          |   |    |    |          |                         |   |    |          |                            |   |    |          |              |   |    |          |                                       |   |    |          |   |   |   |          |   |    |   |          |  |   |   |          |              |   |   |          |                                      |    |    |
| RC1360A0  | 10 - 10 JG<br>ELBOW FITTIN                        | 1   | PZ         |  |  |      |             |     |     |          |                             |   |    |          |   |   |    |          |  |   |    |          |                      |   |    |          |                             |   |    |          |  |   |    |          |   |   |    |          |                              |   |    |          |                    |    |    |          |   |    |    |          |                         |   |    |          |                            |   |    |          |              |   |    |          |                                       |   |    |          |   |   |   |          |   |    |   |          |  |   |   |          |              |   |   |          |                                      |    |    |
| RC1376A0  | Ø6 Y-FITTING                                      | 2   | PZ         |  |  |      |             |     |     |          |                             |   |    |          |   |   |    |          |  |   |    |          |                      |   |    |          |                             |   |    |          |  |   |    |          |   |   |    |          |                              |   |    |          |                    |    |    |          |   |    |    |          |                         |   |    |          |                            |   |    |          |              |   |    |          |                                       |   |    |          |   |   |   |          |   |    |   |          |  |   |   |          |              |   |   |          |                                      |    |    |
| TB1177A0  | FOOT PANEL<br>40X40 H58<br>OVERLAP LM             | 8   | PZ         |  |  |      |             |     |     |          |                             |   |    |          |   |   |    |          |  |   |    |          |                      |   |    |          |                             |   |    |          |  |   |    |          |   |   |    |          |                              |   |    |          |                    |    |    |          |   |    |    |          |                         |   |    |          |                            |   |    |          |              |   |    |          |                                       |   |    |          |   |   |   |          |   |    |   |          |  |   |   |          |              |   |   |          |                                      |    |    |
| TB1520A0  | INT. Ø=38<br>TH=4 DRAIN<br>BLACK<br>RUBBER PIPE   | 5   | M          |  |  |      |             |     |     |          |                             |   |    |          |   |   |    |          |  |   |    |          |                      |   |    |          |                             |   |    |          |  |   |    |          |   |   |    |          |                              |   |    |          |                    |    |    |          |   |    |    |          |                         |   |    |          |                            |   |    |          |              |   |    |          |                                       |   |    |          |   |   |   |          |   |    |   |          |  |   |   |          |              |   |   |          |                                      |    |    |
| TB1815A0  | 7,93X4,75 PE<br>TRANSP. PIPE<br>(JG<br>#PE08100N) | 12  | M          |  |  |      |             |     |     |          |                             |   |    |          |   |   |    |          |  |   |    |          |                      |   |    |          |                             |   |    |          |  |   |    |          |   |   |    |          |                              |   |    |          |                    |    |    |          |   |    |    |          |                         |   |    |          |                            |   |    |          |              |   |    |          |                                       |   |    |          |   |   |   |          |   |    |   |          |  |   |   |          |              |   |   |          |                                      |    |    |
| TB1816A0  | CLEAR<br>POLYPROPYL<br>ENE PIPE<br>6X4MM          | 3   | M          |  |  |      |             |     |     |          |                             |   |    |          |   |   |    |          |  |   |    |          |                      |   |    |          |                             |   |    |          |  |   |    |          |   |   |    |          |                              |   |    |          |                    |    |    |          |   |    |    |          |                         |   |    |          |                            |   |    |          |              |   |    |          |                                       |   |    |          |   |   |   |          |   |    |   |          |  |   |   |          |              |   |   |          |                                      |    |    |
| TB2243A0  | Ø10 PET PIPE                                      | 4   | M          |  |  |      |             |     |     |          |                             |   |    |          |   |   |    |          |  |   |    |          |                      |   |    |          |                             |   |    |          |  |   |    |          |   |   |    |          |                              |   |    |          |                    |    |    |          |   |    |    |          |                         |   |    |          |                            |   |    |          |              |   |    |          |                                       |   |    |          |   |   |   |          |   |    |   |          |  |   |   |          |              |   |   |          |                                      |    |    |
| VI1220A1  | 4,2X12 TCB<br>SELF-TAPPIN<br>G SCREW              | 30  | PZ         |  |  |      |             |     |     |          |                             |   |    |          |   |   |    |          |  |   |    |          |                      |   |    |          |                             |   |    |          |  |   |    |          |   |   |    |          |                              |   |    |          |                    |    |    |          |   |    |    |          |                         |   |    |          |                            |   |    |          |              |   |    |          |                                       |   |    |          |   |   |   |          |   |    |   |          |  |   |   |          |              |   |   |          |                                      |    |    |



PLATON SERVICE  
8 (800) 500-34-47  
www.platonservice.com

| COMPONENT |  |  | SPARE PART |  |  |      |             |                        |     |          |  |                            |    |          |                                |                      |    |          |  |                             |    |          |             |  |    |          |                 |                              |    |          |   |                               |    |          |   |                    |    |          |                             |   |    |          |                       |              |    |    |          |                         |   |    |          |              |   |    |
|-----------|--|--|------------|--|--|------|-------------|------------------------|-----|----------|--|----------------------------|----|----------|--------------------------------|----------------------|----|----------|--|-----------------------------|----|----------|-------------|--|----|----------|-----------------|------------------------------|----|----------|---|-------------------------------|----|----------|---|--------------------|----|----------|-----------------------------|---|----|----------|-----------------------|--------------|----|----|----------|-------------------------|---|----|----------|--------------|---|----|
| Code      | Description  | Image  | Code       | Description                              | Components list  |      |             |                        |     |          |  |                            |    |          |                                |                      |    |          |  |                             |    |          |             |  |    |          |                 |                              |    |          |   |                               |    |          |   |                    |    |          |                             |   |    |          |                       |              |    |    |          |                         |   |    |          |              |   |    |
| VL1005A   | U-TRAP TANK  |   | XC761      | 3 OVENS LM TOP<br>XFT200 STACKING<br>KIT | <table border="1"> <thead> <tr> <th>Code</th> <th>Description</th> <th>Qty</th> <th>UOM</th> </tr> </thead> <tbody> <tr> <td>VI1895A0</td> <td>BLIND NUT M4<br/>STAINLESS<br/>STEEL DIN 917</td> <td>12</td> <td>PZ</td> </tr> <tr> <td>VI1945A0</td> <td>ENG-VITE<br/>M4X20 TCB+<br/>INOX</td> <td>12</td> <td>PZ</td> </tr> <tr> <td>VI1950A0</td> <td>ST. STEEL<br/>4,2X13 TCB<br/>SELF-DRILLIN<br/>G SCREW</td> <td>20</td> <td>PZ</td> </tr> <tr> <td>VL1005A1</td> <td>U-TRAP TANK</td> <td>3</td> <td>PZ</td> </tr> <tr> <td>VL1006A0</td> <td>SYPHON<br/>COVER</td> <td>3</td> <td>PZ</td> </tr> <tr> <td>VL1046A1</td> <td>D6 PIPE<br/>HOLDER - D6<br/>J.G. TERMINAL</td> <td>12</td> <td>PZ</td> </tr> <tr> <td>VM1015A1</td> <td>STAINLESS<br/>STEEL<br/>Ø30X1,5 90°<br/>BEND</td> <td>1</td> <td>PZ</td> </tr> <tr> <td>VM1794A0</td> <td>250X4,8 PA66<br/>BLACK CLAMP</td> <td>3</td> <td>PZ</td> </tr> <tr> <td>VM2035A0</td> <td>DRAIN PIPE<br/>SUPPORT</td> <td>3</td> <td>PZ</td> </tr> </tbody> </table> | Code | Description | Qty                    | UOM | VI1895A0 | BLIND NUT M4<br>STAINLESS<br>STEEL DIN 917 | 12                         | PZ | VI1945A0 | ENG-VITE<br>M4X20 TCB+<br>INOX | 12                   | PZ | VI1950A0 | ST. STEEL<br>4,2X13 TCB<br>SELF-DRILLIN<br>G SCREW | 20                          | PZ | VL1005A1 | U-TRAP TANK | 3  | PZ | VL1006A0 | SYPHON<br>COVER | 3                            | PZ | VL1046A1 | D6 PIPE<br>HOLDER - D6<br>J.G. TERMINAL | 12                            | PZ | VM1015A1 | STAINLESS<br>STEEL<br>Ø30X1,5 90°<br>BEND | 1                  | PZ | VM1794A0 | 250X4,8 PA66<br>BLACK CLAMP | 3   | PZ | VM2035A0 | DRAIN PIPE<br>SUPPORT | 3            | PZ |    |          |                         |   |    |          |              |   |    |
|           |  |  | Code       | Description                              | Qty  | UOM  |             |                        |     |          |  |                            |    |          |                                |                      |    |          |  |                             |    |          |             |  |    |          |                 |                              |    |          |   |                               |    |          |   |                    |    |          |                             |   |    |          |                       |              |    |    |          |                         |   |    |          |              |   |    |
| VI1895A0  | BLIND NUT M4<br>STAINLESS<br>STEEL DIN 917         | 12   | PZ         |  |  |      |             |                        |     |          |  |                            |    |          |                                |                      |    |          |  |                             |    |          |             |  |    |          |                 |                              |    |          |   |                               |    |          |   |                    |    |          |                             |   |    |          |                       |              |    |    |          |                         |   |    |          |              |   |    |
| VI1945A0  | ENG-VITE<br>M4X20 TCB+<br>INOX                     | 12   | PZ         |  |  |      |             |                        |     |          |  |                            |    |          |                                |                      |    |          |  |                             |    |          |             |  |    |          |                 |                              |    |          |   |                               |    |          |   |                    |    |          |                             |   |    |          |                       |              |    |    |          |                         |   |    |          |              |   |    |
| VI1950A0  | ST. STEEL<br>4,2X13 TCB<br>SELF-DRILLIN<br>G SCREW | 20   | PZ         |  |  |      |             |                        |     |          |  |                            |    |          |                                |                      |    |          |  |                             |    |          |             |  |    |          |                 |                              |    |          |   |                               |    |          |   |                    |    |          |                             |   |    |          |                       |              |    |    |          |                         |   |    |          |              |   |    |
| VL1005A1  | U-TRAP TANK  | 3  | PZ         |  |  |      |             |                        |     |          |  |                            |    |          |                                |                      |    |          |  |                             |    |          |             |  |    |          |                 |                              |    |          |   |                               |    |          |   |                    |    |          |                             |   |    |          |                       |              |    |    |          |                         |   |    |          |              |   |    |
| VL1006A0  | SYPHON<br>COVER                                    | 3  | PZ         |  |  |      |             |                        |     |          |  |                            |    |          |                                |                      |    |          |  |                             |    |          |             |  |    |          |                 |                              |    |          |   |                               |    |          |   |                    |    |          |                             |   |    |          |                       |              |    |    |          |                         |   |    |          |              |   |    |
| VL1046A1  | D6 PIPE<br>HOLDER - D6<br>J.G. TERMINAL            | 12   | PZ         |  |  |      |             |                        |     |          |  |                            |    |          |                                |                      |    |          |  |                             |    |          |             |  |    |          |                 |                              |    |          |   |                               |    |          |   |                    |    |          |                             |   |    |          |                       |              |    |    |          |                         |   |    |          |              |   |    |
| VM1015A1  | STAINLESS<br>STEEL<br>Ø30X1,5 90°<br>BEND          | 1  | PZ         |  |  |      |             |                        |     |          |  |                            |    |          |                                |                      |    |          |  |                             |    |          |             |  |    |          |                 |                              |    |          |   |                               |    |          |   |                    |    |          |                             |   |    |          |                       |              |    |    |          |                         |   |    |          |              |   |    |
| VM1794A0  | 250X4,8 PA66<br>BLACK CLAMP                        | 3  | PZ         |  |  |      |             |                        |     |          |  |                            |    |          |                                |                      |    |          |  |                             |    |          |             |  |    |          |                 |                              |    |          |   |                               |    |          |   |                    |    |          |                             |   |    |          |                       |              |    |    |          |                         |   |    |          |              |   |    |
| VM2035A0  | DRAIN PIPE<br>SUPPORT                              | 3  | PZ         |  |  |      |             |                        |     |          |  |                            |    |          |                                |                      |    |          |  |                             |    |          |             |  |    |          |                 |                              |    |          |   |                               |    |          |   |                    |    |          |                             |   |    |          |                       |              |    |    |          |                         |   |    |          |              |   |    |
| XC757     | S. E CHEFTOP<br>GN1/1 STACKING KI                  | <table border="1"> <thead> <tr> <th>Code</th> <th>Description</th> <th>Qty</th> <th>UOM</th> </tr> </thead> <tbody> <tr> <td>0H6463A0</td> <td>XC757 FRONT<br/>PROFILE</td> <td>1</td> <td>PZ</td> </tr> <tr> <td>CE1305A0</td> <td>L=2MT RJ45 -<br/>RJ45 CABLE</td> <td>1</td> <td>PZ</td> </tr> <tr> <td>ED1246A0</td> <td>HOT SURFACE<br/>LABEL</td> <td>2</td> <td>PZ</td> </tr> <tr> <td>ED1271A0</td> <td>LIQUID FALLS<br/>DANGER LABE</td> <td>1</td> <td>PZ</td> </tr> <tr> <td>EL1020A1</td> <td>D8<br/>INTERMEDIAT<br/>E T-SHAPED<br/>FITTING</td> <td>2</td> <td>PZ</td> </tr> <tr> <td>GN1508A0</td> <td>O-RING<br/>GASKET COD<br/>2400</td> <td>2</td> <td>PZ</td> </tr> <tr> <td>PD1069A0</td> <td>FOOT<br/>OVERLAP S5<br/>CT-BT-E</td> <td>1</td> <td>PZ</td> </tr> <tr> <td>RC1008A0</td> <td>D9 ELASTIC<br/>CLIP</td> <td>3</td> <td>PZ</td> </tr> <tr> <td>RC1055A0</td> <td>Ø25-40 H12<br/>STAINLESS<br/>STEEL PIPE<br/>CLIP</td> <td>14</td> <td>PZ</td> </tr> <tr> <td>RC1130A0</td> <td>130X2,6 CLAM</td> <td>3</td> <td>PZ</td> </tr> <tr> <td>RC1297A1</td> <td>D10 T-SHAPED<br/>FITTING</td> <td>1</td> <td>PZ</td> </tr> <tr> <td>RC1376A0</td> <td>Ø6 Y-FITTING</td> <td>1</td> <td>PZ</td> </tr> </tbody> </table> | Code       | Description                              | Qty  | UOM  | 0H6463A0    | XC757 FRONT<br>PROFILE | 1   | PZ       | CE1305A0                                   | L=2MT RJ45 -<br>RJ45 CABLE | 1  | PZ       | ED1246A0                       | HOT SURFACE<br>LABEL | 2  | PZ       | ED1271A0   | LIQUID FALLS<br>DANGER LABE | 1  | PZ       | EL1020A1    | D8<br>INTERMEDIAT<br>E T-SHAPED<br>FITTING | 2  | PZ       | GN1508A0        | O-RING<br>GASKET COD<br>2400 | 2  | PZ       | PD1069A0                                | FOOT<br>OVERLAP S5<br>CT-BT-E | 1  | PZ       | RC1008A0                                  | D9 ELASTIC<br>CLIP | 3  | PZ       | RC1055A0                    | Ø25-40 H12<br>STAINLESS<br>STEEL PIPE<br>CLIP | 14 | PZ       | RC1130A0              | 130X2,6 CLAM | 3  | PZ | RC1297A1 | D10 T-SHAPED<br>FITTING | 1 | PZ | RC1376A0 | Ø6 Y-FITTING | 1 | PZ |
| Code      | Description  | Qty  | UOM        |  |  |      |             |                        |     |          |  |                            |    |          |                                |                      |    |          |  |                             |    |          |             |  |    |          |                 |                              |    |          |   |                               |    |          |   |                    |    |          |                             |   |    |          |                       |              |    |    |          |                         |   |    |          |              |   |    |
| 0H6463A0  | XC757 FRONT<br>PROFILE                             | 1  | PZ         |  |  |      |             |                        |     |          |  |                            |    |          |                                |                      |    |          |  |                             |    |          |             |  |    |          |                 |                              |    |          |   |                               |    |          |   |                    |    |          |                             |   |    |          |                       |              |    |    |          |                         |   |    |          |              |   |    |
| CE1305A0  | L=2MT RJ45 -<br>RJ45 CABLE                         | 1  | PZ         |  |  |      |             |                        |     |          |  |                            |    |          |                                |                      |    |          |  |                             |    |          |             |  |    |          |                 |                              |    |          |   |                               |    |          |   |                    |    |          |                             |   |    |          |                       |              |    |    |          |                         |   |    |          |              |   |    |
| ED1246A0  | HOT SURFACE<br>LABEL                               | 2  | PZ         |  |  |      |             |                        |     |          |  |                            |    |          |                                |                      |    |          |  |                             |    |          |             |  |    |          |                 |                              |    |          |   |                               |    |          |   |                    |    |          |                             |   |    |          |                       |              |    |    |          |                         |   |    |          |              |   |    |
| ED1271A0  | LIQUID FALLS<br>DANGER LABE                        | 1  | PZ         |  |  |      |             |                        |     |          |  |                            |    |          |                                |                      |    |          |  |                             |    |          |             |  |    |          |                 |                              |    |          |   |                               |    |          |   |                    |    |          |                             |   |    |          |                       |              |    |    |          |                         |   |    |          |              |   |    |
| EL1020A1  | D8<br>INTERMEDIAT<br>E T-SHAPED<br>FITTING         | 2  | PZ         |  |  |      |             |                        |     |          |  |                            |    |          |                                |                      |    |          |  |                             |    |          |             |  |    |          |                 |                              |    |          |   |                               |    |          |   |                    |    |          |                             |   |    |          |                       |              |    |    |          |                         |   |    |          |              |   |    |
| GN1508A0  | O-RING<br>GASKET COD<br>2400                       | 2  | PZ         |  |  |      |             |                        |     |          |  |                            |    |          |                                |                      |    |          |  |                             |    |          |             |  |    |          |                 |                              |    |          |   |                               |    |          |   |                    |    |          |                             |   |    |          |                       |              |    |    |          |                         |   |    |          |              |   |    |
| PD1069A0  | FOOT<br>OVERLAP S5<br>CT-BT-E                      | 1  | PZ         |  |  |      |             |                        |     |          |  |                            |    |          |                                |                      |    |          |  |                             |    |          |             |  |    |          |                 |                              |    |          |   |                               |    |          |   |                    |    |          |                             |   |    |          |                       |              |    |    |          |                         |   |    |          |              |   |    |
| RC1008A0  | D9 ELASTIC<br>CLIP                                 | 3  | PZ         |  |  |      |             |                        |     |          |  |                            |    |          |                                |                      |    |          |  |                             |    |          |             |  |    |          |                 |                              |    |          |   |                               |    |          |   |                    |    |          |                             |   |    |          |                       |              |    |    |          |                         |   |    |          |              |   |    |
| RC1055A0  | Ø25-40 H12<br>STAINLESS<br>STEEL PIPE<br>CLIP      | 14   | PZ         |  |  |      |             |                        |     |          |  |                            |    |          |                                |                      |    |          |  |                             |    |          |             |  |    |          |                 |                              |    |          |   |                               |    |          |   |                    |    |          |                             |   |    |          |                       |              |    |    |          |                         |   |    |          |              |   |    |
| RC1130A0  | 130X2,6 CLAM                                       | 3  | PZ         |  |  |      |             |                        |     |          |  |                            |    |          |                                |                      |    |          |  |                             |    |          |             |  |    |          |                 |                              |    |          |   |                               |    |          |   |                    |    |          |                             |   |    |          |                       |              |    |    |          |                         |   |    |          |              |   |    |
| RC1297A1  | D10 T-SHAPED<br>FITTING                            | 1  | PZ         |  |  |      |             |                        |     |          |  |                            |    |          |                                |                      |    |          |  |                             |    |          |             |  |    |          |                 |                              |    |          |   |                               |    |          |   |                    |    |          |                             |   |    |          |                       |              |    |    |          |                         |   |    |          |              |   |    |
| RC1376A0  | Ø6 Y-FITTING                                       | 1  | PZ         |  |  |      |             |                        |     |          |  |                            |    |          |                                |                      |    |          |  |                             |    |          |             |  |    |          |                 |                              |    |          |   |                               |    |          |   |                    |    |          |                             |   |    |          |                       |              |    |    |          |                         |   |    |          |              |   |    |

| COMPONENT |  |   | SPARE PART |                                   |  |      |             |     |     |          |   |   |   |          |   |   |    |          |              |       |   |          |                                      |   |    |          |  |   |    |          |                                |   |    |          |  |    |    |          |             |   |    |          |                 |   |    |          |   |   |    |          |   |   |    |          |   |   |    |          |                             |   |    |          |                                  |   |    |          |                       |   |    |       |                                 |  |      |             |     |     |          |                        |   |    |          |                            |   |    |          |                      |   |    |          |                             |   |    |
|-----------|--|---|------------|-----------------------------------|--|------|-------------|-----|-----|----------|---|---|---|----------|---|---|----|----------|--------------|-------|---|----------|--------------------------------------|---|----|----------|--|---|----|----------|--------------------------------|---|----|----------|--|----|----|----------|-------------|---|----|----------|-----------------|---|----|----------|---|---|----|----------|---|---|----|----------|---|---|----|----------|-----------------------------|---|----|----------|----------------------------------|---|----|----------|-----------------------|---|----|-------|---------------------------------|--|------|-------------|-----|-----|----------|------------------------|---|----|----------|----------------------------|---|----|----------|----------------------|---|----|----------|-----------------------------|---|----|
| Code      | Description  | Image   | Code       | Description                       | Components list  |      |             |     |     |          |   |   |   |          |   |   |    |          |              |       |   |          |                                      |   |    |          |  |   |    |          |                                |   |    |          |  |    |    |          |             |   |    |          |                 |   |    |          |   |   |    |          |   |   |    |          |   |   |    |          |                             |   |    |          |                                  |   |    |          |                       |   |    |       |                                 |  |      |             |     |     |          |                        |   |    |          |                            |   |    |          |                      |   |    |          |                             |   |    |
| VL1005A   | U-TRAP TANK  |  | XC757      | S. E CHEFTOP<br>GN1/1 STACKING KI | <table border="1"> <thead> <tr> <th>Code</th> <th>Description</th> <th>Qty</th> <th>UOM</th> </tr> </thead> <tbody> <tr> <td>TB1520A0</td> <td>INT. Ø=38<br/>TH=4 DRAIN<br/>BLACK<br/>RUBBER PIPE</td> <td>5</td> <td>M</td> </tr> <tr> <td>TB1765A1</td> <td>STACKING KIT<br/>CHIMNEY<br/>CONNECTING<br/>PIPE</td> <td>2</td> <td>PZ</td> </tr> <tr> <td>TB2243A0</td> <td>Ø10 PET PIPE</td> <td>1.500</td> <td>M</td> </tr> <tr> <td>VI1220A1</td> <td>4,2X12 TCB<br/>SELF-TAPPIN<br/>G SCREW</td> <td>4</td> <td>PZ</td> </tr> <tr> <td>VI1895A0</td> <td>BLIND NUT M4<br/>STAINLESS<br/>STEEL DIN 917</td> <td>8</td> <td>PZ</td> </tr> <tr> <td>VI1945A0</td> <td>ENG-VITE<br/>M4X20 TCB+<br/>INOX</td> <td>8</td> <td>PZ</td> </tr> <tr> <td>VI1950A0</td> <td>ST. STEEL<br/>4,2X13 TCB<br/>SELF-DRILLIN<br/>G SCREW</td> <td>26</td> <td>PZ</td> </tr> <tr> <td>VL1005A1</td> <td>U-TRAP TANK</td> <td>2</td> <td>PZ</td> </tr> <tr> <td>VL1006A0</td> <td>SYPHON<br/>COVER</td> <td>2</td> <td>PZ</td> </tr> <tr> <td>VL1043A0</td> <td>D4 PIPE<br/>HOLDER - D6<br/>J.G. TERMINAL</td> <td>3</td> <td>PZ</td> </tr> <tr> <td>VL1046A1</td> <td>D6 PIPE<br/>HOLDER - D6<br/>J.G. TERMINAL</td> <td>3</td> <td>PZ</td> </tr> <tr> <td>VM1015A1</td> <td>STAINLESS<br/>STEEL<br/>Ø30X1.5 90°<br/>BEND</td> <td>1</td> <td>PZ</td> </tr> <tr> <td>VM1794A0</td> <td>250X4.8 PA66<br/>BLACK CLAMP</td> <td>3</td> <td>PZ</td> </tr> <tr> <td>VM1987A0</td> <td>BRACKET FOR<br/>OVENS<br/>STACKING</td> <td>1</td> <td>PZ</td> </tr> <tr> <td>VM2035A0</td> <td>DRAIN PIPE<br/>SUPPORT</td> <td>2</td> <td>PZ</td> </tr> </tbody> </table> | Code | Description | Qty | UOM | TB1520A0 | INT. Ø=38<br>TH=4 DRAIN<br>BLACK<br>RUBBER PIPE | 5 | M | TB1765A1 | STACKING KIT<br>CHIMNEY<br>CONNECTING<br>PIPE | 2 | PZ | TB2243A0 | Ø10 PET PIPE | 1.500 | M | VI1220A1 | 4,2X12 TCB<br>SELF-TAPPIN<br>G SCREW | 4 | PZ | VI1895A0 | BLIND NUT M4<br>STAINLESS<br>STEEL DIN 917 | 8 | PZ | VI1945A0 | ENG-VITE<br>M4X20 TCB+<br>INOX | 8 | PZ | VI1950A0 | ST. STEEL<br>4,2X13 TCB<br>SELF-DRILLIN<br>G SCREW | 26 | PZ | VL1005A1 | U-TRAP TANK | 2 | PZ | VL1006A0 | SYPHON<br>COVER | 2 | PZ | VL1043A0 | D4 PIPE<br>HOLDER - D6<br>J.G. TERMINAL | 3 | PZ | VL1046A1 | D6 PIPE<br>HOLDER - D6<br>J.G. TERMINAL | 3 | PZ | VM1015A1 | STAINLESS<br>STEEL<br>Ø30X1.5 90°<br>BEND | 1 | PZ | VM1794A0 | 250X4.8 PA66<br>BLACK CLAMP | 3 | PZ | VM1987A0 | BRACKET FOR<br>OVENS<br>STACKING | 1 | PZ | VM2035A0 | DRAIN PIPE<br>SUPPORT | 2 | PZ | XC756 | E SERIES GN 2/3<br>STACKING KIT | <table border="1"> <thead> <tr> <th>Code</th> <th>Description</th> <th>Qty</th> <th>UOM</th> </tr> </thead> <tbody> <tr> <td>0H6462A0</td> <td>XC756 FRONT<br/>PROFILE</td> <td>1</td> <td>PZ</td> </tr> <tr> <td>CE1305A0</td> <td>L=2MT RJ45 -<br/>RJ45 CABLE</td> <td>1</td> <td>PZ</td> </tr> <tr> <td>ED1246A0</td> <td>HOT SURFACE<br/>LABEL</td> <td>1</td> <td>PZ</td> </tr> <tr> <td>ED1271A0</td> <td>LIQUID FALLS<br/>DANGER LABE</td> <td>1</td> <td>PZ</td> </tr> </tbody> </table> | Code | Description | Qty | UOM | 0H6462A0 | XC756 FRONT<br>PROFILE | 1 | PZ | CE1305A0 | L=2MT RJ45 -<br>RJ45 CABLE | 1 | PZ | ED1246A0 | HOT SURFACE<br>LABEL | 1 | PZ | ED1271A0 | LIQUID FALLS<br>DANGER LABE | 1 | PZ |
|           |  |   | Code       | Description                       | Qty  | UOM  |             |     |     |          |   |   |   |          |   |   |    |          |              |       |   |          |                                      |   |    |          |  |   |    |          |                                |   |    |          |  |    |    |          |             |   |    |          |                 |   |    |          |   |   |    |          |   |   |    |          |   |   |    |          |                             |   |    |          |                                  |   |    |          |                       |   |    |       |                                 |  |      |             |     |     |          |                        |   |    |          |                            |   |    |          |                      |   |    |          |                             |   |    |
| TB1520A0  | INT. Ø=38<br>TH=4 DRAIN<br>BLACK<br>RUBBER PIPE    | 5   | M          |                                   |  |      |             |     |     |          |   |   |   |          |   |   |    |          |              |       |   |          |                                      |   |    |          |  |   |    |          |                                |   |    |          |  |    |    |          |             |   |    |          |                 |   |    |          |   |   |    |          |   |   |    |          |   |   |    |          |                             |   |    |          |                                  |   |    |          |                       |   |    |       |                                 |  |      |             |     |     |          |                        |   |    |          |                            |   |    |          |                      |   |    |          |                             |   |    |
| TB1765A1  | STACKING KIT<br>CHIMNEY<br>CONNECTING<br>PIPE      | 2   | PZ         |                                   |  |      |             |     |     |          |   |   |   |          |   |   |    |          |              |       |   |          |                                      |   |    |          |  |   |    |          |                                |   |    |          |  |    |    |          |             |   |    |          |                 |   |    |          |   |   |    |          |   |   |    |          |   |   |    |          |                             |   |    |          |                                  |   |    |          |                       |   |    |       |                                 |  |      |             |     |     |          |                        |   |    |          |                            |   |    |          |                      |   |    |          |                             |   |    |
| TB2243A0  | Ø10 PET PIPE                                       | 1.500   | M          |                                   |  |      |             |     |     |          |   |   |   |          |   |   |    |          |              |       |   |          |                                      |   |    |          |  |   |    |          |                                |   |    |          |  |    |    |          |             |   |    |          |                 |   |    |          |   |   |    |          |   |   |    |          |   |   |    |          |                             |   |    |          |                                  |   |    |          |                       |   |    |       |                                 |  |      |             |     |     |          |                        |   |    |          |                            |   |    |          |                      |   |    |          |                             |   |    |
| VI1220A1  | 4,2X12 TCB<br>SELF-TAPPIN<br>G SCREW               | 4   | PZ         |                                   |  |      |             |     |     |          |   |   |   |          |   |   |    |          |              |       |   |          |                                      |   |    |          |  |   |    |          |                                |   |    |          |  |    |    |          |             |   |    |          |                 |   |    |          |   |   |    |          |   |   |    |          |   |   |    |          |                             |   |    |          |                                  |   |    |          |                       |   |    |       |                                 |  |      |             |     |     |          |                        |   |    |          |                            |   |    |          |                      |   |    |          |                             |   |    |
| VI1895A0  | BLIND NUT M4<br>STAINLESS<br>STEEL DIN 917         | 8   | PZ         |                                   |  |      |             |     |     |          |   |   |   |          |   |   |    |          |              |       |   |          |                                      |   |    |          |  |   |    |          |                                |   |    |          |  |    |    |          |             |   |    |          |                 |   |    |          |   |   |    |          |   |   |    |          |   |   |    |          |                             |   |    |          |                                  |   |    |          |                       |   |    |       |                                 |  |      |             |     |     |          |                        |   |    |          |                            |   |    |          |                      |   |    |          |                             |   |    |
| VI1945A0  | ENG-VITE<br>M4X20 TCB+<br>INOX                     | 8   | PZ         |                                   |  |      |             |     |     |          |   |   |   |          |   |   |    |          |              |       |   |          |                                      |   |    |          |  |   |    |          |                                |   |    |          |  |    |    |          |             |   |    |          |                 |   |    |          |   |   |    |          |   |   |    |          |   |   |    |          |                             |   |    |          |                                  |   |    |          |                       |   |    |       |                                 |  |      |             |     |     |          |                        |   |    |          |                            |   |    |          |                      |   |    |          |                             |   |    |
| VI1950A0  | ST. STEEL<br>4,2X13 TCB<br>SELF-DRILLIN<br>G SCREW | 26  | PZ         |                                   |  |      |             |     |     |          |   |   |   |          |   |   |    |          |              |       |   |          |                                      |   |    |          |  |   |    |          |                                |   |    |          |  |    |    |          |             |   |    |          |                 |   |    |          |   |   |    |          |   |   |    |          |   |   |    |          |                             |   |    |          |                                  |   |    |          |                       |   |    |       |                                 |  |      |             |     |     |          |                        |   |    |          |                            |   |    |          |                      |   |    |          |                             |   |    |
| VL1005A1  | U-TRAP TANK  | 2   | PZ         |                                   |  |      |             |     |     |          |   |   |   |          |   |   |    |          |              |       |   |          |                                      |   |    |          |  |   |    |          |                                |   |    |          |  |    |    |          |             |   |    |          |                 |   |    |          |   |   |    |          |   |   |    |          |   |   |    |          |                             |   |    |          |                                  |   |    |          |                       |   |    |       |                                 |  |      |             |     |     |          |                        |   |    |          |                            |   |    |          |                      |   |    |          |                             |   |    |
| VL1006A0  | SYPHON<br>COVER                                    | 2   | PZ         |                                   |  |      |             |     |     |          |   |   |   |          |   |   |    |          |              |       |   |          |                                      |   |    |          |  |   |    |          |                                |   |    |          |  |    |    |          |             |   |    |          |                 |   |    |          |   |   |    |          |   |   |    |          |   |   |    |          |                             |   |    |          |                                  |   |    |          |                       |   |    |       |                                 |  |      |             |     |     |          |                        |   |    |          |                            |   |    |          |                      |   |    |          |                             |   |    |
| VL1043A0  | D4 PIPE<br>HOLDER - D6<br>J.G. TERMINAL            | 3   | PZ         |                                   |  |      |             |     |     |          |   |   |   |          |   |   |    |          |              |       |   |          |                                      |   |    |          |  |   |    |          |                                |   |    |          |  |    |    |          |             |   |    |          |                 |   |    |          |   |   |    |          |   |   |    |          |   |   |    |          |                             |   |    |          |                                  |   |    |          |                       |   |    |       |                                 |  |      |             |     |     |          |                        |   |    |          |                            |   |    |          |                      |   |    |          |                             |   |    |
| VL1046A1  | D6 PIPE<br>HOLDER - D6<br>J.G. TERMINAL            | 3   | PZ         |                                   |  |      |             |     |     |          |   |   |   |          |   |   |    |          |              |       |   |          |                                      |   |    |          |  |   |    |          |                                |   |    |          |  |    |    |          |             |   |    |          |                 |   |    |          |   |   |    |          |   |   |    |          |   |   |    |          |                             |   |    |          |                                  |   |    |          |                       |   |    |       |                                 |  |      |             |     |     |          |                        |   |    |          |                            |   |    |          |                      |   |    |          |                             |   |    |
| VM1015A1  | STAINLESS<br>STEEL<br>Ø30X1.5 90°<br>BEND          | 1   | PZ         |                                   |  |      |             |     |     |          |   |   |   |          |   |   |    |          |              |       |   |          |                                      |   |    |          |  |   |    |          |                                |   |    |          |  |    |    |          |             |   |    |          |                 |   |    |          |   |   |    |          |   |   |    |          |   |   |    |          |                             |   |    |          |                                  |   |    |          |                       |   |    |       |                                 |  |      |             |     |     |          |                        |   |    |          |                            |   |    |          |                      |   |    |          |                             |   |    |
| VM1794A0  | 250X4.8 PA66<br>BLACK CLAMP                        | 3   | PZ         |                                   |  |      |             |     |     |          |   |   |   |          |   |   |    |          |              |       |   |          |                                      |   |    |          |  |   |    |          |                                |   |    |          |  |    |    |          |             |   |    |          |                 |   |    |          |   |   |    |          |   |   |    |          |   |   |    |          |                             |   |    |          |                                  |   |    |          |                       |   |    |       |                                 |  |      |             |     |     |          |                        |   |    |          |                            |   |    |          |                      |   |    |          |                             |   |    |
| VM1987A0  | BRACKET FOR<br>OVENS<br>STACKING                   | 1   | PZ         |                                   |  |      |             |     |     |          |   |   |   |          |   |   |    |          |              |       |   |          |                                      |   |    |          |  |   |    |          |                                |   |    |          |  |    |    |          |             |   |    |          |                 |   |    |          |   |   |    |          |   |   |    |          |   |   |    |          |                             |   |    |          |                                  |   |    |          |                       |   |    |       |                                 |  |      |             |     |     |          |                        |   |    |          |                            |   |    |          |                      |   |    |          |                             |   |    |
| VM2035A0  | DRAIN PIPE<br>SUPPORT                              | 2   | PZ         |                                   |  |      |             |     |     |          |   |   |   |          |   |   |    |          |              |       |   |          |                                      |   |    |          |  |   |    |          |                                |   |    |          |  |    |    |          |             |   |    |          |                 |   |    |          |   |   |    |          |   |   |    |          |   |   |    |          |                             |   |    |          |                                  |   |    |          |                       |   |    |       |                                 |  |      |             |     |     |          |                        |   |    |          |                            |   |    |          |                      |   |    |          |                             |   |    |
| Code      | Description  | Qty   | UOM        |                                   |  |      |             |     |     |          |   |   |   |          |   |   |    |          |              |       |   |          |                                      |   |    |          |  |   |    |          |                                |   |    |          |  |    |    |          |             |   |    |          |                 |   |    |          |   |   |    |          |   |   |    |          |   |   |    |          |                             |   |    |          |                                  |   |    |          |                       |   |    |       |                                 |  |      |             |     |     |          |                        |   |    |          |                            |   |    |          |                      |   |    |          |                             |   |    |
| 0H6462A0  | XC756 FRONT<br>PROFILE                             | 1   | PZ         |                                   |  |      |             |     |     |          |   |   |   |          |   |   |    |          |              |       |   |          |                                      |   |    |          |  |   |    |          |                                |   |    |          |  |    |    |          |             |   |    |          |                 |   |    |          |   |   |    |          |   |   |    |          |   |   |    |          |                             |   |    |          |                                  |   |    |          |                       |   |    |       |                                 |  |      |             |     |     |          |                        |   |    |          |                            |   |    |          |                      |   |    |          |                             |   |    |
| CE1305A0  | L=2MT RJ45 -<br>RJ45 CABLE                         | 1   | PZ         |                                   |  |      |             |     |     |          |   |   |   |          |   |   |    |          |              |       |   |          |                                      |   |    |          |  |   |    |          |                                |   |    |          |  |    |    |          |             |   |    |          |                 |   |    |          |   |   |    |          |   |   |    |          |   |   |    |          |                             |   |    |          |                                  |   |    |          |                       |   |    |       |                                 |  |      |             |     |     |          |                        |   |    |          |                            |   |    |          |                      |   |    |          |                             |   |    |
| ED1246A0  | HOT SURFACE<br>LABEL                               | 1   | PZ         |                                   |  |      |             |     |     |          |   |   |   |          |   |   |    |          |              |       |   |          |                                      |   |    |          |  |   |    |          |                                |   |    |          |  |    |    |          |             |   |    |          |                 |   |    |          |   |   |    |          |   |   |    |          |   |   |    |          |                             |   |    |          |                                  |   |    |          |                       |   |    |       |                                 |  |      |             |     |     |          |                        |   |    |          |                            |   |    |          |                      |   |    |          |                             |   |    |
| ED1271A0  | LIQUID FALLS<br>DANGER LABE                        | 1   | PZ         |                                   |  |      |             |     |     |          |   |   |   |          |   |   |    |          |              |       |   |          |                                      |   |    |          |  |   |    |          |                                |   |    |          |  |    |    |          |             |   |    |          |                 |   |    |          |   |   |    |          |   |   |    |          |   |   |    |          |                             |   |    |          |                                  |   |    |          |                       |   |    |       |                                 |  |      |             |     |     |          |                        |   |    |          |                            |   |    |          |                      |   |    |          |                             |   |    |

| COMPONENT |  |   | SPARE PART |                                 |  |      |             |     |     |          |  |   |    |          |                              |   |    |          |                               |   |    |          |                    |   |    |          |   |    |    |          |              |   |    |          |                         |   |    |          |              |   |    |          |   |   |   |          |   |   |    |          |              |       |   |          |                                      |   |    |          |  |   |    |          |                                |   |    |          |  |    |    |          |             |   |    |          |                 |   |    |          |   |   |    |          |   |   |    |          |   |   |    |
|-----------|--|---|------------|---------------------------------|--|------|-------------|-----|-----|----------|--|---|----|----------|------------------------------|---|----|----------|-------------------------------|---|----|----------|--------------------|---|----|----------|---|----|----|----------|--------------|---|----|----------|-------------------------|---|----|----------|--------------|---|----|----------|---|---|---|----------|---|---|----|----------|--------------|-------|---|----------|--------------------------------------|---|----|----------|--|---|----|----------|--------------------------------|---|----|----------|--|----|----|----------|-------------|---|----|----------|-----------------|---|----|----------|---|---|----|----------|---|---|----|----------|---|---|----|
| Code      | Description  | Image   | Code       | Description                     | Components list  |      |             |     |     |          |  |   |    |          |                              |   |    |          |                               |   |    |          |                    |   |    |          |   |    |    |          |              |   |    |          |                         |   |    |          |              |   |    |          |   |   |   |          |   |   |    |          |              |       |   |          |                                      |   |    |          |  |   |    |          |                                |   |    |          |  |    |    |          |             |   |    |          |                 |   |    |          |   |   |    |          |   |   |    |          |   |   |    |
| VL1005A   | U-TRAP TANK  |  | XC756      | E SERIES GN 2/3<br>STACKING KIT | <table border="1"> <thead> <tr> <th>Code</th> <th>Description</th> <th>Qty</th> <th>UOM</th> </tr> </thead> <tbody> <tr> <td>EL1020A1</td> <td>D8<br/>INTERMEDIAT<br/>E T-SHAPED<br/>FITTING</td> <td>2</td> <td>PZ</td> </tr> <tr> <td>GN1508A0</td> <td>O-RING<br/>GASKET COD<br/>2400</td> <td>2</td> <td>PZ</td> </tr> <tr> <td>PD1069A0</td> <td>FOOT<br/>OVERLAP S5<br/>CT-BT-E</td> <td>1</td> <td>PZ</td> </tr> <tr> <td>RC1008A0</td> <td>D9 ELASTIC<br/>CLIP</td> <td>3</td> <td>PZ</td> </tr> <tr> <td>RC1055A0</td> <td>Ø25-40 H12<br/>STAINLESS<br/>STEEL PIPE<br/>CLIP</td> <td>14</td> <td>PZ</td> </tr> <tr> <td>RC1130A0</td> <td>130X2,6 CLAM</td> <td>3</td> <td>PZ</td> </tr> <tr> <td>RC1297A1</td> <td>D10 T-SHAPED<br/>FITTING</td> <td>1</td> <td>PZ</td> </tr> <tr> <td>RC1376A0</td> <td>Ø6 Y-FITTING</td> <td>1</td> <td>PZ</td> </tr> <tr> <td>TB1520A0</td> <td>INT. Ø=38<br/>TH=4 DRAIN<br/>BLACK<br/>RUBBER PIPE</td> <td>3</td> <td>M</td> </tr> <tr> <td>TB1765A1</td> <td>STACKING KIT<br/>CHIMNEY<br/>CONNECTING<br/>PIPE</td> <td>1</td> <td>PZ</td> </tr> <tr> <td>TB2243A0</td> <td>Ø10 PET PIPE</td> <td>1.500</td> <td>M</td> </tr> <tr> <td>VI1220A1</td> <td>4,2X12 TCB<br/>SELF-TAPPIN<br/>G SCREW</td> <td>4</td> <td>PZ</td> </tr> <tr> <td>VI1895A0</td> <td>BLIND NUT M4<br/>STAINLESS<br/>STEEL DIN 917</td> <td>8</td> <td>PZ</td> </tr> <tr> <td>VI1945A0</td> <td>ENG-VITE<br/>M4X20 TCB+<br/>INOX</td> <td>8</td> <td>PZ</td> </tr> <tr> <td>VI1950A0</td> <td>ST. STEEL<br/>4,2X13 TCB<br/>SELF-DRILLIN<br/>G SCREW</td> <td>26</td> <td>PZ</td> </tr> <tr> <td>VL1005A1</td> <td>U-TRAP TANK</td> <td>2</td> <td>PZ</td> </tr> <tr> <td>VL1006A0</td> <td>SYPHON<br/>COVER</td> <td>2</td> <td>PZ</td> </tr> <tr> <td>VL1043A0</td> <td>D4 PIPE<br/>HOLDER - D6<br/>J.G. TERMINAL</td> <td>3</td> <td>PZ</td> </tr> <tr> <td>VL1046A1</td> <td>D6 PIPE<br/>HOLDER - D6<br/>J.G. TERMINAL</td> <td>3</td> <td>PZ</td> </tr> <tr> <td>VM1015A1</td> <td>STAINLESS<br/>STEEL<br/>Ø30X1,5 90°<br/>BEND</td> <td>1</td> <td>PZ</td> </tr> </tbody> </table> | Code | Description | Qty | UOM | EL1020A1 | D8<br>INTERMEDIAT<br>E T-SHAPED<br>FITTING | 2 | PZ | GN1508A0 | O-RING<br>GASKET COD<br>2400 | 2 | PZ | PD1069A0 | FOOT<br>OVERLAP S5<br>CT-BT-E | 1 | PZ | RC1008A0 | D9 ELASTIC<br>CLIP | 3 | PZ | RC1055A0 | Ø25-40 H12<br>STAINLESS<br>STEEL PIPE<br>CLIP | 14 | PZ | RC1130A0 | 130X2,6 CLAM | 3 | PZ | RC1297A1 | D10 T-SHAPED<br>FITTING | 1 | PZ | RC1376A0 | Ø6 Y-FITTING | 1 | PZ | TB1520A0 | INT. Ø=38<br>TH=4 DRAIN<br>BLACK<br>RUBBER PIPE | 3 | M | TB1765A1 | STACKING KIT<br>CHIMNEY<br>CONNECTING<br>PIPE | 1 | PZ | TB2243A0 | Ø10 PET PIPE | 1.500 | M | VI1220A1 | 4,2X12 TCB<br>SELF-TAPPIN<br>G SCREW | 4 | PZ | VI1895A0 | BLIND NUT M4<br>STAINLESS<br>STEEL DIN 917 | 8 | PZ | VI1945A0 | ENG-VITE<br>M4X20 TCB+<br>INOX | 8 | PZ | VI1950A0 | ST. STEEL<br>4,2X13 TCB<br>SELF-DRILLIN<br>G SCREW | 26 | PZ | VL1005A1 | U-TRAP TANK | 2 | PZ | VL1006A0 | SYPHON<br>COVER | 2 | PZ | VL1043A0 | D4 PIPE<br>HOLDER - D6<br>J.G. TERMINAL | 3 | PZ | VL1046A1 | D6 PIPE<br>HOLDER - D6<br>J.G. TERMINAL | 3 | PZ | VM1015A1 | STAINLESS<br>STEEL<br>Ø30X1,5 90°<br>BEND | 1 | PZ |
| Code      | Description  | Qty   | UOM        |                                 |  |      |             |     |     |          |  |   |    |          |                              |   |    |          |                               |   |    |          |                    |   |    |          |   |    |    |          |              |   |    |          |                         |   |    |          |              |   |    |          |   |   |   |          |   |   |    |          |              |       |   |          |                                      |   |    |          |  |   |    |          |                                |   |    |          |  |    |    |          |             |   |    |          |                 |   |    |          |   |   |    |          |   |   |    |          |   |   |    |
| EL1020A1  | D8<br>INTERMEDIAT<br>E T-SHAPED<br>FITTING         | 2   | PZ         |                                 |  |      |             |     |     |          |  |   |    |          |                              |   |    |          |                               |   |    |          |                    |   |    |          |   |    |    |          |              |   |    |          |                         |   |    |          |              |   |    |          |   |   |   |          |   |   |    |          |              |       |   |          |                                      |   |    |          |  |   |    |          |                                |   |    |          |  |    |    |          |             |   |    |          |                 |   |    |          |   |   |    |          |   |   |    |          |   |   |    |
| GN1508A0  | O-RING<br>GASKET COD<br>2400                       | 2   | PZ         |                                 |  |      |             |     |     |          |  |   |    |          |                              |   |    |          |                               |   |    |          |                    |   |    |          |   |    |    |          |              |   |    |          |                         |   |    |          |              |   |    |          |   |   |   |          |   |   |    |          |              |       |   |          |                                      |   |    |          |  |   |    |          |                                |   |    |          |  |    |    |          |             |   |    |          |                 |   |    |          |   |   |    |          |   |   |    |          |   |   |    |
| PD1069A0  | FOOT<br>OVERLAP S5<br>CT-BT-E                      | 1   | PZ         |                                 |  |      |             |     |     |          |  |   |    |          |                              |   |    |          |                               |   |    |          |                    |   |    |          |   |    |    |          |              |   |    |          |                         |   |    |          |              |   |    |          |   |   |   |          |   |   |    |          |              |       |   |          |                                      |   |    |          |  |   |    |          |                                |   |    |          |  |    |    |          |             |   |    |          |                 |   |    |          |   |   |    |          |   |   |    |          |   |   |    |
| RC1008A0  | D9 ELASTIC<br>CLIP                                 | 3   | PZ         |                                 |  |      |             |     |     |          |  |   |    |          |                              |   |    |          |                               |   |    |          |                    |   |    |          |   |    |    |          |              |   |    |          |                         |   |    |          |              |   |    |          |   |   |   |          |   |   |    |          |              |       |   |          |                                      |   |    |          |  |   |    |          |                                |   |    |          |  |    |    |          |             |   |    |          |                 |   |    |          |   |   |    |          |   |   |    |          |   |   |    |
| RC1055A0  | Ø25-40 H12<br>STAINLESS<br>STEEL PIPE<br>CLIP      | 14  | PZ         |                                 |  |      |             |     |     |          |  |   |    |          |                              |   |    |          |                               |   |    |          |                    |   |    |          |   |    |    |          |              |   |    |          |                         |   |    |          |              |   |    |          |   |   |   |          |   |   |    |          |              |       |   |          |                                      |   |    |          |  |   |    |          |                                |   |    |          |  |    |    |          |             |   |    |          |                 |   |    |          |   |   |    |          |   |   |    |          |   |   |    |
| RC1130A0  | 130X2,6 CLAM                                       | 3   | PZ         |                                 |  |      |             |     |     |          |  |   |    |          |                              |   |    |          |                               |   |    |          |                    |   |    |          |   |    |    |          |              |   |    |          |                         |   |    |          |              |   |    |          |   |   |   |          |   |   |    |          |              |       |   |          |                                      |   |    |          |  |   |    |          |                                |   |    |          |  |    |    |          |             |   |    |          |                 |   |    |          |   |   |    |          |   |   |    |          |   |   |    |
| RC1297A1  | D10 T-SHAPED<br>FITTING                            | 1   | PZ         |                                 |  |      |             |     |     |          |  |   |    |          |                              |   |    |          |                               |   |    |          |                    |   |    |          |   |    |    |          |              |   |    |          |                         |   |    |          |              |   |    |          |   |   |   |          |   |   |    |          |              |       |   |          |                                      |   |    |          |  |   |    |          |                                |   |    |          |  |    |    |          |             |   |    |          |                 |   |    |          |   |   |    |          |   |   |    |          |   |   |    |
| RC1376A0  | Ø6 Y-FITTING                                       | 1   | PZ         |                                 |  |      |             |     |     |          |  |   |    |          |                              |   |    |          |                               |   |    |          |                    |   |    |          |   |    |    |          |              |   |    |          |                         |   |    |          |              |   |    |          |   |   |   |          |   |   |    |          |              |       |   |          |                                      |   |    |          |  |   |    |          |                                |   |    |          |  |    |    |          |             |   |    |          |                 |   |    |          |   |   |    |          |   |   |    |          |   |   |    |
| TB1520A0  | INT. Ø=38<br>TH=4 DRAIN<br>BLACK<br>RUBBER PIPE    | 3   | M          |                                 |  |      |             |     |     |          |  |   |    |          |                              |   |    |          |                               |   |    |          |                    |   |    |          |   |    |    |          |              |   |    |          |                         |   |    |          |              |   |    |          |   |   |   |          |   |   |    |          |              |       |   |          |                                      |   |    |          |  |   |    |          |                                |   |    |          |  |    |    |          |             |   |    |          |                 |   |    |          |   |   |    |          |   |   |    |          |   |   |    |
| TB1765A1  | STACKING KIT<br>CHIMNEY<br>CONNECTING<br>PIPE      | 1   | PZ         |                                 |  |      |             |     |     |          |  |   |    |          |                              |   |    |          |                               |   |    |          |                    |   |    |          |   |    |    |          |              |   |    |          |                         |   |    |          |              |   |    |          |   |   |   |          |   |   |    |          |              |       |   |          |                                      |   |    |          |  |   |    |          |                                |   |    |          |  |    |    |          |             |   |    |          |                 |   |    |          |   |   |    |          |   |   |    |          |   |   |    |
| TB2243A0  | Ø10 PET PIPE                                       | 1.500   | M          |                                 |  |      |             |     |     |          |  |   |    |          |                              |   |    |          |                               |   |    |          |                    |   |    |          |   |    |    |          |              |   |    |          |                         |   |    |          |              |   |    |          |   |   |   |          |   |   |    |          |              |       |   |          |                                      |   |    |          |  |   |    |          |                                |   |    |          |  |    |    |          |             |   |    |          |                 |   |    |          |   |   |    |          |   |   |    |          |   |   |    |
| VI1220A1  | 4,2X12 TCB<br>SELF-TAPPIN<br>G SCREW               | 4   | PZ         |                                 |  |      |             |     |     |          |  |   |    |          |                              |   |    |          |                               |   |    |          |                    |   |    |          |   |    |    |          |              |   |    |          |                         |   |    |          |              |   |    |          |   |   |   |          |   |   |    |          |              |       |   |          |                                      |   |    |          |  |   |    |          |                                |   |    |          |  |    |    |          |             |   |    |          |                 |   |    |          |   |   |    |          |   |   |    |          |   |   |    |
| VI1895A0  | BLIND NUT M4<br>STAINLESS<br>STEEL DIN 917         | 8   | PZ         |                                 |  |      |             |     |     |          |  |   |    |          |                              |   |    |          |                               |   |    |          |                    |   |    |          |   |    |    |          |              |   |    |          |                         |   |    |          |              |   |    |          |   |   |   |          |   |   |    |          |              |       |   |          |                                      |   |    |          |  |   |    |          |                                |   |    |          |  |    |    |          |             |   |    |          |                 |   |    |          |   |   |    |          |   |   |    |          |   |   |    |
| VI1945A0  | ENG-VITE<br>M4X20 TCB+<br>INOX                     | 8   | PZ         |                                 |  |      |             |     |     |          |  |   |    |          |                              |   |    |          |                               |   |    |          |                    |   |    |          |   |    |    |          |              |   |    |          |                         |   |    |          |              |   |    |          |   |   |   |          |   |   |    |          |              |       |   |          |                                      |   |    |          |  |   |    |          |                                |   |    |          |  |    |    |          |             |   |    |          |                 |   |    |          |   |   |    |          |   |   |    |          |   |   |    |
| VI1950A0  | ST. STEEL<br>4,2X13 TCB<br>SELF-DRILLIN<br>G SCREW | 26  | PZ         |                                 |  |      |             |     |     |          |  |   |    |          |                              |   |    |          |                               |   |    |          |                    |   |    |          |   |    |    |          |              |   |    |          |                         |   |    |          |              |   |    |          |   |   |   |          |   |   |    |          |              |       |   |          |                                      |   |    |          |  |   |    |          |                                |   |    |          |  |    |    |          |             |   |    |          |                 |   |    |          |   |   |    |          |   |   |    |          |   |   |    |
| VL1005A1  | U-TRAP TANK  | 2   | PZ         |                                 |  |      |             |     |     |          |  |   |    |          |                              |   |    |          |                               |   |    |          |                    |   |    |          |   |    |    |          |              |   |    |          |                         |   |    |          |              |   |    |          |   |   |   |          |   |   |    |          |              |       |   |          |                                      |   |    |          |  |   |    |          |                                |   |    |          |  |    |    |          |             |   |    |          |                 |   |    |          |   |   |    |          |   |   |    |          |   |   |    |
| VL1006A0  | SYPHON<br>COVER                                    | 2   | PZ         |                                 |  |      |             |     |     |          |  |   |    |          |                              |   |    |          |                               |   |    |          |                    |   |    |          |   |    |    |          |              |   |    |          |                         |   |    |          |              |   |    |          |   |   |   |          |   |   |    |          |              |       |   |          |                                      |   |    |          |  |   |    |          |                                |   |    |          |  |    |    |          |             |   |    |          |                 |   |    |          |   |   |    |          |   |   |    |          |   |   |    |
| VL1043A0  | D4 PIPE<br>HOLDER - D6<br>J.G. TERMINAL            | 3   | PZ         |                                 |  |      |             |     |     |          |  |   |    |          |                              |   |    |          |                               |   |    |          |                    |   |    |          |   |    |    |          |              |   |    |          |                         |   |    |          |              |   |    |          |   |   |   |          |   |   |    |          |              |       |   |          |                                      |   |    |          |  |   |    |          |                                |   |    |          |  |    |    |          |             |   |    |          |                 |   |    |          |   |   |    |          |   |   |    |          |   |   |    |
| VL1046A1  | D6 PIPE<br>HOLDER - D6<br>J.G. TERMINAL            | 3   | PZ         |                                 |  |      |             |     |     |          |  |   |    |          |                              |   |    |          |                               |   |    |          |                    |   |    |          |   |    |    |          |              |   |    |          |                         |   |    |          |              |   |    |          |   |   |   |          |   |   |    |          |              |       |   |          |                                      |   |    |          |  |   |    |          |                                |   |    |          |  |    |    |          |             |   |    |          |                 |   |    |          |   |   |    |          |   |   |    |          |   |   |    |
| VM1015A1  | STAINLESS<br>STEEL<br>Ø30X1,5 90°<br>BEND          | 1   | PZ         |                                 |  |      |             |     |     |          |  |   |    |          |                              |   |    |          |                               |   |    |          |                    |   |    |          |   |    |    |          |              |   |    |          |                         |   |    |          |              |   |    |          |   |   |   |          |   |   |    |          |              |       |   |          |                                      |   |    |          |  |   |    |          |                                |   |    |          |  |    |    |          |             |   |    |          |                 |   |    |          |   |   |    |          |   |   |    |          |   |   |    |



| COMPONENT |   |   | SPARE PART |                                 |   |      |             |                        |     |          |                             |                           |    |          |                                  |                      |    |          |                       |                             |    |    |          |  |   |    |          |                              |   |    |          |                               |   |    |          |                    |   |    |          |   |    |    |          |              |   |    |          |                         |   |    |          |              |   |    |          |   |   |   |          |   |   |    |          |              |       |   |          |                                      |   |    |          |  |   |    |          |                                |   |    |
|-----------|---|---|------------|---------------------------------|---|------|-------------|------------------------|-----|----------|-----------------------------|---------------------------|----|----------|----------------------------------|----------------------|----|----------|-----------------------|-----------------------------|----|----|----------|--|---|----|----------|------------------------------|---|----|----------|-------------------------------|---|----|----------|--------------------|---|----|----------|---|----|----|----------|--------------|---|----|----------|-------------------------|---|----|----------|--------------|---|----|----------|---|---|---|----------|---|---|----|----------|--------------|-------|---|----------|--------------------------------------|---|----|----------|--|---|----|----------|--------------------------------|---|----|
| Code      | Description                                     | Image   | Code       | Description                     | Components list   |      |             |                        |     |          |                             |                           |    |          |                                  |                      |    |          |                       |                             |    |    |          |  |   |    |          |                              |   |    |          |                               |   |    |          |                    |   |    |          |   |    |    |          |              |   |    |          |                         |   |    |          |              |   |    |          |   |   |   |          |   |   |    |          |              |       |   |          |                                      |   |    |          |  |   |    |          |                                |   |    |
| VL1005A   | U-TRAP TANK                                     |    | XC756      | E SERIES GN 2/3<br>STACKING KIT | <table border="1"> <thead> <tr> <th>Code</th> <th>Description</th> <th>Qty</th> <th>UOM</th> </tr> </thead> <tbody> <tr> <td>VM1794A0</td> <td>250X4.8 PA66<br/>BLACK CLAMP</td> <td>3</td> <td>PZ</td> </tr> <tr> <td>VM1987A0</td> <td>BRACKET FOR<br/>OVENS<br/>STACKING</td> <td>1</td> <td>PZ</td> </tr> <tr> <td>VM2035A0</td> <td>DRAIN PIPE<br/>SUPPORT</td> <td>1</td> <td>PZ</td> </tr> </tbody> </table> | Code | Description | Qty                    | UOM | VM1794A0 | 250X4.8 PA66<br>BLACK CLAMP | 3                         | PZ | VM1987A0 | BRACKET FOR<br>OVENS<br>STACKING | 1                    | PZ | VM2035A0 | DRAIN PIPE<br>SUPPORT | 1                           | PZ |    |          |  |   |    |          |                              |   |    |          |                               |   |    |          |                    |   |    |          |   |    |    |          |              |   |    |          |                         |   |    |          |              |   |    |          |   |   |   |          |   |   |    |          |              |       |   |          |                                      |   |    |          |  |   |    |          |                                |   |    |
|           |   |   | Code       | Description                     | Qty   | UOM  |             |                        |     |          |                             |                           |    |          |                                  |                      |    |          |                       |                             |    |    |          |  |   |    |          |                              |   |    |          |                               |   |    |          |                    |   |    |          |   |    |    |          |              |   |    |          |                         |   |    |          |              |   |    |          |   |   |   |          |   |   |    |          |              |       |   |          |                                      |   |    |          |  |   |    |          |                                |   |    |
| VM1794A0  | 250X4.8 PA66<br>BLACK CLAMP                     | 3   | PZ         |                                 |   |      |             |                        |     |          |                             |                           |    |          |                                  |                      |    |          |                       |                             |    |    |          |  |   |    |          |                              |   |    |          |                               |   |    |          |                    |   |    |          |   |    |    |          |              |   |    |          |                         |   |    |          |              |   |    |          |   |   |   |          |   |   |    |          |              |       |   |          |                                      |   |    |          |  |   |    |          |                                |   |    |
| VM1987A0  | BRACKET FOR<br>OVENS<br>STACKING                | 1   | PZ         |                                 |   |      |             |                        |     |          |                             |                           |    |          |                                  |                      |    |          |                       |                             |    |    |          |  |   |    |          |                              |   |    |          |                               |   |    |          |                    |   |    |          |   |    |    |          |              |   |    |          |                         |   |    |          |              |   |    |          |   |   |   |          |   |   |    |          |              |       |   |          |                                      |   |    |          |  |   |    |          |                                |   |    |
| VM2035A0  | DRAIN PIPE<br>SUPPORT                           | 1   | PZ         |                                 |   |      |             |                        |     |          |                             |                           |    |          |                                  |                      |    |          |                       |                             |    |    |          |  |   |    |          |                              |   |    |          |                               |   |    |          |                    |   |    |          |   |    |    |          |              |   |    |          |                         |   |    |          |              |   |    |          |   |   |   |          |   |   |    |          |              |       |   |          |                                      |   |    |          |  |   |    |          |                                |   |    |
| XC755     | E SERIES BT-CT GN<br>2/1 STACKING KIT           | <table border="1"> <thead> <tr> <th>Code</th> <th>Description</th> <th>Qty</th> <th>UOM</th> </tr> </thead> <tbody> <tr> <td>0H6461A0</td> <td>XC755 FRONT<br/>PROFILE</td> <td>1</td> <td>PZ</td> </tr> <tr> <td>CE1635A0</td> <td>RJ45 - RJ45<br/>CABLE L=3M</td> <td>1</td> <td>PZ</td> </tr> <tr> <td>ED1246A0</td> <td>HOT SURFACE<br/>LABEL</td> <td>2</td> <td>PZ</td> </tr> <tr> <td>ED1271A0</td> <td>LIQUID FALLS<br/>DANGER LABE</td> <td>1</td> <td>PZ</td> </tr> <tr> <td>EL1020A1</td> <td>D8<br/>INTERMEDIAT<br/>E T-SHAPED<br/>FITTING</td> <td>2</td> <td>PZ</td> </tr> <tr> <td>GN1508A0</td> <td>O-RING<br/>GASKET COD<br/>2400</td> <td>2</td> <td>PZ</td> </tr> <tr> <td>PD1069A0</td> <td>FOOT<br/>OVERLAP S5<br/>CT-BT-E</td> <td>1</td> <td>PZ</td> </tr> <tr> <td>RC1008A0</td> <td>D9 ELASTIC<br/>CLIP</td> <td>3</td> <td>PZ</td> </tr> <tr> <td>RC1055A0</td> <td>Ø25-40 H12<br/>STAINLESS<br/>STEEL PIPE<br/>CLIP</td> <td>14</td> <td>PZ</td> </tr> <tr> <td>RC1130A0</td> <td>130X2.6 CLAM</td> <td>3</td> <td>PZ</td> </tr> <tr> <td>RC1297A1</td> <td>D10 T-SHAPED<br/>FITTING</td> <td>1</td> <td>PZ</td> </tr> <tr> <td>RC1376A0</td> <td>Ø6 Y-FITTING</td> <td>1</td> <td>PZ</td> </tr> <tr> <td>TB1520A0</td> <td>INT. Ø=38<br/>TH=4 DRAIN<br/>BLACK<br/>RUBBER PIPE</td> <td>5</td> <td>M</td> </tr> <tr> <td>TB1765A1</td> <td>STACKING KIT<br/>CHIMNEY<br/>CONNECTING<br/>PIPE</td> <td>2</td> <td>PZ</td> </tr> <tr> <td>TB2243A0</td> <td>Ø10 PET PIPE</td> <td>1.500</td> <td>M</td> </tr> <tr> <td>VI1220A1</td> <td>4,2X12 TCB<br/>SELF-TAPPIN<br/>G SCREW</td> <td>4</td> <td>PZ</td> </tr> <tr> <td>VI1895A0</td> <td>BLIND NUT M4<br/>STAINLESS<br/>STEEL DIN 917</td> <td>8</td> <td>PZ</td> </tr> <tr> <td>VI1945A0</td> <td>ENG-VITE<br/>M4X20 TCB+<br/>INOX</td> <td>8</td> <td>PZ</td> </tr> </tbody> </table> | Code       | Description                     | Qty   | UOM  | 0H6461A0    | XC755 FRONT<br>PROFILE | 1   | PZ       | CE1635A0                    | RJ45 - RJ45<br>CABLE L=3M | 1  | PZ       | ED1246A0                         | HOT SURFACE<br>LABEL | 2  | PZ       | ED1271A0              | LIQUID FALLS<br>DANGER LABE | 1  | PZ | EL1020A1 | D8<br>INTERMEDIAT<br>E T-SHAPED<br>FITTING | 2 | PZ | GN1508A0 | O-RING<br>GASKET COD<br>2400 | 2 | PZ | PD1069A0 | FOOT<br>OVERLAP S5<br>CT-BT-E | 1 | PZ | RC1008A0 | D9 ELASTIC<br>CLIP | 3 | PZ | RC1055A0 | Ø25-40 H12<br>STAINLESS<br>STEEL PIPE<br>CLIP | 14 | PZ | RC1130A0 | 130X2.6 CLAM | 3 | PZ | RC1297A1 | D10 T-SHAPED<br>FITTING | 1 | PZ | RC1376A0 | Ø6 Y-FITTING | 1 | PZ | TB1520A0 | INT. Ø=38<br>TH=4 DRAIN<br>BLACK<br>RUBBER PIPE | 5 | M | TB1765A1 | STACKING KIT<br>CHIMNEY<br>CONNECTING<br>PIPE | 2 | PZ | TB2243A0 | Ø10 PET PIPE | 1.500 | M | VI1220A1 | 4,2X12 TCB<br>SELF-TAPPIN<br>G SCREW | 4 | PZ | VI1895A0 | BLIND NUT M4<br>STAINLESS<br>STEEL DIN 917 | 8 | PZ | VI1945A0 | ENG-VITE<br>M4X20 TCB+<br>INOX | 8 | PZ |
| Code      | Description                                     | Qty   | UOM        |                                 |   |      |             |                        |     |          |                             |                           |    |          |                                  |                      |    |          |                       |                             |    |    |          |  |   |    |          |                              |   |    |          |                               |   |    |          |                    |   |    |          |   |    |    |          |              |   |    |          |                         |   |    |          |              |   |    |          |   |   |   |          |   |   |    |          |              |       |   |          |                                      |   |    |          |  |   |    |          |                                |   |    |
| 0H6461A0  | XC755 FRONT<br>PROFILE                          | 1   | PZ         |                                 |   |      |             |                        |     |          |                             |                           |    |          |                                  |                      |    |          |                       |                             |    |    |          |  |   |    |          |                              |   |    |          |                               |   |    |          |                    |   |    |          |   |    |    |          |              |   |    |          |                         |   |    |          |              |   |    |          |   |   |   |          |   |   |    |          |              |       |   |          |                                      |   |    |          |  |   |    |          |                                |   |    |
| CE1635A0  | RJ45 - RJ45<br>CABLE L=3M                       | 1   | PZ         |                                 |   |      |             |                        |     |          |                             |                           |    |          |                                  |                      |    |          |                       |                             |    |    |          |  |   |    |          |                              |   |    |          |                               |   |    |          |                    |   |    |          |   |    |    |          |              |   |    |          |                         |   |    |          |              |   |    |          |   |   |   |          |   |   |    |          |              |       |   |          |                                      |   |    |          |  |   |    |          |                                |   |    |
| ED1246A0  | HOT SURFACE<br>LABEL                            | 2   | PZ         |                                 |   |      |             |                        |     |          |                             |                           |    |          |                                  |                      |    |          |                       |                             |    |    |          |  |   |    |          |                              |   |    |          |                               |   |    |          |                    |   |    |          |   |    |    |          |              |   |    |          |                         |   |    |          |              |   |    |          |   |   |   |          |   |   |    |          |              |       |   |          |                                      |   |    |          |  |   |    |          |                                |   |    |
| ED1271A0  | LIQUID FALLS<br>DANGER LABE                     | 1   | PZ         |                                 |   |      |             |                        |     |          |                             |                           |    |          |                                  |                      |    |          |                       |                             |    |    |          |  |   |    |          |                              |   |    |          |                               |   |    |          |                    |   |    |          |   |    |    |          |              |   |    |          |                         |   |    |          |              |   |    |          |   |   |   |          |   |   |    |          |              |       |   |          |                                      |   |    |          |  |   |    |          |                                |   |    |
| EL1020A1  | D8<br>INTERMEDIAT<br>E T-SHAPED<br>FITTING      | 2   | PZ         |                                 |   |      |             |                        |     |          |                             |                           |    |          |                                  |                      |    |          |                       |                             |    |    |          |  |   |    |          |                              |   |    |          |                               |   |    |          |                    |   |    |          |   |    |    |          |              |   |    |          |                         |   |    |          |              |   |    |          |   |   |   |          |   |   |    |          |              |       |   |          |                                      |   |    |          |  |   |    |          |                                |   |    |
| GN1508A0  | O-RING<br>GASKET COD<br>2400                    | 2   | PZ         |                                 |   |      |             |                        |     |          |                             |                           |    |          |                                  |                      |    |          |                       |                             |    |    |          |  |   |    |          |                              |   |    |          |                               |   |    |          |                    |   |    |          |   |    |    |          |              |   |    |          |                         |   |    |          |              |   |    |          |   |   |   |          |   |   |    |          |              |       |   |          |                                      |   |    |          |  |   |    |          |                                |   |    |
| PD1069A0  | FOOT<br>OVERLAP S5<br>CT-BT-E                   | 1   | PZ         |                                 |   |      |             |                        |     |          |                             |                           |    |          |                                  |                      |    |          |                       |                             |    |    |          |  |   |    |          |                              |   |    |          |                               |   |    |          |                    |   |    |          |   |    |    |          |              |   |    |          |                         |   |    |          |              |   |    |          |   |   |   |          |   |   |    |          |              |       |   |          |                                      |   |    |          |  |   |    |          |                                |   |    |
| RC1008A0  | D9 ELASTIC<br>CLIP                              | 3   | PZ         |                                 |   |      |             |                        |     |          |                             |                           |    |          |                                  |                      |    |          |                       |                             |    |    |          |  |   |    |          |                              |   |    |          |                               |   |    |          |                    |   |    |          |   |    |    |          |              |   |    |          |                         |   |    |          |              |   |    |          |   |   |   |          |   |   |    |          |              |       |   |          |                                      |   |    |          |  |   |    |          |                                |   |    |
| RC1055A0  | Ø25-40 H12<br>STAINLESS<br>STEEL PIPE<br>CLIP   | 14  | PZ         |                                 |   |      |             |                        |     |          |                             |                           |    |          |                                  |                      |    |          |                       |                             |    |    |          |  |   |    |          |                              |   |    |          |                               |   |    |          |                    |   |    |          |   |    |    |          |              |   |    |          |                         |   |    |          |              |   |    |          |   |   |   |          |   |   |    |          |              |       |   |          |                                      |   |    |          |  |   |    |          |                                |   |    |
| RC1130A0  | 130X2.6 CLAM                                    | 3   | PZ         |                                 |   |      |             |                        |     |          |                             |                           |    |          |                                  |                      |    |          |                       |                             |    |    |          |  |   |    |          |                              |   |    |          |                               |   |    |          |                    |   |    |          |   |    |    |          |              |   |    |          |                         |   |    |          |              |   |    |          |   |   |   |          |   |   |    |          |              |       |   |          |                                      |   |    |          |  |   |    |          |                                |   |    |
| RC1297A1  | D10 T-SHAPED<br>FITTING                         | 1   | PZ         |                                 |   |      |             |                        |     |          |                             |                           |    |          |                                  |                      |    |          |                       |                             |    |    |          |  |   |    |          |                              |   |    |          |                               |   |    |          |                    |   |    |          |   |    |    |          |              |   |    |          |                         |   |    |          |              |   |    |          |   |   |   |          |   |   |    |          |              |       |   |          |                                      |   |    |          |  |   |    |          |                                |   |    |
| RC1376A0  | Ø6 Y-FITTING                                    | 1   | PZ         |                                 |   |      |             |                        |     |          |                             |                           |    |          |                                  |                      |    |          |                       |                             |    |    |          |  |   |    |          |                              |   |    |          |                               |   |    |          |                    |   |    |          |   |    |    |          |              |   |    |          |                         |   |    |          |              |   |    |          |   |   |   |          |   |   |    |          |              |       |   |          |                                      |   |    |          |  |   |    |          |                                |   |    |
| TB1520A0  | INT. Ø=38<br>TH=4 DRAIN<br>BLACK<br>RUBBER PIPE | 5   | M          |                                 |   |      |             |                        |     |          |                             |                           |    |          |                                  |                      |    |          |                       |                             |    |    |          |  |   |    |          |                              |   |    |          |                               |   |    |          |                    |   |    |          |   |    |    |          |              |   |    |          |                         |   |    |          |              |   |    |          |   |   |   |          |   |   |    |          |              |       |   |          |                                      |   |    |          |  |   |    |          |                                |   |    |
| TB1765A1  | STACKING KIT<br>CHIMNEY<br>CONNECTING<br>PIPE   | 2   | PZ         |                                 |   |      |             |                        |     |          |                             |                           |    |          |                                  |                      |    |          |                       |                             |    |    |          |  |   |    |          |                              |   |    |          |                               |   |    |          |                    |   |    |          |   |    |    |          |              |   |    |          |                         |   |    |          |              |   |    |          |   |   |   |          |   |   |    |          |              |       |   |          |                                      |   |    |          |  |   |    |          |                                |   |    |
| TB2243A0  | Ø10 PET PIPE                                    | 1.500   | M          |                                 |   |      |             |                        |     |          |                             |                           |    |          |                                  |                      |    |          |                       |                             |    |    |          |  |   |    |          |                              |   |    |          |                               |   |    |          |                    |   |    |          |   |    |    |          |              |   |    |          |                         |   |    |          |              |   |    |          |   |   |   |          |   |   |    |          |              |       |   |          |                                      |   |    |          |  |   |    |          |                                |   |    |
| VI1220A1  | 4,2X12 TCB<br>SELF-TAPPIN<br>G SCREW            | 4   | PZ         |                                 |   |      |             |                        |     |          |                             |                           |    |          |                                  |                      |    |          |                       |                             |    |    |          |  |   |    |          |                              |   |    |          |                               |   |    |          |                    |   |    |          |   |    |    |          |              |   |    |          |                         |   |    |          |              |   |    |          |   |   |   |          |   |   |    |          |              |       |   |          |                                      |   |    |          |  |   |    |          |                                |   |    |
| VI1895A0  | BLIND NUT M4<br>STAINLESS<br>STEEL DIN 917      | 8   | PZ         |                                 |   |      |             |                        |     |          |                             |                           |    |          |                                  |                      |    |          |                       |                             |    |    |          |  |   |    |          |                              |   |    |          |                               |   |    |          |                    |   |    |          |   |    |    |          |              |   |    |          |                         |   |    |          |              |   |    |          |   |   |   |          |   |   |    |          |              |       |   |          |                                      |   |    |          |  |   |    |          |                                |   |    |
| VI1945A0  | ENG-VITE<br>M4X20 TCB+<br>INOX                  | 8   | PZ         |                                 |   |      |             |                        |     |          |                             |                           |    |          |                                  |                      |    |          |                       |                             |    |    |          |  |   |    |          |                              |   |    |          |                               |   |    |          |                    |   |    |          |   |    |    |          |              |   |    |          |                         |   |    |          |              |   |    |          |   |   |   |          |   |   |    |          |              |       |   |          |                                      |   |    |          |  |   |    |          |                                |   |    |



| COMPONENT |  |   | SPARE PART |                                       |  |             |             |                             |     |          |  |                              |    |          |             |   |    |          |                 |   |       |          |   |                                      |    |          |   |  |    |          |   |                                |    |          |                             |  |    |          |                                  |             |    |          |                       |                 |    |    |          |   |   |    |
|-----------|--|---|------------|---------------------------------------|--|-------------|-------------|-----------------------------|-----|----------|--|------------------------------|----|----------|-------------|---|----|----------|-----------------|---|-------|----------|---|--------------------------------------|----|----------|---|--|----|----------|---|--------------------------------|----|----------|-----------------------------|--|----|----------|----------------------------------|-------------|----|----------|-----------------------|-----------------|----|----|----------|---|---|----|
| Code      | Description  | Image   | Code       | Description                           | Components list  |             |             |                             |     |          |  |                              |    |          |             |   |    |          |                 |   |       |          |   |                                      |    |          |   |  |    |          |   |                                |    |          |                             |  |    |          |                                  |             |    |          |                       |                 |    |    |          |   |   |    |
| VL1005A   | U-TRAP TANK  |    | XC755      | E SERIES BT-CT GN<br>2/1 STACKING KIT | <table border="1"> <thead> <tr> <th>Code</th> <th>Description</th> <th>Qty</th> <th>UOM</th> </tr> </thead> <tbody> <tr> <td>VL1950A0</td> <td>ST. STEEL<br/>4,2X13 TCB<br/>SELF-DRILLIN<br/>G SCREW</td> <td>26</td> <td>PZ</td> </tr> <tr> <td>VL1005A1</td> <td>U-TRAP TANK</td> <td>2</td> <td>PZ</td> </tr> <tr> <td>VL1006A0</td> <td>SYPHON<br/>COVER</td> <td>2</td> <td>PZ</td> </tr> <tr> <td>VL1043A0</td> <td>D4 PIPE<br/>HOLDER - D6<br/>J.G. TERMINAL</td> <td>3</td> <td>PZ</td> </tr> <tr> <td>VL1046A1</td> <td>D6 PIPE<br/>HOLDER - D6<br/>J.G. TERMINAL</td> <td>3</td> <td>PZ</td> </tr> <tr> <td>VM1015A1</td> <td>STAINLESS<br/>STEEL<br/>Ø30X1.5 90°<br/>BEND</td> <td>1</td> <td>PZ</td> </tr> <tr> <td>VM1794A0</td> <td>250X4.8 PA66<br/>BLACK CLAMP</td> <td>3</td> <td>PZ</td> </tr> <tr> <td>VM1987A0</td> <td>BRACKET FOR<br/>OVENS<br/>STACKING</td> <td>1</td> <td>PZ</td> </tr> <tr> <td>VM2035A0</td> <td>DRAIN PIPE<br/>SUPPORT</td> <td>2</td> <td>PZ</td> </tr> </tbody> </table> | Code        | Description | Qty                         | UOM | VL1950A0 | ST. STEEL<br>4,2X13 TCB<br>SELF-DRILLIN<br>G SCREW | 26                           | PZ | VL1005A1 | U-TRAP TANK | 2   | PZ | VL1006A0 | SYPHON<br>COVER | 2   | PZ    | VL1043A0 | D4 PIPE<br>HOLDER - D6<br>J.G. TERMINAL | 3                                    | PZ | VL1046A1 | D6 PIPE<br>HOLDER - D6<br>J.G. TERMINAL | 3  | PZ | VM1015A1 | STAINLESS<br>STEEL<br>Ø30X1.5 90°<br>BEND | 1                              | PZ | VM1794A0 | 250X4.8 PA66<br>BLACK CLAMP | 3  | PZ | VM1987A0 | BRACKET FOR<br>OVENS<br>STACKING | 1           | PZ | VM2035A0 | DRAIN PIPE<br>SUPPORT | 2               | PZ |    |          |   |   |    |
|           |  |   |            |                                       | Code   | Description | Qty         | UOM                         |     |          |  |                              |    |          |             |   |    |          |                 |   |       |          |   |                                      |    |          |   |  |    |          |   |                                |    |          |                             |  |    |          |                                  |             |    |          |                       |                 |    |    |          |   |   |    |
| VL1950A0  | ST. STEEL<br>4,2X13 TCB<br>SELF-DRILLIN<br>G SCREW | 26  | PZ         |                                       |  |             |             |                             |     |          |  |                              |    |          |             |   |    |          |                 |   |       |          |   |                                      |    |          |   |  |    |          |   |                                |    |          |                             |  |    |          |                                  |             |    |          |                       |                 |    |    |          |   |   |    |
| VL1005A1  | U-TRAP TANK  | 2   | PZ         |                                       |  |             |             |                             |     |          |  |                              |    |          |             |   |    |          |                 |   |       |          |   |                                      |    |          |   |  |    |          |   |                                |    |          |                             |  |    |          |                                  |             |    |          |                       |                 |    |    |          |   |   |    |
| VL1006A0  | SYPHON<br>COVER                                    | 2   | PZ         |                                       |  |             |             |                             |     |          |  |                              |    |          |             |   |    |          |                 |   |       |          |   |                                      |    |          |   |  |    |          |   |                                |    |          |                             |  |    |          |                                  |             |    |          |                       |                 |    |    |          |   |   |    |
| VL1043A0  | D4 PIPE<br>HOLDER - D6<br>J.G. TERMINAL            | 3   | PZ         |                                       |  |             |             |                             |     |          |  |                              |    |          |             |   |    |          |                 |   |       |          |   |                                      |    |          |   |  |    |          |   |                                |    |          |                             |  |    |          |                                  |             |    |          |                       |                 |    |    |          |   |   |    |
| VL1046A1  | D6 PIPE<br>HOLDER - D6<br>J.G. TERMINAL            | 3   | PZ         |                                       |  |             |             |                             |     |          |  |                              |    |          |             |   |    |          |                 |   |       |          |   |                                      |    |          |   |  |    |          |   |                                |    |          |                             |  |    |          |                                  |             |    |          |                       |                 |    |    |          |   |   |    |
| VM1015A1  | STAINLESS<br>STEEL<br>Ø30X1.5 90°<br>BEND          | 1   | PZ         |                                       |  |             |             |                             |     |          |  |                              |    |          |             |   |    |          |                 |   |       |          |   |                                      |    |          |   |  |    |          |   |                                |    |          |                             |  |    |          |                                  |             |    |          |                       |                 |    |    |          |   |   |    |
| VM1794A0  | 250X4.8 PA66<br>BLACK CLAMP                        | 3   | PZ         |                                       |  |             |             |                             |     |          |  |                              |    |          |             |   |    |          |                 |   |       |          |   |                                      |    |          |   |  |    |          |   |                                |    |          |                             |  |    |          |                                  |             |    |          |                       |                 |    |    |          |   |   |    |
| VM1987A0  | BRACKET FOR<br>OVENS<br>STACKING                   | 1   | PZ         |                                       |  |             |             |                             |     |          |  |                              |    |          |             |   |    |          |                 |   |       |          |   |                                      |    |          |   |  |    |          |   |                                |    |          |                             |  |    |          |                                  |             |    |          |                       |                 |    |    |          |   |   |    |
| VM2035A0  | DRAIN PIPE<br>SUPPORT                              | 2   | PZ         |                                       |  |             |             |                             |     |          |  |                              |    |          |             |   |    |          |                 |   |       |          |   |                                      |    |          |   |  |    |          |   |                                |    |          |                             |  |    |          |                                  |             |    |          |                       |                 |    |    |          |   |   |    |
| XC699     | LINEMISS TOP<br>FIRST<br>INSTALLATION KIT          | <table border="1"> <thead> <tr> <th>Code</th> <th>Description</th> <th>Qty</th> <th>UOM</th> </tr> </thead> <tbody> <tr> <td>0H1237A0</td> <td>LM TOP<br/>SIPHON<br/>SUPPORT</td> <td>1</td> <td>PZ</td> </tr> <tr> <td>GN1508A0</td> <td>O-RING<br/>GASKET COD<br/>2400</td> <td>1</td> <td>PZ</td> </tr> <tr> <td>RC1055A0</td> <td>Ø25-40 H12<br/>STAINLESS<br/>STEEL PIPE<br/>CLIP</td> <td>4</td> <td>PZ</td> </tr> <tr> <td>TB1520A0</td> <td>INT. Ø=38<br/>TH=4 DRAIN<br/>BLACK<br/>RUBBER PIPE</td> <td>2.500</td> <td>M</td> </tr> <tr> <td>VI1220A1</td> <td>4,2X12 TCB<br/>SELF-TAPPIN<br/>G SCREW</td> <td>2</td> <td>PZ</td> </tr> <tr> <td>VI1895A0</td> <td>BLIND NUT M4<br/>STAINLESS<br/>STEEL DIN 917</td> <td>4</td> <td>PZ</td> </tr> <tr> <td>VI1945A0</td> <td>ENG-VITE<br/>M4X20 TCB+<br/>INOX</td> <td>4</td> <td>PZ</td> </tr> <tr> <td>VI1950A0</td> <td>ST. STEEL<br/>4,2X13 TCB<br/>SELF-DRILLIN<br/>G SCREW</td> <td>2</td> <td>PZ</td> </tr> <tr> <td>VL1005A1</td> <td>U-TRAP TANK</td> <td>1</td> <td>PZ</td> </tr> <tr> <td>VL1006A0</td> <td>SYPHON<br/>COVER</td> <td>1</td> <td>PZ</td> </tr> <tr> <td>VM1015A1</td> <td>STAINLESS<br/>STEEL<br/>Ø30X1.5 90°<br/>BEND</td> <td>1</td> <td>PZ</td> </tr> </tbody> </table> | Code       | Description                           | Qty  | UOM         | 0H1237A0    | LM TOP<br>SIPHON<br>SUPPORT | 1   | PZ       | GN1508A0   | O-RING<br>GASKET COD<br>2400 | 1  | PZ       | RC1055A0    | Ø25-40 H12<br>STAINLESS<br>STEEL PIPE<br>CLIP | 4  | PZ       | TB1520A0        | INT. Ø=38<br>TH=4 DRAIN<br>BLACK<br>RUBBER PIPE | 2.500 | M        | VI1220A1                                | 4,2X12 TCB<br>SELF-TAPPIN<br>G SCREW | 2  | PZ       | VI1895A0                                | BLIND NUT M4<br>STAINLESS<br>STEEL DIN 917 | 4  | PZ       | VI1945A0                                  | ENG-VITE<br>M4X20 TCB+<br>INOX | 4  | PZ       | VI1950A0                    | ST. STEEL<br>4,2X13 TCB<br>SELF-DRILLIN<br>G SCREW | 2  | PZ       | VL1005A1                         | U-TRAP TANK | 1  | PZ       | VL1006A0              | SYPHON<br>COVER | 1  | PZ | VM1015A1 | STAINLESS<br>STEEL<br>Ø30X1.5 90°<br>BEND | 1 | PZ |
| Code      | Description  | Qty   | UOM        |                                       |  |             |             |                             |     |          |  |                              |    |          |             |   |    |          |                 |   |       |          |   |                                      |    |          |   |  |    |          |   |                                |    |          |                             |  |    |          |                                  |             |    |          |                       |                 |    |    |          |   |   |    |
| 0H1237A0  | LM TOP<br>SIPHON<br>SUPPORT                        | 1   | PZ         |                                       |  |             |             |                             |     |          |  |                              |    |          |             |   |    |          |                 |   |       |          |   |                                      |    |          |   |  |    |          |   |                                |    |          |                             |  |    |          |                                  |             |    |          |                       |                 |    |    |          |   |   |    |
| GN1508A0  | O-RING<br>GASKET COD<br>2400                       | 1   | PZ         |                                       |  |             |             |                             |     |          |  |                              |    |          |             |   |    |          |                 |   |       |          |   |                                      |    |          |   |  |    |          |   |                                |    |          |                             |  |    |          |                                  |             |    |          |                       |                 |    |    |          |   |   |    |
| RC1055A0  | Ø25-40 H12<br>STAINLESS<br>STEEL PIPE<br>CLIP      | 4   | PZ         |                                       |  |             |             |                             |     |          |  |                              |    |          |             |   |    |          |                 |   |       |          |   |                                      |    |          |   |  |    |          |   |                                |    |          |                             |  |    |          |                                  |             |    |          |                       |                 |    |    |          |   |   |    |
| TB1520A0  | INT. Ø=38<br>TH=4 DRAIN<br>BLACK<br>RUBBER PIPE    | 2.500   | M          |                                       |  |             |             |                             |     |          |  |                              |    |          |             |   |    |          |                 |   |       |          |   |                                      |    |          |   |  |    |          |   |                                |    |          |                             |  |    |          |                                  |             |    |          |                       |                 |    |    |          |   |   |    |
| VI1220A1  | 4,2X12 TCB<br>SELF-TAPPIN<br>G SCREW               | 2   | PZ         |                                       |  |             |             |                             |     |          |  |                              |    |          |             |   |    |          |                 |   |       |          |   |                                      |    |          |   |  |    |          |   |                                |    |          |                             |  |    |          |                                  |             |    |          |                       |                 |    |    |          |   |   |    |
| VI1895A0  | BLIND NUT M4<br>STAINLESS<br>STEEL DIN 917         | 4   | PZ         |                                       |  |             |             |                             |     |          |  |                              |    |          |             |   |    |          |                 |   |       |          |   |                                      |    |          |   |  |    |          |   |                                |    |          |                             |  |    |          |                                  |             |    |          |                       |                 |    |    |          |   |   |    |
| VI1945A0  | ENG-VITE<br>M4X20 TCB+<br>INOX                     | 4   | PZ         |                                       |  |             |             |                             |     |          |  |                              |    |          |             |   |    |          |                 |   |       |          |   |                                      |    |          |   |  |    |          |   |                                |    |          |                             |  |    |          |                                  |             |    |          |                       |                 |    |    |          |   |   |    |
| VI1950A0  | ST. STEEL<br>4,2X13 TCB<br>SELF-DRILLIN<br>G SCREW | 2   | PZ         |                                       |  |             |             |                             |     |          |  |                              |    |          |             |   |    |          |                 |   |       |          |   |                                      |    |          |   |  |    |          |   |                                |    |          |                             |  |    |          |                                  |             |    |          |                       |                 |    |    |          |   |   |    |
| VL1005A1  | U-TRAP TANK  | 1   | PZ         |                                       |  |             |             |                             |     |          |  |                              |    |          |             |   |    |          |                 |   |       |          |   |                                      |    |          |   |  |    |          |   |                                |    |          |                             |  |    |          |                                  |             |    |          |                       |                 |    |    |          |   |   |    |
| VL1006A0  | SYPHON<br>COVER                                    | 1   | PZ         |                                       |  |             |             |                             |     |          |  |                              |    |          |             |   |    |          |                 |   |       |          |   |                                      |    |          |   |  |    |          |   |                                |    |          |                             |  |    |          |                                  |             |    |          |                       |                 |    |    |          |   |   |    |
| VM1015A1  | STAINLESS<br>STEEL<br>Ø30X1.5 90°<br>BEND          | 1   | PZ         |                                       |  |             |             |                             |     |          |  |                              |    |          |             |   |    |          |                 |   |       |          |   |                                      |    |          |   |  |    |          |   |                                |    |          |                             |  |    |          |                                  |             |    |          |                       |                 |    |    |          |   |   |    |

| COMPONENT |  |   | SPARE PART |                     |  |      |             |                             |     |          |                              |                                    |    |          |   |  |    |          |   |                      |   |          |                                      |                             |    |          |  |  |    |          |                                |   |    |          |  |                              |    |          |             |                    |    |          |                 |   |    |
|-----------|--|---|------------|---------------------|--|------|-------------|-----------------------------|-----|----------|------------------------------|------------------------------------|----|----------|---|--|----|----------|---|----------------------|---|----------|--------------------------------------|-----------------------------|----|----------|--|--|----|----------|--------------------------------|---|----|----------|--|------------------------------|----|----------|-------------|--------------------|----|----------|-----------------|---|----|
| Code      | Description  | Image   | Code       | Description         | Components list  |      |             |                             |     |          |                              |                                    |    |          |   |  |    |          |   |                      |   |          |                                      |                             |    |          |  |  |    |          |                                |   |    |          |  |                              |    |          |             |                    |    |          |                 |   |    |
| VL1005A   | U-TRAP TANK  |    | XC673      | COMPLETE P-TRAP KIT | <table border="1"> <thead> <tr> <th>Code</th> <th>Description</th> <th>Qty</th> <th>UOM</th> </tr> </thead> <tbody> <tr> <td>GN1508A0</td> <td>O-RING<br/>GASKET COD<br/>2400</td> <td>1</td> <td>PZ</td> </tr> <tr> <td>RC1055A0</td> <td>Ø25-40 H12<br/>STAINLESS<br/>STEEL PIPE<br/>CLIP</td> <td>2</td> <td>PZ</td> </tr> <tr> <td>TB1520A0</td> <td>INT. Ø=38<br/>TH=4 DRAIN<br/>BLACK<br/>RUBBER PIPE</td> <td>0.050</td> <td>M</td> </tr> <tr> <td>VI1220A1</td> <td>4,2X12 TCB<br/>SELF-TAPPIN<br/>G SCREW</td> <td>2</td> <td>PZ</td> </tr> <tr> <td>VI1895A0</td> <td>BLIND NUT M4<br/>STAINLESS<br/>STEEL DIN 917</td> <td>4</td> <td>PZ</td> </tr> <tr> <td>VI1945A0</td> <td>ENG-VITE<br/>M4X20 TCB+<br/>INOX</td> <td>4</td> <td>PZ</td> </tr> <tr> <td>VI1950A0</td> <td>ST. STEEL<br/>4,2X13 TCB<br/>SELF-DRILLIN<br/>G SCREW</td> <td>2</td> <td>PZ</td> </tr> <tr> <td>VL1005A1</td> <td>U-TRAP TANK</td> <td>1</td> <td>PZ</td> </tr> <tr> <td>VL1006A0</td> <td>SYPHON<br/>COVER</td> <td>1</td> <td>PZ</td> </tr> </tbody> </table> | Code | Description | Qty                         | UOM | GN1508A0 | O-RING<br>GASKET COD<br>2400 | 1                                  | PZ | RC1055A0 | Ø25-40 H12<br>STAINLESS<br>STEEL PIPE<br>CLIP | 2  | PZ | TB1520A0 | INT. Ø=38<br>TH=4 DRAIN<br>BLACK<br>RUBBER PIPE | 0.050                | M | VI1220A1 | 4,2X12 TCB<br>SELF-TAPPIN<br>G SCREW | 2                           | PZ | VI1895A0 | BLIND NUT M4<br>STAINLESS<br>STEEL DIN 917 | 4  | PZ | VI1945A0 | ENG-VITE<br>M4X20 TCB+<br>INOX | 4   | PZ | VI1950A0 | ST. STEEL<br>4,2X13 TCB<br>SELF-DRILLIN<br>G SCREW | 2                            | PZ | VL1005A1 | U-TRAP TANK | 1                  | PZ | VL1006A0 | SYPHON<br>COVER | 1 | PZ |
|           |  |   | Code       | Description         | Qty  | UOM  |             |                             |     |          |                              |                                    |    |          |   |  |    |          |   |                      |   |          |                                      |                             |    |          |  |  |    |          |                                |   |    |          |  |                              |    |          |             |                    |    |          |                 |   |    |
| GN1508A0  | O-RING<br>GASKET COD<br>2400                       | 1   | PZ         |                     |  |      |             |                             |     |          |                              |                                    |    |          |   |  |    |          |   |                      |   |          |                                      |                             |    |          |  |  |    |          |                                |   |    |          |  |                              |    |          |             |                    |    |          |                 |   |    |
| RC1055A0  | Ø25-40 H12<br>STAINLESS<br>STEEL PIPE<br>CLIP      | 2   | PZ         |                     |  |      |             |                             |     |          |                              |                                    |    |          |   |  |    |          |   |                      |   |          |                                      |                             |    |          |  |  |    |          |                                |   |    |          |  |                              |    |          |             |                    |    |          |                 |   |    |
| TB1520A0  | INT. Ø=38<br>TH=4 DRAIN<br>BLACK<br>RUBBER PIPE    | 0.050   | M          |                     |  |      |             |                             |     |          |                              |                                    |    |          |   |  |    |          |   |                      |   |          |                                      |                             |    |          |  |  |    |          |                                |   |    |          |  |                              |    |          |             |                    |    |          |                 |   |    |
| VI1220A1  | 4,2X12 TCB<br>SELF-TAPPIN<br>G SCREW               | 2   | PZ         |                     |  |      |             |                             |     |          |                              |                                    |    |          |   |  |    |          |   |                      |   |          |                                      |                             |    |          |  |  |    |          |                                |   |    |          |  |                              |    |          |             |                    |    |          |                 |   |    |
| VI1895A0  | BLIND NUT M4<br>STAINLESS<br>STEEL DIN 917         | 4   | PZ         |                     |  |      |             |                             |     |          |                              |                                    |    |          |   |  |    |          |   |                      |   |          |                                      |                             |    |          |  |  |    |          |                                |   |    |          |  |                              |    |          |             |                    |    |          |                 |   |    |
| VI1945A0  | ENG-VITE<br>M4X20 TCB+<br>INOX                     | 4   | PZ         |                     |  |      |             |                             |     |          |                              |                                    |    |          |   |  |    |          |   |                      |   |          |                                      |                             |    |          |  |  |    |          |                                |   |    |          |  |                              |    |          |             |                    |    |          |                 |   |    |
| VI1950A0  | ST. STEEL<br>4,2X13 TCB<br>SELF-DRILLIN<br>G SCREW | 2   | PZ         |                     |  |      |             |                             |     |          |                              |                                    |    |          |   |  |    |          |   |                      |   |          |                                      |                             |    |          |  |  |    |          |                                |   |    |          |  |                              |    |          |             |                    |    |          |                 |   |    |
| VL1005A1  | U-TRAP TANK  | 1   | PZ         |                     |  |      |             |                             |     |          |                              |                                    |    |          |   |  |    |          |   |                      |   |          |                                      |                             |    |          |  |  |    |          |                                |   |    |          |  |                              |    |          |             |                    |    |          |                 |   |    |
| VL1006A0  | SYPHON<br>COVER                                    | 1   | PZ         |                     |  |      |             |                             |     |          |                              |                                    |    |          |   |  |    |          |   |                      |   |          |                                      |                             |    |          |  |  |    |          |                                |   |    |          |  |                              |    |          |             |                    |    |          |                 |   |    |
| XC653     | LINEMISSTOP XFT140 STACKING KIT                    | <table border="1"> <thead> <tr> <th>Code</th> <th>Description</th> <th>Qty</th> <th>UOM</th> </tr> </thead> <tbody> <tr> <td>0H1237A0</td> <td>LM TOP<br/>SIPHON<br/>SUPPORT</td> <td>2</td> <td>PZ</td> </tr> <tr> <td>0H7084A0</td> <td>XC651 FRONT<br/>STACKING<br/>PROFILE</td> <td>1</td> <td>PZ</td> </tr> <tr> <td>0H7085A0</td> <td>LM 600 XC<br/>STACKING KIT<br/>BACK PROFIL</td> <td>2</td> <td>PZ</td> </tr> <tr> <td>ED1246A0</td> <td>HOT SURFACE<br/>LABEL</td> <td>1</td> <td>PZ</td> </tr> <tr> <td>ED1271A0</td> <td>LIQUID FALLS<br/>DANGER LABE</td> <td>1</td> <td>PZ</td> </tr> <tr> <td>EL1020A1</td> <td>D8<br/>INTERMEDIAT<br/>E T-SHAPED<br/>FITTING</td> <td>2</td> <td>PZ</td> </tr> <tr> <td>EL1180A0</td> <td>Ø8-Ø8<br/>FEMALE<br/>NON-RETURN<br/>CONNECTION</td> <td>2</td> <td>PZ</td> </tr> <tr> <td>GN1508A0</td> <td>O-RING<br/>GASKET COD<br/>2400</td> <td>2</td> <td>PZ</td> </tr> <tr> <td>RC1008A0</td> <td>D9 ELASTIC<br/>CLIP</td> <td>7</td> <td>PZ</td> </tr> </tbody> </table> | Code       | Description         | Qty  | UOM  | 0H1237A0    | LM TOP<br>SIPHON<br>SUPPORT | 2   | PZ       | 0H7084A0                     | XC651 FRONT<br>STACKING<br>PROFILE | 1  | PZ       | 0H7085A0                                      | LM 600 XC<br>STACKING KIT<br>BACK PROFIL | 2  | PZ       | ED1246A0  | HOT SURFACE<br>LABEL | 1 | PZ       | ED1271A0                             | LIQUID FALLS<br>DANGER LABE | 1  | PZ       | EL1020A1                                   | D8<br>INTERMEDIAT<br>E T-SHAPED<br>FITTING | 2  | PZ       | EL1180A0                       | Ø8-Ø8<br>FEMALE<br>NON-RETURN<br>CONNECTION | 2  | PZ       | GN1508A0   | O-RING<br>GASKET COD<br>2400 | 2  | PZ       | RC1008A0    | D9 ELASTIC<br>CLIP | 7  | PZ       |                 |   |    |
| Code      | Description  | Qty   | UOM        |                     |  |      |             |                             |     |          |                              |                                    |    |          |   |  |    |          |   |                      |   |          |                                      |                             |    |          |  |  |    |          |                                |   |    |          |  |                              |    |          |             |                    |    |          |                 |   |    |
| 0H1237A0  | LM TOP<br>SIPHON<br>SUPPORT                        | 2   | PZ         |                     |  |      |             |                             |     |          |                              |                                    |    |          |   |  |    |          |   |                      |   |          |                                      |                             |    |          |  |  |    |          |                                |   |    |          |  |                              |    |          |             |                    |    |          |                 |   |    |
| 0H7084A0  | XC651 FRONT<br>STACKING<br>PROFILE                 | 1   | PZ         |                     |  |      |             |                             |     |          |                              |                                    |    |          |   |  |    |          |   |                      |   |          |                                      |                             |    |          |  |  |    |          |                                |   |    |          |  |                              |    |          |             |                    |    |          |                 |   |    |
| 0H7085A0  | LM 600 XC<br>STACKING KIT<br>BACK PROFIL           | 2   | PZ         |                     |  |      |             |                             |     |          |                              |                                    |    |          |   |  |    |          |   |                      |   |          |                                      |                             |    |          |  |  |    |          |                                |   |    |          |  |                              |    |          |             |                    |    |          |                 |   |    |
| ED1246A0  | HOT SURFACE<br>LABEL                               | 1   | PZ         |                     |  |      |             |                             |     |          |                              |                                    |    |          |   |  |    |          |   |                      |   |          |                                      |                             |    |          |  |  |    |          |                                |   |    |          |  |                              |    |          |             |                    |    |          |                 |   |    |
| ED1271A0  | LIQUID FALLS<br>DANGER LABE                        | 1   | PZ         |                     |  |      |             |                             |     |          |                              |                                    |    |          |   |  |    |          |   |                      |   |          |                                      |                             |    |          |  |  |    |          |                                |   |    |          |  |                              |    |          |             |                    |    |          |                 |   |    |
| EL1020A1  | D8<br>INTERMEDIAT<br>E T-SHAPED<br>FITTING         | 2   | PZ         |                     |  |      |             |                             |     |          |                              |                                    |    |          |   |  |    |          |   |                      |   |          |                                      |                             |    |          |  |  |    |          |                                |   |    |          |  |                              |    |          |             |                    |    |          |                 |   |    |
| EL1180A0  | Ø8-Ø8<br>FEMALE<br>NON-RETURN<br>CONNECTION        | 2   | PZ         |                     |  |      |             |                             |     |          |                              |                                    |    |          |   |  |    |          |   |                      |   |          |                                      |                             |    |          |  |  |    |          |                                |   |    |          |  |                              |    |          |             |                    |    |          |                 |   |    |
| GN1508A0  | O-RING<br>GASKET COD<br>2400                       | 2   | PZ         |                     |  |      |             |                             |     |          |                              |                                    |    |          |   |  |    |          |   |                      |   |          |                                      |                             |    |          |  |  |    |          |                                |   |    |          |  |                              |    |          |             |                    |    |          |                 |   |    |
| RC1008A0  | D9 ELASTIC<br>CLIP                                 | 7   | PZ         |                     |  |      |             |                             |     |          |                              |                                    |    |          |   |  |    |          |   |                      |   |          |                                      |                             |    |          |  |  |    |          |                                |   |    |          |  |                              |    |          |             |                    |    |          |                 |   |    |



| COMPONENT |  |   | SPARE PART |                                       |  |      |             |     |     |          |   |    |    |          |                         |   |    |          |                             |   |    |          |              |   |    |          |                                       |   |    |          |   |       |   |          |   |   |   |          |              |       |   |          |                                      |    |    |          |  |   |    |          |                                |   |    |          |  |    |    |          |             |   |    |          |                 |   |    |          |   |   |    |          |   |   |    |          |   |   |    |          |                             |   |    |          |                       |   |    |
|-----------|--|---|------------|---------------------------------------|--|------|-------------|-----|-----|----------|---|----|----|----------|-------------------------|---|----|----------|-----------------------------|---|----|----------|--------------|---|----|----------|---------------------------------------|---|----|----------|---|-------|---|----------|---|---|---|----------|--------------|-------|---|----------|--------------------------------------|----|----|----------|--|---|----|----------|--------------------------------|---|----|----------|--|----|----|----------|-------------|---|----|----------|-----------------|---|----|----------|---|---|----|----------|---|---|----|----------|---|---|----|----------|-----------------------------|---|----|----------|-----------------------|---|----|
| Code      | Description  | Image   | Code       | Description                           | Components list  |      |             |     |     |          |   |    |    |          |                         |   |    |          |                             |   |    |          |              |   |    |          |                                       |   |    |          |   |       |   |          |   |   |   |          |              |       |   |          |                                      |    |    |          |  |   |    |          |                                |   |    |          |  |    |    |          |             |   |    |          |                 |   |    |          |   |   |    |          |   |   |    |          |   |   |    |          |                             |   |    |          |                       |   |    |
| VL1005A   | U-TRAP TANK  |  | XC653      | LINEMISSTOP<br>XFT140 STACKING<br>KIT | <table border="1"> <thead> <tr> <th>Code</th> <th>Description</th> <th>Qty</th> <th>UOM</th> </tr> </thead> <tbody> <tr> <td>RC1055A0</td> <td>Ø25-40 H12<br/>STAINLESS<br/>STEEL PIPE<br/>CLIP</td> <td>10</td> <td>PZ</td> </tr> <tr> <td>RC1297A1</td> <td>D10 T-SHAPED<br/>FITTING</td> <td>1</td> <td>PZ</td> </tr> <tr> <td>RC1360A0</td> <td>10 - 10 JG<br/>ELBOW FITTING</td> <td>1</td> <td>PZ</td> </tr> <tr> <td>RC1376A0</td> <td>Ø6 Y-FITTING</td> <td>1</td> <td>PZ</td> </tr> <tr> <td>TB1177A0</td> <td>FOOT PANEL<br/>40X40 H58<br/>OVERLAP LM</td> <td>4</td> <td>PZ</td> </tr> <tr> <td>TB1520A0</td> <td>INT. Ø=38<br/>TH=4 DRAIN<br/>BLACK<br/>RUBBER PIPE</td> <td>2.700</td> <td>M</td> </tr> <tr> <td>TB1815A0</td> <td>7,93X4,75 PE<br/>TRANSP. PIPE<br/>(JG<br/>#PE08100N)</td> <td>2</td> <td>M</td> </tr> <tr> <td>TB2243A0</td> <td>Ø10 PET PIPE</td> <td>1.500</td> <td>M</td> </tr> <tr> <td>VI1220A1</td> <td>4,2X12 TCB<br/>SELF-TAPPIN<br/>G SCREW</td> <td>16</td> <td>PZ</td> </tr> <tr> <td>VI1895A0</td> <td>BLIND NUT M4<br/>STAINLESS<br/>STEEL DIN 917</td> <td>8</td> <td>PZ</td> </tr> <tr> <td>VI1945A0</td> <td>ENG-VITE<br/>M4X20 TCB+<br/>INOX</td> <td>8</td> <td>PZ</td> </tr> <tr> <td>VI1950A0</td> <td>ST. STEEL<br/>4,2X13 TCB<br/>SELF-DRILLIN<br/>G SCREW</td> <td>10</td> <td>PZ</td> </tr> <tr> <td>VL1005A1</td> <td>U-TRAP TANK</td> <td>2</td> <td>PZ</td> </tr> <tr> <td>VL1006A0</td> <td>SYPHON<br/>COVER</td> <td>2</td> <td>PZ</td> </tr> <tr> <td>VL1046A1</td> <td>D6 PIPE<br/>HOLDER - D6<br/>J.G. TERMINAL</td> <td>6</td> <td>PZ</td> </tr> <tr> <td>VL1047A1</td> <td>D6 PIPE<br/>HOLDER - D8<br/>J.G. TERMINAL</td> <td>2</td> <td>PZ</td> </tr> <tr> <td>VM1015A1</td> <td>STAINLESS<br/>STEEL<br/>Ø30X1.5 90°<br/>BEND</td> <td>1</td> <td>PZ</td> </tr> <tr> <td>VM1794A0</td> <td>250X4.8 PA66<br/>BLACK CLAMP</td> <td>2</td> <td>PZ</td> </tr> <tr> <td>VM2035A0</td> <td>DRAIN PIPE<br/>SUPPORT</td> <td>1</td> <td>PZ</td> </tr> </tbody> </table> | Code | Description | Qty | UOM | RC1055A0 | Ø25-40 H12<br>STAINLESS<br>STEEL PIPE<br>CLIP | 10 | PZ | RC1297A1 | D10 T-SHAPED<br>FITTING | 1 | PZ | RC1360A0 | 10 - 10 JG<br>ELBOW FITTING | 1 | PZ | RC1376A0 | Ø6 Y-FITTING | 1 | PZ | TB1177A0 | FOOT PANEL<br>40X40 H58<br>OVERLAP LM | 4 | PZ | TB1520A0 | INT. Ø=38<br>TH=4 DRAIN<br>BLACK<br>RUBBER PIPE | 2.700 | M | TB1815A0 | 7,93X4,75 PE<br>TRANSP. PIPE<br>(JG<br>#PE08100N) | 2 | M | TB2243A0 | Ø10 PET PIPE | 1.500 | M | VI1220A1 | 4,2X12 TCB<br>SELF-TAPPIN<br>G SCREW | 16 | PZ | VI1895A0 | BLIND NUT M4<br>STAINLESS<br>STEEL DIN 917 | 8 | PZ | VI1945A0 | ENG-VITE<br>M4X20 TCB+<br>INOX | 8 | PZ | VI1950A0 | ST. STEEL<br>4,2X13 TCB<br>SELF-DRILLIN<br>G SCREW | 10 | PZ | VL1005A1 | U-TRAP TANK | 2 | PZ | VL1006A0 | SYPHON<br>COVER | 2 | PZ | VL1046A1 | D6 PIPE<br>HOLDER - D6<br>J.G. TERMINAL | 6 | PZ | VL1047A1 | D6 PIPE<br>HOLDER - D8<br>J.G. TERMINAL | 2 | PZ | VM1015A1 | STAINLESS<br>STEEL<br>Ø30X1.5 90°<br>BEND | 1 | PZ | VM1794A0 | 250X4.8 PA66<br>BLACK CLAMP | 2 | PZ | VM2035A0 | DRAIN PIPE<br>SUPPORT | 1 | PZ |
| Code      | Description  | Qty   | UOM        |                                       |  |      |             |     |     |          |   |    |    |          |                         |   |    |          |                             |   |    |          |              |   |    |          |                                       |   |    |          |   |       |   |          |   |   |   |          |              |       |   |          |                                      |    |    |          |  |   |    |          |                                |   |    |          |  |    |    |          |             |   |    |          |                 |   |    |          |   |   |    |          |   |   |    |          |   |   |    |          |                             |   |    |          |                       |   |    |
| RC1055A0  | Ø25-40 H12<br>STAINLESS<br>STEEL PIPE<br>CLIP      | 10  | PZ         |                                       |  |      |             |     |     |          |   |    |    |          |                         |   |    |          |                             |   |    |          |              |   |    |          |                                       |   |    |          |   |       |   |          |   |   |   |          |              |       |   |          |                                      |    |    |          |  |   |    |          |                                |   |    |          |  |    |    |          |             |   |    |          |                 |   |    |          |   |   |    |          |   |   |    |          |   |   |    |          |                             |   |    |          |                       |   |    |
| RC1297A1  | D10 T-SHAPED<br>FITTING                            | 1   | PZ         |                                       |  |      |             |     |     |          |   |    |    |          |                         |   |    |          |                             |   |    |          |              |   |    |          |                                       |   |    |          |   |       |   |          |   |   |   |          |              |       |   |          |                                      |    |    |          |  |   |    |          |                                |   |    |          |  |    |    |          |             |   |    |          |                 |   |    |          |   |   |    |          |   |   |    |          |   |   |    |          |                             |   |    |          |                       |   |    |
| RC1360A0  | 10 - 10 JG<br>ELBOW FITTING                        | 1   | PZ         |                                       |  |      |             |     |     |          |   |    |    |          |                         |   |    |          |                             |   |    |          |              |   |    |          |                                       |   |    |          |   |       |   |          |   |   |   |          |              |       |   |          |                                      |    |    |          |  |   |    |          |                                |   |    |          |  |    |    |          |             |   |    |          |                 |   |    |          |   |   |    |          |   |   |    |          |   |   |    |          |                             |   |    |          |                       |   |    |
| RC1376A0  | Ø6 Y-FITTING                                       | 1   | PZ         |                                       |  |      |             |     |     |          |   |    |    |          |                         |   |    |          |                             |   |    |          |              |   |    |          |                                       |   |    |          |   |       |   |          |   |   |   |          |              |       |   |          |                                      |    |    |          |  |   |    |          |                                |   |    |          |  |    |    |          |             |   |    |          |                 |   |    |          |   |   |    |          |   |   |    |          |   |   |    |          |                             |   |    |          |                       |   |    |
| TB1177A0  | FOOT PANEL<br>40X40 H58<br>OVERLAP LM              | 4   | PZ         |                                       |  |      |             |     |     |          |   |    |    |          |                         |   |    |          |                             |   |    |          |              |   |    |          |                                       |   |    |          |   |       |   |          |   |   |   |          |              |       |   |          |                                      |    |    |          |  |   |    |          |                                |   |    |          |  |    |    |          |             |   |    |          |                 |   |    |          |   |   |    |          |   |   |    |          |   |   |    |          |                             |   |    |          |                       |   |    |
| TB1520A0  | INT. Ø=38<br>TH=4 DRAIN<br>BLACK<br>RUBBER PIPE    | 2.700   | M          |                                       |  |      |             |     |     |          |   |    |    |          |                         |   |    |          |                             |   |    |          |              |   |    |          |                                       |   |    |          |   |       |   |          |   |   |   |          |              |       |   |          |                                      |    |    |          |  |   |    |          |                                |   |    |          |  |    |    |          |             |   |    |          |                 |   |    |          |   |   |    |          |   |   |    |          |   |   |    |          |                             |   |    |          |                       |   |    |
| TB1815A0  | 7,93X4,75 PE<br>TRANSP. PIPE<br>(JG<br>#PE08100N)  | 2   | M          |                                       |  |      |             |     |     |          |   |    |    |          |                         |   |    |          |                             |   |    |          |              |   |    |          |                                       |   |    |          |   |       |   |          |   |   |   |          |              |       |   |          |                                      |    |    |          |  |   |    |          |                                |   |    |          |  |    |    |          |             |   |    |          |                 |   |    |          |   |   |    |          |   |   |    |          |   |   |    |          |                             |   |    |          |                       |   |    |
| TB2243A0  | Ø10 PET PIPE                                       | 1.500   | M          |                                       |  |      |             |     |     |          |   |    |    |          |                         |   |    |          |                             |   |    |          |              |   |    |          |                                       |   |    |          |   |       |   |          |   |   |   |          |              |       |   |          |                                      |    |    |          |  |   |    |          |                                |   |    |          |  |    |    |          |             |   |    |          |                 |   |    |          |   |   |    |          |   |   |    |          |   |   |    |          |                             |   |    |          |                       |   |    |
| VI1220A1  | 4,2X12 TCB<br>SELF-TAPPIN<br>G SCREW               | 16  | PZ         |                                       |  |      |             |     |     |          |   |    |    |          |                         |   |    |          |                             |   |    |          |              |   |    |          |                                       |   |    |          |   |       |   |          |   |   |   |          |              |       |   |          |                                      |    |    |          |  |   |    |          |                                |   |    |          |  |    |    |          |             |   |    |          |                 |   |    |          |   |   |    |          |   |   |    |          |   |   |    |          |                             |   |    |          |                       |   |    |
| VI1895A0  | BLIND NUT M4<br>STAINLESS<br>STEEL DIN 917         | 8   | PZ         |                                       |  |      |             |     |     |          |   |    |    |          |                         |   |    |          |                             |   |    |          |              |   |    |          |                                       |   |    |          |   |       |   |          |   |   |   |          |              |       |   |          |                                      |    |    |          |  |   |    |          |                                |   |    |          |  |    |    |          |             |   |    |          |                 |   |    |          |   |   |    |          |   |   |    |          |   |   |    |          |                             |   |    |          |                       |   |    |
| VI1945A0  | ENG-VITE<br>M4X20 TCB+<br>INOX                     | 8   | PZ         |                                       |  |      |             |     |     |          |   |    |    |          |                         |   |    |          |                             |   |    |          |              |   |    |          |                                       |   |    |          |   |       |   |          |   |   |   |          |              |       |   |          |                                      |    |    |          |  |   |    |          |                                |   |    |          |  |    |    |          |             |   |    |          |                 |   |    |          |   |   |    |          |   |   |    |          |   |   |    |          |                             |   |    |          |                       |   |    |
| VI1950A0  | ST. STEEL<br>4,2X13 TCB<br>SELF-DRILLIN<br>G SCREW | 10  | PZ         |                                       |  |      |             |     |     |          |   |    |    |          |                         |   |    |          |                             |   |    |          |              |   |    |          |                                       |   |    |          |   |       |   |          |   |   |   |          |              |       |   |          |                                      |    |    |          |  |   |    |          |                                |   |    |          |  |    |    |          |             |   |    |          |                 |   |    |          |   |   |    |          |   |   |    |          |   |   |    |          |                             |   |    |          |                       |   |    |
| VL1005A1  | U-TRAP TANK  | 2   | PZ         |                                       |  |      |             |     |     |          |   |    |    |          |                         |   |    |          |                             |   |    |          |              |   |    |          |                                       |   |    |          |   |       |   |          |   |   |   |          |              |       |   |          |                                      |    |    |          |  |   |    |          |                                |   |    |          |  |    |    |          |             |   |    |          |                 |   |    |          |   |   |    |          |   |   |    |          |   |   |    |          |                             |   |    |          |                       |   |    |
| VL1006A0  | SYPHON<br>COVER                                    | 2   | PZ         |                                       |  |      |             |     |     |          |   |    |    |          |                         |   |    |          |                             |   |    |          |              |   |    |          |                                       |   |    |          |   |       |   |          |   |   |   |          |              |       |   |          |                                      |    |    |          |  |   |    |          |                                |   |    |          |  |    |    |          |             |   |    |          |                 |   |    |          |   |   |    |          |   |   |    |          |   |   |    |          |                             |   |    |          |                       |   |    |
| VL1046A1  | D6 PIPE<br>HOLDER - D6<br>J.G. TERMINAL            | 6   | PZ         |                                       |  |      |             |     |     |          |   |    |    |          |                         |   |    |          |                             |   |    |          |              |   |    |          |                                       |   |    |          |   |       |   |          |   |   |   |          |              |       |   |          |                                      |    |    |          |  |   |    |          |                                |   |    |          |  |    |    |          |             |   |    |          |                 |   |    |          |   |   |    |          |   |   |    |          |   |   |    |          |                             |   |    |          |                       |   |    |
| VL1047A1  | D6 PIPE<br>HOLDER - D8<br>J.G. TERMINAL            | 2   | PZ         |                                       |  |      |             |     |     |          |   |    |    |          |                         |   |    |          |                             |   |    |          |              |   |    |          |                                       |   |    |          |   |       |   |          |   |   |   |          |              |       |   |          |                                      |    |    |          |  |   |    |          |                                |   |    |          |  |    |    |          |             |   |    |          |                 |   |    |          |   |   |    |          |   |   |    |          |   |   |    |          |                             |   |    |          |                       |   |    |
| VM1015A1  | STAINLESS<br>STEEL<br>Ø30X1.5 90°<br>BEND          | 1   | PZ         |                                       |  |      |             |     |     |          |   |    |    |          |                         |   |    |          |                             |   |    |          |              |   |    |          |                                       |   |    |          |   |       |   |          |   |   |   |          |              |       |   |          |                                      |    |    |          |  |   |    |          |                                |   |    |          |  |    |    |          |             |   |    |          |                 |   |    |          |   |   |    |          |   |   |    |          |   |   |    |          |                             |   |    |          |                       |   |    |
| VM1794A0  | 250X4.8 PA66<br>BLACK CLAMP                        | 2   | PZ         |                                       |  |      |             |     |     |          |   |    |    |          |                         |   |    |          |                             |   |    |          |              |   |    |          |                                       |   |    |          |   |       |   |          |   |   |   |          |              |       |   |          |                                      |    |    |          |  |   |    |          |                                |   |    |          |  |    |    |          |             |   |    |          |                 |   |    |          |   |   |    |          |   |   |    |          |   |   |    |          |                             |   |    |          |                       |   |    |
| VM2035A0  | DRAIN PIPE<br>SUPPORT                              | 1   | PZ         |                                       |  |      |             |     |     |          |   |    |    |          |                         |   |    |          |                             |   |    |          |              |   |    |          |                                       |   |    |          |   |       |   |          |   |   |   |          |              |       |   |          |                                      |    |    |          |  |   |    |          |                                |   |    |          |  |    |    |          |             |   |    |          |                 |   |    |          |   |   |    |          |   |   |    |          |   |   |    |          |                             |   |    |          |                       |   |    |

| COMPONENT |   |   | SPARE PART |                                     |  |      |             |     |     |          |                              |   |    |          |                       |   |    |          |                            |   |    |          |                             |   |    |          |                                   |   |    |          |                            |   |    |          |                        |   |    |          |                 |   |    |          |                                      |   |    |          |                      |   |    |          |                         |   |    |          |              |   |    |          |  |       |   |          |  |   |   |          |              |       |   |          |                                |   |    |          |                                      |   |    |          |                          |   |    |          |   |   |    |
|-----------|---|---|------------|-------------------------------------|--|------|-------------|-----|-----|----------|------------------------------|---|----|----------|-----------------------|---|----|----------|----------------------------|---|----|----------|-----------------------------|---|----|----------|-----------------------------------|---|----|----------|----------------------------|---|----|----------|------------------------|---|----|----------|-----------------|---|----|----------|--------------------------------------|---|----|----------|----------------------|---|----|----------|-------------------------|---|----|----------|--------------|---|----|----------|--|-------|---|----------|--|---|---|----------|--------------|-------|---|----------|--------------------------------|---|----|----------|--------------------------------------|---|----|----------|--------------------------|---|----|----------|---|---|----|
| Code      | Description                               | Image   | Code       | Description                         | Components list  |      |             |     |     |          |                              |   |    |          |                       |   |    |          |                            |   |    |          |                             |   |    |          |                                   |   |    |          |                            |   |    |          |                        |   |    |          |                 |   |    |          |                                      |   |    |          |                      |   |    |          |                         |   |    |          |              |   |    |          |  |       |   |          |  |   |   |          |              |       |   |          |                                |   |    |          |                                      |   |    |          |                          |   |    |          |   |   |    |
| VL1005A   | U-TRAP TANK                               |  | XC649      | LINEMISS TOP FULL SIZE STACKING KIT | <table border="1"> <thead> <tr> <th>Code</th> <th>Description</th> <th>Qty</th> <th>UOM</th> </tr> </thead> <tbody> <tr> <td>0H1151A0</td> <td>PROOFER-OV EN FIXING BRACKET</td> <td>4</td> <td>PZ</td> </tr> <tr> <td>0H1237A0</td> <td>LM TOP SIPHON SUPPORT</td> <td>2</td> <td>PZ</td> </tr> <tr> <td>ED1335A0</td> <td>CAUTION HOT TRIANGLE LABEL</td> <td>1</td> <td>PZ</td> </tr> <tr> <td>ED1338A0</td> <td>UL LIQUID FALLS DANGER LABE</td> <td>1</td> <td>PZ</td> </tr> <tr> <td>EL1020A1</td> <td>D8 INTERMEDIAT E T-SHAPED FITTING</td> <td>2</td> <td>PZ</td> </tr> <tr> <td>EL1185A0</td> <td>Ø8F - Ø8F ELBOW CONNECTION</td> <td>2</td> <td>PZ</td> </tr> <tr> <td>GN1508A0</td> <td>O-RING GASKET COD 2400</td> <td>2</td> <td>PZ</td> </tr> <tr> <td>RC1008A0</td> <td>D9 ELASTIC CLIP</td> <td>3</td> <td>PZ</td> </tr> <tr> <td>RC1055A0</td> <td>Ø25-40 H12 STAINLESS STEEL PIPE CLIP</td> <td>8</td> <td>PZ</td> </tr> <tr> <td>RC1297A1</td> <td>D10 T-SHAPED FITTING</td> <td>1</td> <td>PZ</td> </tr> <tr> <td>RC1360A0</td> <td>10 - 10 JG ELBOW FITTIN</td> <td>1</td> <td>PZ</td> </tr> <tr> <td>RC1376A0</td> <td>Ø6 Y-FITTING</td> <td>1</td> <td>PZ</td> </tr> <tr> <td>TB1520A0</td> <td>INT. Ø=38 TH=4 DRAIN BLACK RUBBER PIPE</td> <td>2.840</td> <td>M</td> </tr> <tr> <td>TB1815A0</td> <td>7,93X4,75 PE TRANSP. PIPE (JG #PE08100N)</td> <td>2</td> <td>M</td> </tr> <tr> <td>TB2243A0</td> <td>Ø10 PET PIPE</td> <td>1.500</td> <td>M</td> </tr> <tr> <td>VI1220A1</td> <td>4,2X12 TCB SELF-TAPPIN G SCREW</td> <td>7</td> <td>PZ</td> </tr> <tr> <td>VI1895A0</td> <td>BLIND NUT M4 STAINLESS STEEL DIN 917</td> <td>8</td> <td>PZ</td> </tr> <tr> <td>VI1945A0</td> <td>ENG-VITE M4X20 TCB+ INOX</td> <td>8</td> <td>PZ</td> </tr> <tr> <td>VI1950A0</td> <td>ST. STEEL 4,2X13 TCB SELF-DRILLIN G SCREW</td> <td>6</td> <td>PZ</td> </tr> </tbody> </table> | Code | Description | Qty | UOM | 0H1151A0 | PROOFER-OV EN FIXING BRACKET | 4 | PZ | 0H1237A0 | LM TOP SIPHON SUPPORT | 2 | PZ | ED1335A0 | CAUTION HOT TRIANGLE LABEL | 1 | PZ | ED1338A0 | UL LIQUID FALLS DANGER LABE | 1 | PZ | EL1020A1 | D8 INTERMEDIAT E T-SHAPED FITTING | 2 | PZ | EL1185A0 | Ø8F - Ø8F ELBOW CONNECTION | 2 | PZ | GN1508A0 | O-RING GASKET COD 2400 | 2 | PZ | RC1008A0 | D9 ELASTIC CLIP | 3 | PZ | RC1055A0 | Ø25-40 H12 STAINLESS STEEL PIPE CLIP | 8 | PZ | RC1297A1 | D10 T-SHAPED FITTING | 1 | PZ | RC1360A0 | 10 - 10 JG ELBOW FITTIN | 1 | PZ | RC1376A0 | Ø6 Y-FITTING | 1 | PZ | TB1520A0 | INT. Ø=38 TH=4 DRAIN BLACK RUBBER PIPE | 2.840 | M | TB1815A0 | 7,93X4,75 PE TRANSP. PIPE (JG #PE08100N) | 2 | M | TB2243A0 | Ø10 PET PIPE | 1.500 | M | VI1220A1 | 4,2X12 TCB SELF-TAPPIN G SCREW | 7 | PZ | VI1895A0 | BLIND NUT M4 STAINLESS STEEL DIN 917 | 8 | PZ | VI1945A0 | ENG-VITE M4X20 TCB+ INOX | 8 | PZ | VI1950A0 | ST. STEEL 4,2X13 TCB SELF-DRILLIN G SCREW | 6 | PZ |
| Code      | Description                               | Qty   | UOM        |                                     |  |      |             |     |     |          |                              |   |    |          |                       |   |    |          |                            |   |    |          |                             |   |    |          |                                   |   |    |          |                            |   |    |          |                        |   |    |          |                 |   |    |          |                                      |   |    |          |                      |   |    |          |                         |   |    |          |              |   |    |          |  |       |   |          |  |   |   |          |              |       |   |          |                                |   |    |          |                                      |   |    |          |                          |   |    |          |   |   |    |
| 0H1151A0  | PROOFER-OV EN FIXING BRACKET              | 4   | PZ         |                                     |  |      |             |     |     |          |                              |   |    |          |                       |   |    |          |                            |   |    |          |                             |   |    |          |                                   |   |    |          |                            |   |    |          |                        |   |    |          |                 |   |    |          |                                      |   |    |          |                      |   |    |          |                         |   |    |          |              |   |    |          |  |       |   |          |  |   |   |          |              |       |   |          |                                |   |    |          |                                      |   |    |          |                          |   |    |          |   |   |    |
| 0H1237A0  | LM TOP SIPHON SUPPORT                     | 2   | PZ         |                                     |  |      |             |     |     |          |                              |   |    |          |                       |   |    |          |                            |   |    |          |                             |   |    |          |                                   |   |    |          |                            |   |    |          |                        |   |    |          |                 |   |    |          |                                      |   |    |          |                      |   |    |          |                         |   |    |          |              |   |    |          |  |       |   |          |  |   |   |          |              |       |   |          |                                |   |    |          |                                      |   |    |          |                          |   |    |          |   |   |    |
| ED1335A0  | CAUTION HOT TRIANGLE LABEL                | 1   | PZ         |                                     |  |      |             |     |     |          |                              |   |    |          |                       |   |    |          |                            |   |    |          |                             |   |    |          |                                   |   |    |          |                            |   |    |          |                        |   |    |          |                 |   |    |          |                                      |   |    |          |                      |   |    |          |                         |   |    |          |              |   |    |          |  |       |   |          |  |   |   |          |              |       |   |          |                                |   |    |          |                                      |   |    |          |                          |   |    |          |   |   |    |
| ED1338A0  | UL LIQUID FALLS DANGER LABE               | 1   | PZ         |                                     |  |      |             |     |     |          |                              |   |    |          |                       |   |    |          |                            |   |    |          |                             |   |    |          |                                   |   |    |          |                            |   |    |          |                        |   |    |          |                 |   |    |          |                                      |   |    |          |                      |   |    |          |                         |   |    |          |              |   |    |          |  |       |   |          |  |   |   |          |              |       |   |          |                                |   |    |          |                                      |   |    |          |                          |   |    |          |   |   |    |
| EL1020A1  | D8 INTERMEDIAT E T-SHAPED FITTING         | 2   | PZ         |                                     |  |      |             |     |     |          |                              |   |    |          |                       |   |    |          |                            |   |    |          |                             |   |    |          |                                   |   |    |          |                            |   |    |          |                        |   |    |          |                 |   |    |          |                                      |   |    |          |                      |   |    |          |                         |   |    |          |              |   |    |          |  |       |   |          |  |   |   |          |              |       |   |          |                                |   |    |          |                                      |   |    |          |                          |   |    |          |   |   |    |
| EL1185A0  | Ø8F - Ø8F ELBOW CONNECTION                | 2   | PZ         |                                     |  |      |             |     |     |          |                              |   |    |          |                       |   |    |          |                            |   |    |          |                             |   |    |          |                                   |   |    |          |                            |   |    |          |                        |   |    |          |                 |   |    |          |                                      |   |    |          |                      |   |    |          |                         |   |    |          |              |   |    |          |  |       |   |          |  |   |   |          |              |       |   |          |                                |   |    |          |                                      |   |    |          |                          |   |    |          |   |   |    |
| GN1508A0  | O-RING GASKET COD 2400                    | 2   | PZ         |                                     |  |      |             |     |     |          |                              |   |    |          |                       |   |    |          |                            |   |    |          |                             |   |    |          |                                   |   |    |          |                            |   |    |          |                        |   |    |          |                 |   |    |          |                                      |   |    |          |                      |   |    |          |                         |   |    |          |              |   |    |          |  |       |   |          |  |   |   |          |              |       |   |          |                                |   |    |          |                                      |   |    |          |                          |   |    |          |   |   |    |
| RC1008A0  | D9 ELASTIC CLIP                           | 3   | PZ         |                                     |  |      |             |     |     |          |                              |   |    |          |                       |   |    |          |                            |   |    |          |                             |   |    |          |                                   |   |    |          |                            |   |    |          |                        |   |    |          |                 |   |    |          |                                      |   |    |          |                      |   |    |          |                         |   |    |          |              |   |    |          |  |       |   |          |  |   |   |          |              |       |   |          |                                |   |    |          |                                      |   |    |          |                          |   |    |          |   |   |    |
| RC1055A0  | Ø25-40 H12 STAINLESS STEEL PIPE CLIP      | 8   | PZ         |                                     |  |      |             |     |     |          |                              |   |    |          |                       |   |    |          |                            |   |    |          |                             |   |    |          |                                   |   |    |          |                            |   |    |          |                        |   |    |          |                 |   |    |          |                                      |   |    |          |                      |   |    |          |                         |   |    |          |              |   |    |          |  |       |   |          |  |   |   |          |              |       |   |          |                                |   |    |          |                                      |   |    |          |                          |   |    |          |   |   |    |
| RC1297A1  | D10 T-SHAPED FITTING                      | 1   | PZ         |                                     |  |      |             |     |     |          |                              |   |    |          |                       |   |    |          |                            |   |    |          |                             |   |    |          |                                   |   |    |          |                            |   |    |          |                        |   |    |          |                 |   |    |          |                                      |   |    |          |                      |   |    |          |                         |   |    |          |              |   |    |          |  |       |   |          |  |   |   |          |              |       |   |          |                                |   |    |          |                                      |   |    |          |                          |   |    |          |   |   |    |
| RC1360A0  | 10 - 10 JG ELBOW FITTIN                   | 1   | PZ         |                                     |  |      |             |     |     |          |                              |   |    |          |                       |   |    |          |                            |   |    |          |                             |   |    |          |                                   |   |    |          |                            |   |    |          |                        |   |    |          |                 |   |    |          |                                      |   |    |          |                      |   |    |          |                         |   |    |          |              |   |    |          |  |       |   |          |  |   |   |          |              |       |   |          |                                |   |    |          |                                      |   |    |          |                          |   |    |          |   |   |    |
| RC1376A0  | Ø6 Y-FITTING                              | 1   | PZ         |                                     |  |      |             |     |     |          |                              |   |    |          |                       |   |    |          |                            |   |    |          |                             |   |    |          |                                   |   |    |          |                            |   |    |          |                        |   |    |          |                 |   |    |          |                                      |   |    |          |                      |   |    |          |                         |   |    |          |              |   |    |          |  |       |   |          |  |   |   |          |              |       |   |          |                                |   |    |          |                                      |   |    |          |                          |   |    |          |   |   |    |
| TB1520A0  | INT. Ø=38 TH=4 DRAIN BLACK RUBBER PIPE    | 2.840   | M          |                                     |  |      |             |     |     |          |                              |   |    |          |                       |   |    |          |                            |   |    |          |                             |   |    |          |                                   |   |    |          |                            |   |    |          |                        |   |    |          |                 |   |    |          |                                      |   |    |          |                      |   |    |          |                         |   |    |          |              |   |    |          |  |       |   |          |  |   |   |          |              |       |   |          |                                |   |    |          |                                      |   |    |          |                          |   |    |          |   |   |    |
| TB1815A0  | 7,93X4,75 PE TRANSP. PIPE (JG #PE08100N)  | 2   | M          |                                     |  |      |             |     |     |          |                              |   |    |          |                       |   |    |          |                            |   |    |          |                             |   |    |          |                                   |   |    |          |                            |   |    |          |                        |   |    |          |                 |   |    |          |                                      |   |    |          |                      |   |    |          |                         |   |    |          |              |   |    |          |  |       |   |          |  |   |   |          |              |       |   |          |                                |   |    |          |                                      |   |    |          |                          |   |    |          |   |   |    |
| TB2243A0  | Ø10 PET PIPE                              | 1.500   | M          |                                     |  |      |             |     |     |          |                              |   |    |          |                       |   |    |          |                            |   |    |          |                             |   |    |          |                                   |   |    |          |                            |   |    |          |                        |   |    |          |                 |   |    |          |                                      |   |    |          |                      |   |    |          |                         |   |    |          |              |   |    |          |  |       |   |          |  |   |   |          |              |       |   |          |                                |   |    |          |                                      |   |    |          |                          |   |    |          |   |   |    |
| VI1220A1  | 4,2X12 TCB SELF-TAPPIN G SCREW            | 7   | PZ         |                                     |  |      |             |     |     |          |                              |   |    |          |                       |   |    |          |                            |   |    |          |                             |   |    |          |                                   |   |    |          |                            |   |    |          |                        |   |    |          |                 |   |    |          |                                      |   |    |          |                      |   |    |          |                         |   |    |          |              |   |    |          |  |       |   |          |  |   |   |          |              |       |   |          |                                |   |    |          |                                      |   |    |          |                          |   |    |          |   |   |    |
| VI1895A0  | BLIND NUT M4 STAINLESS STEEL DIN 917      | 8   | PZ         |                                     |  |      |             |     |     |          |                              |   |    |          |                       |   |    |          |                            |   |    |          |                             |   |    |          |                                   |   |    |          |                            |   |    |          |                        |   |    |          |                 |   |    |          |                                      |   |    |          |                      |   |    |          |                         |   |    |          |              |   |    |          |  |       |   |          |  |   |   |          |              |       |   |          |                                |   |    |          |                                      |   |    |          |                          |   |    |          |   |   |    |
| VI1945A0  | ENG-VITE M4X20 TCB+ INOX                  | 8   | PZ         |                                     |  |      |             |     |     |          |                              |   |    |          |                       |   |    |          |                            |   |    |          |                             |   |    |          |                                   |   |    |          |                            |   |    |          |                        |   |    |          |                 |   |    |          |                                      |   |    |          |                      |   |    |          |                         |   |    |          |              |   |    |          |  |       |   |          |  |   |   |          |              |       |   |          |                                |   |    |          |                                      |   |    |          |                          |   |    |          |   |   |    |
| VI1950A0  | ST. STEEL 4,2X13 TCB SELF-DRILLIN G SCREW | 6   | PZ         |                                     |  |      |             |     |     |          |                              |   |    |          |                       |   |    |          |                            |   |    |          |                             |   |    |          |                                   |   |    |          |                            |   |    |          |                        |   |    |          |                 |   |    |          |                                      |   |    |          |                      |   |    |          |                         |   |    |          |              |   |    |          |  |       |   |          |  |   |   |          |              |       |   |          |                                |   |    |          |                                      |   |    |          |                          |   |    |          |   |   |    |



| COMPONENT |  |   | SPARE PART |                                     |   |      |             |                       |     |          |             |                                      |    |          |              |                                    |    |          |                                   |                   |    |          |                          |                          |    |          |                    |                                  |    |    |          |                                    |   |    |          |                        |   |    |          |                 |   |    |          |                                      |    |    |          |                      |   |    |          |                          |   |    |          |              |   |    |          |                                 |   |    |          |  |       |   |
|-----------|--|---|------------|-------------------------------------|---|------|-------------|-----------------------|-----|----------|-------------|--------------------------------------|----|----------|--------------|------------------------------------|----|----------|-----------------------------------|-------------------|----|----------|--------------------------|--------------------------|----|----------|--------------------|----------------------------------|----|----|----------|------------------------------------|---|----|----------|------------------------|---|----|----------|-----------------|---|----|----------|--------------------------------------|----|----|----------|----------------------|---|----|----------|--------------------------|---|----|----------|--------------|---|----|----------|---------------------------------|---|----|----------|--|-------|---|
| Code      | Description                            | Image   | Code       | Description                         | Components list   |      |             |                       |     |          |             |                                      |    |          |              |                                    |    |          |                                   |                   |    |          |                          |                          |    |          |                    |                                  |    |    |          |                                    |   |    |          |                        |   |    |          |                 |   |    |          |                                      |    |    |          |                      |   |    |          |                          |   |    |          |              |   |    |          |                                 |   |    |          |  |       |   |
| VL1005A   | U-TRAP TANK                            |    | XC649      | LINEMISS TOP FULL SIZE STACKING KIT | <table border="1"> <thead> <tr> <th>Code</th> <th>Description</th> <th>Qty</th> <th>UOM</th> </tr> </thead> <tbody> <tr> <td>VL1005A1</td> <td>U-TRAP TANK</td> <td>2</td> <td>PZ</td> </tr> <tr> <td>VL1006A0</td> <td>SYPHON COVER</td> <td>2</td> <td>PZ</td> </tr> <tr> <td>VL1046A1</td> <td>D6 PIPE HOLDER - D6 J.G. TERMINAL</td> <td>3</td> <td>PZ</td> </tr> <tr> <td>VM1794A0</td> <td>250X4.8 PA66 BLACK CLAMP</td> <td>2</td> <td>PZ</td> </tr> <tr> <td>VM2035A0</td> <td>DRAIN PIPE SUPPORT</td> <td>1</td> <td>PZ</td> </tr> </tbody> </table> | Code | Description | Qty                   | UOM | VL1005A1 | U-TRAP TANK | 2                                    | PZ | VL1006A0 | SYPHON COVER | 2                                  | PZ | VL1046A1 | D6 PIPE HOLDER - D6 J.G. TERMINAL | 3                 | PZ | VM1794A0 | 250X4.8 PA66 BLACK CLAMP | 2                        | PZ | VM2035A0 | DRAIN PIPE SUPPORT | 1                                | PZ |    |          |                                    |   |    |          |                        |   |    |          |                 |   |    |          |                                      |    |    |          |                      |   |    |          |                          |   |    |          |              |   |    |          |                                 |   |    |          |  |       |   |
|           |  |   | Code       | Description                         | Qty   | UOM  |             |                       |     |          |             |                                      |    |          |              |                                    |    |          |                                   |                   |    |          |                          |                          |    |          |                    |                                  |    |    |          |                                    |   |    |          |                        |   |    |          |                 |   |    |          |                                      |    |    |          |                      |   |    |          |                          |   |    |          |              |   |    |          |                                 |   |    |          |  |       |   |
| VL1005A1  | U-TRAP TANK                            | 2   | PZ         |                                     |   |      |             |                       |     |          |             |                                      |    |          |              |                                    |    |          |                                   |                   |    |          |                          |                          |    |          |                    |                                  |    |    |          |                                    |   |    |          |                        |   |    |          |                 |   |    |          |                                      |    |    |          |                      |   |    |          |                          |   |    |          |              |   |    |          |                                 |   |    |          |  |       |   |
| VL1006A0  | SYPHON COVER                           | 2   | PZ         |                                     |   |      |             |                       |     |          |             |                                      |    |          |              |                                    |    |          |                                   |                   |    |          |                          |                          |    |          |                    |                                  |    |    |          |                                    |   |    |          |                        |   |    |          |                 |   |    |          |                                      |    |    |          |                      |   |    |          |                          |   |    |          |              |   |    |          |                                 |   |    |          |  |       |   |
| VL1046A1  | D6 PIPE HOLDER - D6 J.G. TERMINAL      | 3   | PZ         |                                     |   |      |             |                       |     |          |             |                                      |    |          |              |                                    |    |          |                                   |                   |    |          |                          |                          |    |          |                    |                                  |    |    |          |                                    |   |    |          |                        |   |    |          |                 |   |    |          |                                      |    |    |          |                      |   |    |          |                          |   |    |          |              |   |    |          |                                 |   |    |          |  |       |   |
| VM1794A0  | 250X4.8 PA66 BLACK CLAMP               | 2   | PZ         |                                     |   |      |             |                       |     |          |             |                                      |    |          |              |                                    |    |          |                                   |                   |    |          |                          |                          |    |          |                    |                                  |    |    |          |                                    |   |    |          |                        |   |    |          |                 |   |    |          |                                      |    |    |          |                      |   |    |          |                          |   |    |          |              |   |    |          |                                 |   |    |          |  |       |   |
| VM2035A0  | DRAIN PIPE SUPPORT                     | 1   | PZ         |                                     |   |      |             |                       |     |          |             |                                      |    |          |              |                                    |    |          |                                   |                   |    |          |                          |                          |    |          |                    |                                  |    |    |          |                                    |   |    |          |                        |   |    |          |                 |   |    |          |                                      |    |    |          |                      |   |    |          |                          |   |    |          |              |   |    |          |                                 |   |    |          |  |       |   |
| XC648     | LINEMISS TOP XFT200 STACKING KIT       | <table border="1"> <thead> <tr> <th>Code</th> <th>Description</th> <th>Qty</th> <th>UOM</th> </tr> </thead> <tbody> <tr> <td>0H1237A0</td> <td>LM TOP SIPHON SUPPORT</td> <td>2</td> <td>PZ</td> </tr> <tr> <td>0H7082A0</td> <td>LM 800 XC STACKING KIT FRONT PROFILE</td> <td>1</td> <td>PZ</td> </tr> <tr> <td>0H7083A0</td> <td>LM 800 XC STACKING KIT BACK PROFIL</td> <td>2</td> <td>PZ</td> </tr> <tr> <td>ED1246A0</td> <td>HOT SURFACE LABEL</td> <td>1</td> <td>PZ</td> </tr> <tr> <td>ED1271A0</td> <td>LIQUID FALLS DANGER LABE</td> <td>1</td> <td>PZ</td> </tr> <tr> <td>EL1020A1</td> <td>D8 INTERMEDIATE T-SHAPED FITTING</td> <td>2</td> <td>PZ</td> </tr> <tr> <td>EL1180A0</td> <td>Ø8-Ø8 FEMALE NON-RETURN CONNECTION</td> <td>2</td> <td>PZ</td> </tr> <tr> <td>GN1508A0</td> <td>O-RING GASKET COD 2400</td> <td>2</td> <td>PZ</td> </tr> <tr> <td>RC1008A0</td> <td>D9 ELASTIC CLIP</td> <td>7</td> <td>PZ</td> </tr> <tr> <td>RC1055A0</td> <td>Ø25-40 H12 STAINLESS STEEL PIPE CLIP</td> <td>10</td> <td>PZ</td> </tr> <tr> <td>RC1297A1</td> <td>D10 T-SHAPED FITTING</td> <td>1</td> <td>PZ</td> </tr> <tr> <td>RC1360A0</td> <td>10 - 10 JG ELBOW FITTING</td> <td>1</td> <td>PZ</td> </tr> <tr> <td>RC1376A0</td> <td>Ø6 Y-FITTING</td> <td>1</td> <td>PZ</td> </tr> <tr> <td>TB1177A0</td> <td>FOOT PANEL 40X40 H58 OVERLAP LM</td> <td>4</td> <td>PZ</td> </tr> <tr> <td>TB1520A0</td> <td>INT. Ø=38 TH=4 DRAIN BLACK RUBBER PIPE</td> <td>2.700</td> <td>M</td> </tr> </tbody> </table> | Code       | Description                         | Qty   | UOM  | 0H1237A0    | LM TOP SIPHON SUPPORT | 2   | PZ       | 0H7082A0    | LM 800 XC STACKING KIT FRONT PROFILE | 1  | PZ       | 0H7083A0     | LM 800 XC STACKING KIT BACK PROFIL | 2  | PZ       | ED1246A0                          | HOT SURFACE LABEL | 1  | PZ       | ED1271A0                 | LIQUID FALLS DANGER LABE | 1  | PZ       | EL1020A1           | D8 INTERMEDIATE T-SHAPED FITTING | 2  | PZ | EL1180A0 | Ø8-Ø8 FEMALE NON-RETURN CONNECTION | 2 | PZ | GN1508A0 | O-RING GASKET COD 2400 | 2 | PZ | RC1008A0 | D9 ELASTIC CLIP | 7 | PZ | RC1055A0 | Ø25-40 H12 STAINLESS STEEL PIPE CLIP | 10 | PZ | RC1297A1 | D10 T-SHAPED FITTING | 1 | PZ | RC1360A0 | 10 - 10 JG ELBOW FITTING | 1 | PZ | RC1376A0 | Ø6 Y-FITTING | 1 | PZ | TB1177A0 | FOOT PANEL 40X40 H58 OVERLAP LM | 4 | PZ | TB1520A0 | INT. Ø=38 TH=4 DRAIN BLACK RUBBER PIPE | 2.700 | M |
| Code      | Description                            | Qty   | UOM        |                                     |   |      |             |                       |     |          |             |                                      |    |          |              |                                    |    |          |                                   |                   |    |          |                          |                          |    |          |                    |                                  |    |    |          |                                    |   |    |          |                        |   |    |          |                 |   |    |          |                                      |    |    |          |                      |   |    |          |                          |   |    |          |              |   |    |          |                                 |   |    |          |  |       |   |
| 0H1237A0  | LM TOP SIPHON SUPPORT                  | 2   | PZ         |                                     |   |      |             |                       |     |          |             |                                      |    |          |              |                                    |    |          |                                   |                   |    |          |                          |                          |    |          |                    |                                  |    |    |          |                                    |   |    |          |                        |   |    |          |                 |   |    |          |                                      |    |    |          |                      |   |    |          |                          |   |    |          |              |   |    |          |                                 |   |    |          |  |       |   |
| 0H7082A0  | LM 800 XC STACKING KIT FRONT PROFILE   | 1   | PZ         |                                     |   |      |             |                       |     |          |             |                                      |    |          |              |                                    |    |          |                                   |                   |    |          |                          |                          |    |          |                    |                                  |    |    |          |                                    |   |    |          |                        |   |    |          |                 |   |    |          |                                      |    |    |          |                      |   |    |          |                          |   |    |          |              |   |    |          |                                 |   |    |          |  |       |   |
| 0H7083A0  | LM 800 XC STACKING KIT BACK PROFIL     | 2   | PZ         |                                     |   |      |             |                       |     |          |             |                                      |    |          |              |                                    |    |          |                                   |                   |    |          |                          |                          |    |          |                    |                                  |    |    |          |                                    |   |    |          |                        |   |    |          |                 |   |    |          |                                      |    |    |          |                      |   |    |          |                          |   |    |          |              |   |    |          |                                 |   |    |          |  |       |   |
| ED1246A0  | HOT SURFACE LABEL                      | 1   | PZ         |                                     |   |      |             |                       |     |          |             |                                      |    |          |              |                                    |    |          |                                   |                   |    |          |                          |                          |    |          |                    |                                  |    |    |          |                                    |   |    |          |                        |   |    |          |                 |   |    |          |                                      |    |    |          |                      |   |    |          |                          |   |    |          |              |   |    |          |                                 |   |    |          |  |       |   |
| ED1271A0  | LIQUID FALLS DANGER LABE               | 1   | PZ         |                                     |   |      |             |                       |     |          |             |                                      |    |          |              |                                    |    |          |                                   |                   |    |          |                          |                          |    |          |                    |                                  |    |    |          |                                    |   |    |          |                        |   |    |          |                 |   |    |          |                                      |    |    |          |                      |   |    |          |                          |   |    |          |              |   |    |          |                                 |   |    |          |  |       |   |
| EL1020A1  | D8 INTERMEDIATE T-SHAPED FITTING       | 2   | PZ         |                                     |   |      |             |                       |     |          |             |                                      |    |          |              |                                    |    |          |                                   |                   |    |          |                          |                          |    |          |                    |                                  |    |    |          |                                    |   |    |          |                        |   |    |          |                 |   |    |          |                                      |    |    |          |                      |   |    |          |                          |   |    |          |              |   |    |          |                                 |   |    |          |  |       |   |
| EL1180A0  | Ø8-Ø8 FEMALE NON-RETURN CONNECTION     | 2   | PZ         |                                     |   |      |             |                       |     |          |             |                                      |    |          |              |                                    |    |          |                                   |                   |    |          |                          |                          |    |          |                    |                                  |    |    |          |                                    |   |    |          |                        |   |    |          |                 |   |    |          |                                      |    |    |          |                      |   |    |          |                          |   |    |          |              |   |    |          |                                 |   |    |          |  |       |   |
| GN1508A0  | O-RING GASKET COD 2400                 | 2   | PZ         |                                     |   |      |             |                       |     |          |             |                                      |    |          |              |                                    |    |          |                                   |                   |    |          |                          |                          |    |          |                    |                                  |    |    |          |                                    |   |    |          |                        |   |    |          |                 |   |    |          |                                      |    |    |          |                      |   |    |          |                          |   |    |          |              |   |    |          |                                 |   |    |          |  |       |   |
| RC1008A0  | D9 ELASTIC CLIP                        | 7   | PZ         |                                     |   |      |             |                       |     |          |             |                                      |    |          |              |                                    |    |          |                                   |                   |    |          |                          |                          |    |          |                    |                                  |    |    |          |                                    |   |    |          |                        |   |    |          |                 |   |    |          |                                      |    |    |          |                      |   |    |          |                          |   |    |          |              |   |    |          |                                 |   |    |          |  |       |   |
| RC1055A0  | Ø25-40 H12 STAINLESS STEEL PIPE CLIP   | 10  | PZ         |                                     |   |      |             |                       |     |          |             |                                      |    |          |              |                                    |    |          |                                   |                   |    |          |                          |                          |    |          |                    |                                  |    |    |          |                                    |   |    |          |                        |   |    |          |                 |   |    |          |                                      |    |    |          |                      |   |    |          |                          |   |    |          |              |   |    |          |                                 |   |    |          |  |       |   |
| RC1297A1  | D10 T-SHAPED FITTING                   | 1   | PZ         |                                     |   |      |             |                       |     |          |             |                                      |    |          |              |                                    |    |          |                                   |                   |    |          |                          |                          |    |          |                    |                                  |    |    |          |                                    |   |    |          |                        |   |    |          |                 |   |    |          |                                      |    |    |          |                      |   |    |          |                          |   |    |          |              |   |    |          |                                 |   |    |          |  |       |   |
| RC1360A0  | 10 - 10 JG ELBOW FITTING               | 1   | PZ         |                                     |   |      |             |                       |     |          |             |                                      |    |          |              |                                    |    |          |                                   |                   |    |          |                          |                          |    |          |                    |                                  |    |    |          |                                    |   |    |          |                        |   |    |          |                 |   |    |          |                                      |    |    |          |                      |   |    |          |                          |   |    |          |              |   |    |          |                                 |   |    |          |  |       |   |
| RC1376A0  | Ø6 Y-FITTING                           | 1   | PZ         |                                     |   |      |             |                       |     |          |             |                                      |    |          |              |                                    |    |          |                                   |                   |    |          |                          |                          |    |          |                    |                                  |    |    |          |                                    |   |    |          |                        |   |    |          |                 |   |    |          |                                      |    |    |          |                      |   |    |          |                          |   |    |          |              |   |    |          |                                 |   |    |          |  |       |   |
| TB1177A0  | FOOT PANEL 40X40 H58 OVERLAP LM        | 4   | PZ         |                                     |   |      |             |                       |     |          |             |                                      |    |          |              |                                    |    |          |                                   |                   |    |          |                          |                          |    |          |                    |                                  |    |    |          |                                    |   |    |          |                        |   |    |          |                 |   |    |          |                                      |    |    |          |                      |   |    |          |                          |   |    |          |              |   |    |          |                                 |   |    |          |  |       |   |
| TB1520A0  | INT. Ø=38 TH=4 DRAIN BLACK RUBBER PIPE | 2.700   | M          |                                     |   |      |             |                       |     |          |             |                                      |    |          |              |                                    |    |          |                                   |                   |    |          |                          |                          |    |          |                    |                                  |    |    |          |                                    |   |    |          |                        |   |    |          |                 |   |    |          |                                      |    |    |          |                      |   |    |          |                          |   |    |          |              |   |    |          |                                 |   |    |          |  |       |   |





| COMPONENT |  |   | SPARE PART |  |   |      |             |     |     |          |   |   |   |          |              |       |   |          |                                      |    |    |          |  |   |    |          |                                |   |    |          |  |    |    |          |             |   |    |          |                 |   |    |          |   |   |    |          |   |   |    |          |   |   |    |          |                             |   |    |          |                       |   |    |          |                            |  |      |             |     |     |          |                              |   |    |          |  |   |    |          |                                |   |    |          |             |   |    |          |                 |   |    |
|-----------|--|---|------------|--|---|------|-------------|-----|-----|----------|---|---|---|----------|--------------|-------|---|----------|--------------------------------------|----|----|----------|--|---|----|----------|--------------------------------|---|----|----------|--|----|----|----------|-------------|---|----|----------|-----------------|---|----|----------|---|---|----|----------|---|---|----|----------|---|---|----|----------|-----------------------------|---|----|----------|-----------------------|---|----|----------|----------------------------|--|------|-------------|-----|-----|----------|------------------------------|---|----|----------|--|---|----|----------|--------------------------------|---|----|----------|-------------|---|----|----------|-----------------|---|----|
| Code      | Description  | Image   | Code       | Description                            | Components list   |      |             |     |     |          |   |   |   |          |              |       |   |          |                                      |    |    |          |  |   |    |          |                                |   |    |          |  |    |    |          |             |   |    |          |                 |   |    |          |   |   |    |          |   |   |    |          |   |   |    |          |                             |   |    |          |                       |   |    |          |                            |  |      |             |     |     |          |                              |   |    |          |  |   |    |          |                                |   |    |          |             |   |    |          |                 |   |    |
| VL1005A   | U-TRAP TANK  |  | XC648      | LINEMISS TOP<br>XFT200 STACKING<br>KIT | <table border="1"> <thead> <tr> <th>Code</th> <th>Description</th> <th>Qty</th> <th>UOM</th> </tr> </thead> <tbody> <tr> <td>TB1815A0</td> <td>7,93X4,75 PE<br/>TRANSP. PIPE<br/>(JG<br/>#PE08100N)</td> <td>2</td> <td>M</td> </tr> <tr> <td>TB2243A0</td> <td>Ø10 PET PIPE</td> <td>1.500</td> <td>M</td> </tr> <tr> <td>VI1220A1</td> <td>4,2X12 TCB<br/>SELF-TAPPIN<br/>G SCREW</td> <td>16</td> <td>PZ</td> </tr> <tr> <td>VI1895A0</td> <td>BLIND NUT M4<br/>STAINLESS<br/>STEEL DIN 917</td> <td>8</td> <td>PZ</td> </tr> <tr> <td>VI1945A0</td> <td>ENG-VITE<br/>M4X20 TCB+<br/>INOX</td> <td>8</td> <td>PZ</td> </tr> <tr> <td>VI1950A0</td> <td>ST. STEEL<br/>4,2X13 TCB<br/>SELF-DRILLIN<br/>G SCREW</td> <td>10</td> <td>PZ</td> </tr> <tr> <td>VL1005A1</td> <td>U-TRAP TANK</td> <td>2</td> <td>PZ</td> </tr> <tr> <td>VL1006A0</td> <td>SYPHON<br/>COVER</td> <td>2</td> <td>PZ</td> </tr> <tr> <td>VL1046A1</td> <td>D6 PIPE<br/>HOLDER - D6<br/>J.G. TERMINAL</td> <td>6</td> <td>PZ</td> </tr> <tr> <td>VL1047A1</td> <td>D6 PIPE<br/>HOLDER - D8<br/>J.G. TERMINAL</td> <td>4</td> <td>PZ</td> </tr> <tr> <td>VM1015A1</td> <td>STAINLESS<br/>STEEL<br/>Ø30X1,5 90°<br/>BEND</td> <td>1</td> <td>PZ</td> </tr> <tr> <td>VM1794A0</td> <td>250X4.8 PA66<br/>BLACK CLAMP</td> <td>2</td> <td>PZ</td> </tr> <tr> <td>VM2035A0</td> <td>DRAIN PIPE<br/>SUPPORT</td> <td>1</td> <td>PZ</td> </tr> </tbody> </table> | Code | Description | Qty | UOM | TB1815A0 | 7,93X4,75 PE<br>TRANSP. PIPE<br>(JG<br>#PE08100N) | 2 | M | TB2243A0 | Ø10 PET PIPE | 1.500 | M | VI1220A1 | 4,2X12 TCB<br>SELF-TAPPIN<br>G SCREW | 16 | PZ | VI1895A0 | BLIND NUT M4<br>STAINLESS<br>STEEL DIN 917 | 8 | PZ | VI1945A0 | ENG-VITE<br>M4X20 TCB+<br>INOX | 8 | PZ | VI1950A0 | ST. STEEL<br>4,2X13 TCB<br>SELF-DRILLIN<br>G SCREW | 10 | PZ | VL1005A1 | U-TRAP TANK | 2 | PZ | VL1006A0 | SYPHON<br>COVER | 2 | PZ | VL1046A1 | D6 PIPE<br>HOLDER - D6<br>J.G. TERMINAL | 6 | PZ | VL1047A1 | D6 PIPE<br>HOLDER - D8<br>J.G. TERMINAL | 4 | PZ | VM1015A1 | STAINLESS<br>STEEL<br>Ø30X1,5 90°<br>BEND | 1 | PZ | VM1794A0 | 250X4.8 PA66<br>BLACK CLAMP | 2 | PZ | VM2035A0 | DRAIN PIPE<br>SUPPORT | 1 | PZ | KVL1005A | 5 /5E SERIES<br>U-TRAP KIT | <table border="1"> <thead> <tr> <th>Code</th> <th>Description</th> <th>Qty</th> <th>UOM</th> </tr> </thead> <tbody> <tr> <td>GN1508A0</td> <td>O-RING<br/>GASKET COD<br/>2400</td> <td>1</td> <td>PZ</td> </tr> <tr> <td>VI1895A0</td> <td>BLIND NUT M4<br/>STAINLESS<br/>STEEL DIN 917</td> <td>4</td> <td>PZ</td> </tr> <tr> <td>VI1945A0</td> <td>ENG-VITE<br/>M4X20 TCB+<br/>INOX</td> <td>4</td> <td>PZ</td> </tr> <tr> <td>VL1005A1</td> <td>U-TRAP TANK</td> <td>1</td> <td>PZ</td> </tr> <tr> <td>VL1006A0</td> <td>SYPHON<br/>COVER</td> <td>1</td> <td>PZ</td> </tr> </tbody> </table> | Code | Description | Qty | UOM | GN1508A0 | O-RING<br>GASKET COD<br>2400 | 1 | PZ | VI1895A0 | BLIND NUT M4<br>STAINLESS<br>STEEL DIN 917 | 4 | PZ | VI1945A0 | ENG-VITE<br>M4X20 TCB+<br>INOX | 4 | PZ | VL1005A1 | U-TRAP TANK | 1 | PZ | VL1006A0 | SYPHON<br>COVER | 1 | PZ |
|           |  |   | Code       | Description                            | Qty   | UOM  |             |     |     |          |   |   |   |          |              |       |   |          |                                      |    |    |          |  |   |    |          |                                |   |    |          |  |    |    |          |             |   |    |          |                 |   |    |          |   |   |    |          |   |   |    |          |   |   |    |          |                             |   |    |          |                       |   |    |          |                            |  |      |             |     |     |          |                              |   |    |          |  |   |    |          |                                |   |    |          |             |   |    |          |                 |   |    |
| TB1815A0  | 7,93X4,75 PE<br>TRANSP. PIPE<br>(JG<br>#PE08100N)  | 2   | M          |  |   |      |             |     |     |          |   |   |   |          |              |       |   |          |                                      |    |    |          |  |   |    |          |                                |   |    |          |  |    |    |          |             |   |    |          |                 |   |    |          |   |   |    |          |   |   |    |          |   |   |    |          |                             |   |    |          |                       |   |    |          |                            |  |      |             |     |     |          |                              |   |    |          |  |   |    |          |                                |   |    |          |             |   |    |          |                 |   |    |
| TB2243A0  | Ø10 PET PIPE                                       | 1.500   | M          |  |   |      |             |     |     |          |   |   |   |          |              |       |   |          |                                      |    |    |          |  |   |    |          |                                |   |    |          |  |    |    |          |             |   |    |          |                 |   |    |          |   |   |    |          |   |   |    |          |   |   |    |          |                             |   |    |          |                       |   |    |          |                            |  |      |             |     |     |          |                              |   |    |          |  |   |    |          |                                |   |    |          |             |   |    |          |                 |   |    |
| VI1220A1  | 4,2X12 TCB<br>SELF-TAPPIN<br>G SCREW               | 16  | PZ         |  |   |      |             |     |     |          |   |   |   |          |              |       |   |          |                                      |    |    |          |  |   |    |          |                                |   |    |          |  |    |    |          |             |   |    |          |                 |   |    |          |   |   |    |          |   |   |    |          |   |   |    |          |                             |   |    |          |                       |   |    |          |                            |  |      |             |     |     |          |                              |   |    |          |  |   |    |          |                                |   |    |          |             |   |    |          |                 |   |    |
| VI1895A0  | BLIND NUT M4<br>STAINLESS<br>STEEL DIN 917         | 8   | PZ         |  |   |      |             |     |     |          |   |   |   |          |              |       |   |          |                                      |    |    |          |  |   |    |          |                                |   |    |          |  |    |    |          |             |   |    |          |                 |   |    |          |   |   |    |          |   |   |    |          |   |   |    |          |                             |   |    |          |                       |   |    |          |                            |  |      |             |     |     |          |                              |   |    |          |  |   |    |          |                                |   |    |          |             |   |    |          |                 |   |    |
| VI1945A0  | ENG-VITE<br>M4X20 TCB+<br>INOX                     | 8   | PZ         |  |   |      |             |     |     |          |   |   |   |          |              |       |   |          |                                      |    |    |          |  |   |    |          |                                |   |    |          |  |    |    |          |             |   |    |          |                 |   |    |          |   |   |    |          |   |   |    |          |   |   |    |          |                             |   |    |          |                       |   |    |          |                            |  |      |             |     |     |          |                              |   |    |          |  |   |    |          |                                |   |    |          |             |   |    |          |                 |   |    |
| VI1950A0  | ST. STEEL<br>4,2X13 TCB<br>SELF-DRILLIN<br>G SCREW | 10  | PZ         |  |   |      |             |     |     |          |   |   |   |          |              |       |   |          |                                      |    |    |          |  |   |    |          |                                |   |    |          |  |    |    |          |             |   |    |          |                 |   |    |          |   |   |    |          |   |   |    |          |   |   |    |          |                             |   |    |          |                       |   |    |          |                            |  |      |             |     |     |          |                              |   |    |          |  |   |    |          |                                |   |    |          |             |   |    |          |                 |   |    |
| VL1005A1  | U-TRAP TANK  | 2   | PZ         |  |   |      |             |     |     |          |   |   |   |          |              |       |   |          |                                      |    |    |          |  |   |    |          |                                |   |    |          |  |    |    |          |             |   |    |          |                 |   |    |          |   |   |    |          |   |   |    |          |   |   |    |          |                             |   |    |          |                       |   |    |          |                            |  |      |             |     |     |          |                              |   |    |          |  |   |    |          |                                |   |    |          |             |   |    |          |                 |   |    |
| VL1006A0  | SYPHON<br>COVER                                    | 2   | PZ         |  |   |      |             |     |     |          |   |   |   |          |              |       |   |          |                                      |    |    |          |  |   |    |          |                                |   |    |          |  |    |    |          |             |   |    |          |                 |   |    |          |   |   |    |          |   |   |    |          |   |   |    |          |                             |   |    |          |                       |   |    |          |                            |  |      |             |     |     |          |                              |   |    |          |  |   |    |          |                                |   |    |          |             |   |    |          |                 |   |    |
| VL1046A1  | D6 PIPE<br>HOLDER - D6<br>J.G. TERMINAL            | 6   | PZ         |  |   |      |             |     |     |          |   |   |   |          |              |       |   |          |                                      |    |    |          |  |   |    |          |                                |   |    |          |  |    |    |          |             |   |    |          |                 |   |    |          |   |   |    |          |   |   |    |          |   |   |    |          |                             |   |    |          |                       |   |    |          |                            |  |      |             |     |     |          |                              |   |    |          |  |   |    |          |                                |   |    |          |             |   |    |          |                 |   |    |
| VL1047A1  | D6 PIPE<br>HOLDER - D8<br>J.G. TERMINAL            | 4   | PZ         |  |   |      |             |     |     |          |   |   |   |          |              |       |   |          |                                      |    |    |          |  |   |    |          |                                |   |    |          |  |    |    |          |             |   |    |          |                 |   |    |          |   |   |    |          |   |   |    |          |   |   |    |          |                             |   |    |          |                       |   |    |          |                            |  |      |             |     |     |          |                              |   |    |          |  |   |    |          |                                |   |    |          |             |   |    |          |                 |   |    |
| VM1015A1  | STAINLESS<br>STEEL<br>Ø30X1,5 90°<br>BEND          | 1   | PZ         |  |   |      |             |     |     |          |   |   |   |          |              |       |   |          |                                      |    |    |          |  |   |    |          |                                |   |    |          |  |    |    |          |             |   |    |          |                 |   |    |          |   |   |    |          |   |   |    |          |   |   |    |          |                             |   |    |          |                       |   |    |          |                            |  |      |             |     |     |          |                              |   |    |          |  |   |    |          |                                |   |    |          |             |   |    |          |                 |   |    |
| VM1794A0  | 250X4.8 PA66<br>BLACK CLAMP                        | 2   | PZ         |  |   |      |             |     |     |          |   |   |   |          |              |       |   |          |                                      |    |    |          |  |   |    |          |                                |   |    |          |  |    |    |          |             |   |    |          |                 |   |    |          |   |   |    |          |   |   |    |          |   |   |    |          |                             |   |    |          |                       |   |    |          |                            |  |      |             |     |     |          |                              |   |    |          |  |   |    |          |                                |   |    |          |             |   |    |          |                 |   |    |
| VM2035A0  | DRAIN PIPE<br>SUPPORT                              | 1   | PZ         |  |   |      |             |     |     |          |   |   |   |          |              |       |   |          |                                      |    |    |          |  |   |    |          |                                |   |    |          |  |    |    |          |             |   |    |          |                 |   |    |          |   |   |    |          |   |   |    |          |   |   |    |          |                             |   |    |          |                       |   |    |          |                            |  |      |             |     |     |          |                              |   |    |          |  |   |    |          |                                |   |    |          |             |   |    |          |                 |   |    |
| Code      | Description  | Qty   | UOM        |  |   |      |             |     |     |          |   |   |   |          |              |       |   |          |                                      |    |    |          |  |   |    |          |                                |   |    |          |  |    |    |          |             |   |    |          |                 |   |    |          |   |   |    |          |   |   |    |          |   |   |    |          |                             |   |    |          |                       |   |    |          |                            |  |      |             |     |     |          |                              |   |    |          |  |   |    |          |                                |   |    |          |             |   |    |          |                 |   |    |
| GN1508A0  | O-RING<br>GASKET COD<br>2400                       | 1   | PZ         |  |   |      |             |     |     |          |   |   |   |          |              |       |   |          |                                      |    |    |          |  |   |    |          |                                |   |    |          |  |    |    |          |             |   |    |          |                 |   |    |          |   |   |    |          |   |   |    |          |   |   |    |          |                             |   |    |          |                       |   |    |          |                            |  |      |             |     |     |          |                              |   |    |          |  |   |    |          |                                |   |    |          |             |   |    |          |                 |   |    |
| VI1895A0  | BLIND NUT M4<br>STAINLESS<br>STEEL DIN 917         | 4   | PZ         |  |   |      |             |     |     |          |   |   |   |          |              |       |   |          |                                      |    |    |          |  |   |    |          |                                |   |    |          |  |    |    |          |             |   |    |          |                 |   |    |          |   |   |    |          |   |   |    |          |   |   |    |          |                             |   |    |          |                       |   |    |          |                            |  |      |             |     |     |          |                              |   |    |          |  |   |    |          |                                |   |    |          |             |   |    |          |                 |   |    |
| VI1945A0  | ENG-VITE<br>M4X20 TCB+<br>INOX                     | 4   | PZ         |  |   |      |             |     |     |          |   |   |   |          |              |       |   |          |                                      |    |    |          |  |   |    |          |                                |   |    |          |  |    |    |          |             |   |    |          |                 |   |    |          |   |   |    |          |   |   |    |          |   |   |    |          |                             |   |    |          |                       |   |    |          |                            |  |      |             |     |     |          |                              |   |    |          |  |   |    |          |                                |   |    |          |             |   |    |          |                 |   |    |
| VL1005A1  | U-TRAP TANK  | 1   | PZ         |  |   |      |             |     |     |          |   |   |   |          |              |       |   |          |                                      |    |    |          |  |   |    |          |                                |   |    |          |  |    |    |          |             |   |    |          |                 |   |    |          |   |   |    |          |   |   |    |          |   |   |    |          |                             |   |    |          |                       |   |    |          |                            |  |      |             |     |     |          |                              |   |    |          |  |   |    |          |                                |   |    |          |             |   |    |          |                 |   |    |
| VL1006A0  | SYPHON<br>COVER                                    | 1   | PZ         |  |   |      |             |     |     |          |   |   |   |          |              |       |   |          |                                      |    |    |          |  |   |    |          |                                |   |    |          |  |    |    |          |             |   |    |          |                 |   |    |          |   |   |    |          |   |   |    |          |   |   |    |          |                             |   |    |          |                       |   |    |          |                            |  |      |             |     |     |          |                              |   |    |          |  |   |    |          |                                |   |    |          |             |   |    |          |                 |   |    |

| COMPONENT |  |   | SPARE PART |                                 |   |      |             |     |     |          |                            |   |    |          |                              |   |    |          |                        |       |    |          |   |   |    |          |   |       |   |          |                                      |   |    |          |  |   |    |          |                                |   |    |          |  |   |    |          |             |   |    |          |                 |   |    |          |   |   |    |       |  |   |      |             |     |     |          |                             |   |    |          |   |   |    |          |  |   |    |          |                      |   |    |          |                             |   |    |
|-----------|--|---|------------|---------------------------------|---|------|-------------|-----|-----|----------|----------------------------|---|----|----------|------------------------------|---|----|----------|------------------------|-------|----|----------|---|---|----|----------|---|-------|---|----------|--------------------------------------|---|----|----------|--|---|----|----------|--------------------------------|---|----|----------|--|---|----|----------|-------------|---|----|----------|-----------------|---|----|----------|---|---|----|-------|--|---|------|-------------|-----|-----|----------|-----------------------------|---|----|----------|---|---|----|----------|--|---|----|----------|----------------------|---|----|----------|-----------------------------|---|----|
| Code      | Description  | Image   | Code       | Description                     | Components list   |      |             |     |     |          |                            |   |    |          |                              |   |    |          |                        |       |    |          |   |   |    |          |   |       |   |          |                                      |   |    |          |  |   |    |          |                                |   |    |          |  |   |    |          |             |   |    |          |                 |   |    |          |   |   |    |       |  |   |      |             |     |     |          |                             |   |    |          |   |   |    |          |  |   |    |          |                      |   |    |          |                             |   |    |
| VL1006A   | SYPHON COVER                                       |  | XUC001     | SINGLE UNIT<br>INSTALLATION KIT | <table border="1"> <thead> <tr> <th>Code</th> <th>Description</th> <th>Qty</th> <th>UOM</th> </tr> </thead> <tbody> <tr> <td>0H6567A0</td> <td>P-TRAP<br/>HOLDING<br/>PANEL</td> <td>1</td> <td>PZ</td> </tr> <tr> <td>GN1508A0</td> <td>O-RING<br/>GASKET COD<br/>2400</td> <td>1</td> <td>PZ</td> </tr> <tr> <td>IL1115A0</td> <td>WOODEN<br/>PALET 80X120</td> <td>0.100</td> <td>PZ</td> </tr> <tr> <td>RC1055A0</td> <td>Ø25-40 H12<br/>STAINLESS<br/>STEEL PIPE<br/>CLIP</td> <td>3</td> <td>PZ</td> </tr> <tr> <td>TB1520A0</td> <td>INT. Ø=38<br/>TH=4 DRAIN<br/>BLACK<br/>RUBBER PIPE</td> <td>2.500</td> <td>M</td> </tr> <tr> <td>VI1220A1</td> <td>4,2X12 TCB<br/>SELF-TAPPIN<br/>G SCREW</td> <td>2</td> <td>PZ</td> </tr> <tr> <td>VI1895A0</td> <td>BLIND NUT M4<br/>STAINLESS<br/>STEEL DIN 917</td> <td>4</td> <td>PZ</td> </tr> <tr> <td>VI1945A0</td> <td>ENG-VITE<br/>M4X20 TCB+<br/>INOX</td> <td>4</td> <td>PZ</td> </tr> <tr> <td>VI1950A0</td> <td>ST. STEEL<br/>4,2X13 TCB<br/>SELF-DRILLIN<br/>G SCREW</td> <td>2</td> <td>PZ</td> </tr> <tr> <td>VL1005A1</td> <td>U-TRAP TANK</td> <td>1</td> <td>PZ</td> </tr> <tr> <td>VL1006A0</td> <td>SYPHON<br/>COVER</td> <td>1</td> <td>PZ</td> </tr> <tr> <td>VM1015A1</td> <td>STAINLESS<br/>STEEL<br/>Ø30X1.5 90°<br/>BEND</td> <td>1</td> <td>PZ</td> </tr> </tbody> </table> | Code | Description | Qty | UOM | 0H6567A0 | P-TRAP<br>HOLDING<br>PANEL | 1 | PZ | GN1508A0 | O-RING<br>GASKET COD<br>2400 | 1 | PZ | IL1115A0 | WOODEN<br>PALET 80X120 | 0.100 | PZ | RC1055A0 | Ø25-40 H12<br>STAINLESS<br>STEEL PIPE<br>CLIP | 3 | PZ | TB1520A0 | INT. Ø=38<br>TH=4 DRAIN<br>BLACK<br>RUBBER PIPE | 2.500 | M | VI1220A1 | 4,2X12 TCB<br>SELF-TAPPIN<br>G SCREW | 2 | PZ | VI1895A0 | BLIND NUT M4<br>STAINLESS<br>STEEL DIN 917 | 4 | PZ | VI1945A0 | ENG-VITE<br>M4X20 TCB+<br>INOX | 4 | PZ | VI1950A0 | ST. STEEL<br>4,2X13 TCB<br>SELF-DRILLIN<br>G SCREW | 2 | PZ | VL1005A1 | U-TRAP TANK | 1 | PZ | VL1006A0 | SYPHON<br>COVER | 1 | PZ | VM1015A1 | STAINLESS<br>STEEL<br>Ø30X1.5 90°<br>BEND | 1 | PZ | XC761 | 3 OVENS LM TOP<br>XFT200 STACKING<br>KIT | <table border="1"> <thead> <tr> <th>Code</th> <th>Description</th> <th>Qty</th> <th>UOM</th> </tr> </thead> <tbody> <tr> <td>0H1237A0</td> <td>LM TOP<br/>SIPHON<br/>SUPPORT</td> <td>3</td> <td>PZ</td> </tr> <tr> <td>0H7082A0</td> <td>LM 800 XC<br/>STACKING KIT<br/>FRONT<br/>PROFILE</td> <td>2</td> <td>PZ</td> </tr> <tr> <td>0H7083A0</td> <td>LM 800 XC<br/>STACKING KIT<br/>BACK PROFIL</td> <td>4</td> <td>PZ</td> </tr> <tr> <td>ED1246A0</td> <td>HOT SURFACE<br/>LABEL</td> <td>1</td> <td>PZ</td> </tr> <tr> <td>ED1271A0</td> <td>LIQUID FALLS<br/>DANGER LABE</td> <td>1</td> <td>PZ</td> </tr> </tbody> </table> | Code | Description | Qty | UOM | 0H1237A0 | LM TOP<br>SIPHON<br>SUPPORT | 3 | PZ | 0H7082A0 | LM 800 XC<br>STACKING KIT<br>FRONT<br>PROFILE | 2 | PZ | 0H7083A0 | LM 800 XC<br>STACKING KIT<br>BACK PROFIL | 4 | PZ | ED1246A0 | HOT SURFACE<br>LABEL | 1 | PZ | ED1271A0 | LIQUID FALLS<br>DANGER LABE | 1 | PZ |
|           |  |   | Code       | Description                     | Qty   | UOM  |             |     |     |          |                            |   |    |          |                              |   |    |          |                        |       |    |          |   |   |    |          |   |       |   |          |                                      |   |    |          |  |   |    |          |                                |   |    |          |  |   |    |          |             |   |    |          |                 |   |    |          |   |   |    |       |  |   |      |             |     |     |          |                             |   |    |          |   |   |    |          |  |   |    |          |                      |   |    |          |                             |   |    |
| 0H6567A0  | P-TRAP<br>HOLDING<br>PANEL                         | 1   | PZ         |                                 |   |      |             |     |     |          |                            |   |    |          |                              |   |    |          |                        |       |    |          |   |   |    |          |   |       |   |          |                                      |   |    |          |  |   |    |          |                                |   |    |          |  |   |    |          |             |   |    |          |                 |   |    |          |   |   |    |       |  |   |      |             |     |     |          |                             |   |    |          |   |   |    |          |  |   |    |          |                      |   |    |          |                             |   |    |
| GN1508A0  | O-RING<br>GASKET COD<br>2400                       | 1   | PZ         |                                 |   |      |             |     |     |          |                            |   |    |          |                              |   |    |          |                        |       |    |          |   |   |    |          |   |       |   |          |                                      |   |    |          |  |   |    |          |                                |   |    |          |  |   |    |          |             |   |    |          |                 |   |    |          |   |   |    |       |  |   |      |             |     |     |          |                             |   |    |          |   |   |    |          |  |   |    |          |                      |   |    |          |                             |   |    |
| IL1115A0  | WOODEN<br>PALET 80X120                             | 0.100   | PZ         |                                 |   |      |             |     |     |          |                            |   |    |          |                              |   |    |          |                        |       |    |          |   |   |    |          |   |       |   |          |                                      |   |    |          |  |   |    |          |                                |   |    |          |  |   |    |          |             |   |    |          |                 |   |    |          |   |   |    |       |  |   |      |             |     |     |          |                             |   |    |          |   |   |    |          |  |   |    |          |                      |   |    |          |                             |   |    |
| RC1055A0  | Ø25-40 H12<br>STAINLESS<br>STEEL PIPE<br>CLIP      | 3   | PZ         |                                 |   |      |             |     |     |          |                            |   |    |          |                              |   |    |          |                        |       |    |          |   |   |    |          |   |       |   |          |                                      |   |    |          |  |   |    |          |                                |   |    |          |  |   |    |          |             |   |    |          |                 |   |    |          |   |   |    |       |  |   |      |             |     |     |          |                             |   |    |          |   |   |    |          |  |   |    |          |                      |   |    |          |                             |   |    |
| TB1520A0  | INT. Ø=38<br>TH=4 DRAIN<br>BLACK<br>RUBBER PIPE    | 2.500   | M          |                                 |   |      |             |     |     |          |                            |   |    |          |                              |   |    |          |                        |       |    |          |   |   |    |          |   |       |   |          |                                      |   |    |          |  |   |    |          |                                |   |    |          |  |   |    |          |             |   |    |          |                 |   |    |          |   |   |    |       |  |   |      |             |     |     |          |                             |   |    |          |   |   |    |          |  |   |    |          |                      |   |    |          |                             |   |    |
| VI1220A1  | 4,2X12 TCB<br>SELF-TAPPIN<br>G SCREW               | 2   | PZ         |                                 |   |      |             |     |     |          |                            |   |    |          |                              |   |    |          |                        |       |    |          |   |   |    |          |   |       |   |          |                                      |   |    |          |  |   |    |          |                                |   |    |          |  |   |    |          |             |   |    |          |                 |   |    |          |   |   |    |       |  |   |      |             |     |     |          |                             |   |    |          |   |   |    |          |  |   |    |          |                      |   |    |          |                             |   |    |
| VI1895A0  | BLIND NUT M4<br>STAINLESS<br>STEEL DIN 917         | 4   | PZ         |                                 |   |      |             |     |     |          |                            |   |    |          |                              |   |    |          |                        |       |    |          |   |   |    |          |   |       |   |          |                                      |   |    |          |  |   |    |          |                                |   |    |          |  |   |    |          |             |   |    |          |                 |   |    |          |   |   |    |       |  |   |      |             |     |     |          |                             |   |    |          |   |   |    |          |  |   |    |          |                      |   |    |          |                             |   |    |
| VI1945A0  | ENG-VITE<br>M4X20 TCB+<br>INOX                     | 4   | PZ         |                                 |   |      |             |     |     |          |                            |   |    |          |                              |   |    |          |                        |       |    |          |   |   |    |          |   |       |   |          |                                      |   |    |          |  |   |    |          |                                |   |    |          |  |   |    |          |             |   |    |          |                 |   |    |          |   |   |    |       |  |   |      |             |     |     |          |                             |   |    |          |   |   |    |          |  |   |    |          |                      |   |    |          |                             |   |    |
| VI1950A0  | ST. STEEL<br>4,2X13 TCB<br>SELF-DRILLIN<br>G SCREW | 2   | PZ         |                                 |   |      |             |     |     |          |                            |   |    |          |                              |   |    |          |                        |       |    |          |   |   |    |          |   |       |   |          |                                      |   |    |          |  |   |    |          |                                |   |    |          |  |   |    |          |             |   |    |          |                 |   |    |          |   |   |    |       |  |   |      |             |     |     |          |                             |   |    |          |   |   |    |          |  |   |    |          |                      |   |    |          |                             |   |    |
| VL1005A1  | U-TRAP TANK  | 1   | PZ         |                                 |   |      |             |     |     |          |                            |   |    |          |                              |   |    |          |                        |       |    |          |   |   |    |          |   |       |   |          |                                      |   |    |          |  |   |    |          |                                |   |    |          |  |   |    |          |             |   |    |          |                 |   |    |          |   |   |    |       |  |   |      |             |     |     |          |                             |   |    |          |   |   |    |          |  |   |    |          |                      |   |    |          |                             |   |    |
| VL1006A0  | SYPHON<br>COVER                                    | 1   | PZ         |                                 |   |      |             |     |     |          |                            |   |    |          |                              |   |    |          |                        |       |    |          |   |   |    |          |   |       |   |          |                                      |   |    |          |  |   |    |          |                                |   |    |          |  |   |    |          |             |   |    |          |                 |   |    |          |   |   |    |       |  |   |      |             |     |     |          |                             |   |    |          |   |   |    |          |  |   |    |          |                      |   |    |          |                             |   |    |
| VM1015A1  | STAINLESS<br>STEEL<br>Ø30X1.5 90°<br>BEND          | 1   | PZ         |                                 |   |      |             |     |     |          |                            |   |    |          |                              |   |    |          |                        |       |    |          |   |   |    |          |   |       |   |          |                                      |   |    |          |  |   |    |          |                                |   |    |          |  |   |    |          |             |   |    |          |                 |   |    |          |   |   |    |       |  |   |      |             |     |     |          |                             |   |    |          |   |   |    |          |  |   |    |          |                      |   |    |          |                             |   |    |
| Code      | Description  | Qty   | UOM        |                                 |   |      |             |     |     |          |                            |   |    |          |                              |   |    |          |                        |       |    |          |   |   |    |          |   |       |   |          |                                      |   |    |          |  |   |    |          |                                |   |    |          |  |   |    |          |             |   |    |          |                 |   |    |          |   |   |    |       |  |   |      |             |     |     |          |                             |   |    |          |   |   |    |          |  |   |    |          |                      |   |    |          |                             |   |    |
| 0H1237A0  | LM TOP<br>SIPHON<br>SUPPORT                        | 3   | PZ         |                                 |   |      |             |     |     |          |                            |   |    |          |                              |   |    |          |                        |       |    |          |   |   |    |          |   |       |   |          |                                      |   |    |          |  |   |    |          |                                |   |    |          |  |   |    |          |             |   |    |          |                 |   |    |          |   |   |    |       |  |   |      |             |     |     |          |                             |   |    |          |   |   |    |          |  |   |    |          |                      |   |    |          |                             |   |    |
| 0H7082A0  | LM 800 XC<br>STACKING KIT<br>FRONT<br>PROFILE      | 2   | PZ         |                                 |   |      |             |     |     |          |                            |   |    |          |                              |   |    |          |                        |       |    |          |   |   |    |          |   |       |   |          |                                      |   |    |          |  |   |    |          |                                |   |    |          |  |   |    |          |             |   |    |          |                 |   |    |          |   |   |    |       |  |   |      |             |     |     |          |                             |   |    |          |   |   |    |          |  |   |    |          |                      |   |    |          |                             |   |    |
| 0H7083A0  | LM 800 XC<br>STACKING KIT<br>BACK PROFIL           | 4   | PZ         |                                 |   |      |             |     |     |          |                            |   |    |          |                              |   |    |          |                        |       |    |          |   |   |    |          |   |       |   |          |                                      |   |    |          |  |   |    |          |                                |   |    |          |  |   |    |          |             |   |    |          |                 |   |    |          |   |   |    |       |  |   |      |             |     |     |          |                             |   |    |          |   |   |    |          |  |   |    |          |                      |   |    |          |                             |   |    |
| ED1246A0  | HOT SURFACE<br>LABEL                               | 1   | PZ         |                                 |   |      |             |     |     |          |                            |   |    |          |                              |   |    |          |                        |       |    |          |   |   |    |          |   |       |   |          |                                      |   |    |          |  |   |    |          |                                |   |    |          |  |   |    |          |             |   |    |          |                 |   |    |          |   |   |    |       |  |   |      |             |     |     |          |                             |   |    |          |   |   |    |          |  |   |    |          |                      |   |    |          |                             |   |    |
| ED1271A0  | LIQUID FALLS<br>DANGER LABE                        | 1   | PZ         |                                 |   |      |             |     |     |          |                            |   |    |          |                              |   |    |          |                        |       |    |          |   |   |    |          |   |       |   |          |                                      |   |    |          |  |   |    |          |                                |   |    |          |  |   |    |          |             |   |    |          |                 |   |    |          |   |   |    |       |  |   |      |             |     |     |          |                             |   |    |          |   |   |    |          |  |   |    |          |                      |   |    |          |                             |   |    |





| COMPONENT |  |   | SPARE PART |                                    |   |      |             |     |     |          |                                   |   |    |          |                                    |   |    |          |                        |   |    |          |                 |    |    |          |                                      |    |    |          |                      |   |    |          |                          |   |    |          |              |   |    |          |                                 |   |    |          |  |   |   |          |  |    |   |          |                                |   |   |          |              |   |   |          |                               |    |    |          |                                      |    |    |          |                          |    |    |          |  |    |    |          |             |   |    |          |              |   |    |
|-----------|--|---|------------|------------------------------------|---|------|-------------|-----|-----|----------|-----------------------------------|---|----|----------|------------------------------------|---|----|----------|------------------------|---|----|----------|-----------------|----|----|----------|--------------------------------------|----|----|----------|----------------------|---|----|----------|--------------------------|---|----|----------|--------------|---|----|----------|---------------------------------|---|----|----------|--|---|---|----------|--|----|---|----------|--------------------------------|---|---|----------|--------------|---|---|----------|-------------------------------|----|----|----------|--------------------------------------|----|----|----------|--------------------------|----|----|----------|--|----|----|----------|-------------|---|----|----------|--------------|---|----|
| Code      | Description                              | Image   | Code       | Description                        | Components list   |      |             |     |     |          |                                   |   |    |          |                                    |   |    |          |                        |   |    |          |                 |    |    |          |                                      |    |    |          |                      |   |    |          |                          |   |    |          |              |   |    |          |                                 |   |    |          |  |   |   |          |  |    |   |          |                                |   |   |          |              |   |   |          |                               |    |    |          |                                      |    |    |          |                          |    |    |          |  |    |    |          |             |   |    |          |              |   |    |
| VL1006A   | SYPHON COVER                             |  | XC761      | 3 OVENS LM TOP XFT200 STACKING KIT | <table border="1"> <thead> <tr> <th>Code</th> <th>Description</th> <th>Qty</th> <th>UOM</th> </tr> </thead> <tbody> <tr> <td>EL1020A1</td> <td>D8 INTERMEDIAT E T-SHAPED FITTING</td> <td>4</td> <td>PZ</td> </tr> <tr> <td>EL1180A0</td> <td>Ø8-Ø8 FEMALE NON-RETURN CONNECTION</td> <td>3</td> <td>PZ</td> </tr> <tr> <td>GN1508A0</td> <td>O-RING GASKET COD 2400</td> <td>3</td> <td>PZ</td> </tr> <tr> <td>RC1008A0</td> <td>D9 ELASTIC CLIP</td> <td>12</td> <td>PZ</td> </tr> <tr> <td>RC1055A0</td> <td>Ø25-40 H12 STAINLESS STEEL PIPE CLIP</td> <td>15</td> <td>PZ</td> </tr> <tr> <td>RC1297A1</td> <td>D10 T-SHAPED FITTING</td> <td>2</td> <td>PZ</td> </tr> <tr> <td>RC1360A0</td> <td>10 - 10 JG ELBOW FITTING</td> <td>1</td> <td>PZ</td> </tr> <tr> <td>RC1376A0</td> <td>Ø6 Y-FITTING</td> <td>2</td> <td>PZ</td> </tr> <tr> <td>TB1177A0</td> <td>FOOT PANEL 40X40 H58 OVERLAP LM</td> <td>8</td> <td>PZ</td> </tr> <tr> <td>TB1520A0</td> <td>INT. Ø=38 TH=4 DRAIN BLACK RUBBER PIPE</td> <td>5</td> <td>M</td> </tr> <tr> <td>TB1815A0</td> <td>7,93X4,75 PE TRANSP. PIPE (JG #PE08100N)</td> <td>12</td> <td>M</td> </tr> <tr> <td>TB1816A0</td> <td>CLEAR POLYPROPYLENE PIPE 6X4MM</td> <td>3</td> <td>M</td> </tr> <tr> <td>TB2243A0</td> <td>Ø10 PET PIPE</td> <td>4</td> <td>M</td> </tr> <tr> <td>VI1220A1</td> <td>4,2X12 TCB SELF-TAPPING SCREW</td> <td>30</td> <td>PZ</td> </tr> <tr> <td>VI1895A0</td> <td>BLIND NUT M4 STAINLESS STEEL DIN 917</td> <td>12</td> <td>PZ</td> </tr> <tr> <td>VI1945A0</td> <td>ENG-VITE M4X20 TCB+ INOX</td> <td>12</td> <td>PZ</td> </tr> <tr> <td>VI1950A0</td> <td>ST. STEEL 4,2X13 TCB SELF-DRILLING SCREW</td> <td>20</td> <td>PZ</td> </tr> <tr> <td>VL1005A1</td> <td>U-TRAP TANK</td> <td>3</td> <td>PZ</td> </tr> <tr> <td>VL1006A0</td> <td>SYPHON COVER</td> <td>3</td> <td>PZ</td> </tr> </tbody> </table> | Code | Description | Qty | UOM | EL1020A1 | D8 INTERMEDIAT E T-SHAPED FITTING | 4 | PZ | EL1180A0 | Ø8-Ø8 FEMALE NON-RETURN CONNECTION | 3 | PZ | GN1508A0 | O-RING GASKET COD 2400 | 3 | PZ | RC1008A0 | D9 ELASTIC CLIP | 12 | PZ | RC1055A0 | Ø25-40 H12 STAINLESS STEEL PIPE CLIP | 15 | PZ | RC1297A1 | D10 T-SHAPED FITTING | 2 | PZ | RC1360A0 | 10 - 10 JG ELBOW FITTING | 1 | PZ | RC1376A0 | Ø6 Y-FITTING | 2 | PZ | TB1177A0 | FOOT PANEL 40X40 H58 OVERLAP LM | 8 | PZ | TB1520A0 | INT. Ø=38 TH=4 DRAIN BLACK RUBBER PIPE | 5 | M | TB1815A0 | 7,93X4,75 PE TRANSP. PIPE (JG #PE08100N) | 12 | M | TB1816A0 | CLEAR POLYPROPYLENE PIPE 6X4MM | 3 | M | TB2243A0 | Ø10 PET PIPE | 4 | M | VI1220A1 | 4,2X12 TCB SELF-TAPPING SCREW | 30 | PZ | VI1895A0 | BLIND NUT M4 STAINLESS STEEL DIN 917 | 12 | PZ | VI1945A0 | ENG-VITE M4X20 TCB+ INOX | 12 | PZ | VI1950A0 | ST. STEEL 4,2X13 TCB SELF-DRILLING SCREW | 20 | PZ | VL1005A1 | U-TRAP TANK | 3 | PZ | VL1006A0 | SYPHON COVER | 3 | PZ |
| Code      | Description                              | Qty   | UOM        |                                    |   |      |             |     |     |          |                                   |   |    |          |                                    |   |    |          |                        |   |    |          |                 |    |    |          |                                      |    |    |          |                      |   |    |          |                          |   |    |          |              |   |    |          |                                 |   |    |          |  |   |   |          |  |    |   |          |                                |   |   |          |              |   |   |          |                               |    |    |          |                                      |    |    |          |                          |    |    |          |  |    |    |          |             |   |    |          |              |   |    |
| EL1020A1  | D8 INTERMEDIAT E T-SHAPED FITTING        | 4   | PZ         |                                    |   |      |             |     |     |          |                                   |   |    |          |                                    |   |    |          |                        |   |    |          |                 |    |    |          |                                      |    |    |          |                      |   |    |          |                          |   |    |          |              |   |    |          |                                 |   |    |          |  |   |   |          |  |    |   |          |                                |   |   |          |              |   |   |          |                               |    |    |          |                                      |    |    |          |                          |    |    |          |  |    |    |          |             |   |    |          |              |   |    |
| EL1180A0  | Ø8-Ø8 FEMALE NON-RETURN CONNECTION       | 3   | PZ         |                                    |   |      |             |     |     |          |                                   |   |    |          |                                    |   |    |          |                        |   |    |          |                 |    |    |          |                                      |    |    |          |                      |   |    |          |                          |   |    |          |              |   |    |          |                                 |   |    |          |  |   |   |          |  |    |   |          |                                |   |   |          |              |   |   |          |                               |    |    |          |                                      |    |    |          |                          |    |    |          |  |    |    |          |             |   |    |          |              |   |    |
| GN1508A0  | O-RING GASKET COD 2400                   | 3   | PZ         |                                    |   |      |             |     |     |          |                                   |   |    |          |                                    |   |    |          |                        |   |    |          |                 |    |    |          |                                      |    |    |          |                      |   |    |          |                          |   |    |          |              |   |    |          |                                 |   |    |          |  |   |   |          |  |    |   |          |                                |   |   |          |              |   |   |          |                               |    |    |          |                                      |    |    |          |                          |    |    |          |  |    |    |          |             |   |    |          |              |   |    |
| RC1008A0  | D9 ELASTIC CLIP                          | 12  | PZ         |                                    |   |      |             |     |     |          |                                   |   |    |          |                                    |   |    |          |                        |   |    |          |                 |    |    |          |                                      |    |    |          |                      |   |    |          |                          |   |    |          |              |   |    |          |                                 |   |    |          |  |   |   |          |  |    |   |          |                                |   |   |          |              |   |   |          |                               |    |    |          |                                      |    |    |          |                          |    |    |          |  |    |    |          |             |   |    |          |              |   |    |
| RC1055A0  | Ø25-40 H12 STAINLESS STEEL PIPE CLIP     | 15  | PZ         |                                    |   |      |             |     |     |          |                                   |   |    |          |                                    |   |    |          |                        |   |    |          |                 |    |    |          |                                      |    |    |          |                      |   |    |          |                          |   |    |          |              |   |    |          |                                 |   |    |          |  |   |   |          |  |    |   |          |                                |   |   |          |              |   |   |          |                               |    |    |          |                                      |    |    |          |                          |    |    |          |  |    |    |          |             |   |    |          |              |   |    |
| RC1297A1  | D10 T-SHAPED FITTING                     | 2   | PZ         |                                    |   |      |             |     |     |          |                                   |   |    |          |                                    |   |    |          |                        |   |    |          |                 |    |    |          |                                      |    |    |          |                      |   |    |          |                          |   |    |          |              |   |    |          |                                 |   |    |          |  |   |   |          |  |    |   |          |                                |   |   |          |              |   |   |          |                               |    |    |          |                                      |    |    |          |                          |    |    |          |  |    |    |          |             |   |    |          |              |   |    |
| RC1360A0  | 10 - 10 JG ELBOW FITTING                 | 1   | PZ         |                                    |   |      |             |     |     |          |                                   |   |    |          |                                    |   |    |          |                        |   |    |          |                 |    |    |          |                                      |    |    |          |                      |   |    |          |                          |   |    |          |              |   |    |          |                                 |   |    |          |  |   |   |          |  |    |   |          |                                |   |   |          |              |   |   |          |                               |    |    |          |                                      |    |    |          |                          |    |    |          |  |    |    |          |             |   |    |          |              |   |    |
| RC1376A0  | Ø6 Y-FITTING                             | 2   | PZ         |                                    |   |      |             |     |     |          |                                   |   |    |          |                                    |   |    |          |                        |   |    |          |                 |    |    |          |                                      |    |    |          |                      |   |    |          |                          |   |    |          |              |   |    |          |                                 |   |    |          |  |   |   |          |  |    |   |          |                                |   |   |          |              |   |   |          |                               |    |    |          |                                      |    |    |          |                          |    |    |          |  |    |    |          |             |   |    |          |              |   |    |
| TB1177A0  | FOOT PANEL 40X40 H58 OVERLAP LM          | 8   | PZ         |                                    |   |      |             |     |     |          |                                   |   |    |          |                                    |   |    |          |                        |   |    |          |                 |    |    |          |                                      |    |    |          |                      |   |    |          |                          |   |    |          |              |   |    |          |                                 |   |    |          |  |   |   |          |  |    |   |          |                                |   |   |          |              |   |   |          |                               |    |    |          |                                      |    |    |          |                          |    |    |          |  |    |    |          |             |   |    |          |              |   |    |
| TB1520A0  | INT. Ø=38 TH=4 DRAIN BLACK RUBBER PIPE   | 5   | M          |                                    |   |      |             |     |     |          |                                   |   |    |          |                                    |   |    |          |                        |   |    |          |                 |    |    |          |                                      |    |    |          |                      |   |    |          |                          |   |    |          |              |   |    |          |                                 |   |    |          |  |   |   |          |  |    |   |          |                                |   |   |          |              |   |   |          |                               |    |    |          |                                      |    |    |          |                          |    |    |          |  |    |    |          |             |   |    |          |              |   |    |
| TB1815A0  | 7,93X4,75 PE TRANSP. PIPE (JG #PE08100N) | 12  | M          |                                    |   |      |             |     |     |          |                                   |   |    |          |                                    |   |    |          |                        |   |    |          |                 |    |    |          |                                      |    |    |          |                      |   |    |          |                          |   |    |          |              |   |    |          |                                 |   |    |          |  |   |   |          |  |    |   |          |                                |   |   |          |              |   |   |          |                               |    |    |          |                                      |    |    |          |                          |    |    |          |  |    |    |          |             |   |    |          |              |   |    |
| TB1816A0  | CLEAR POLYPROPYLENE PIPE 6X4MM           | 3   | M          |                                    |   |      |             |     |     |          |                                   |   |    |          |                                    |   |    |          |                        |   |    |          |                 |    |    |          |                                      |    |    |          |                      |   |    |          |                          |   |    |          |              |   |    |          |                                 |   |    |          |  |   |   |          |  |    |   |          |                                |   |   |          |              |   |   |          |                               |    |    |          |                                      |    |    |          |                          |    |    |          |  |    |    |          |             |   |    |          |              |   |    |
| TB2243A0  | Ø10 PET PIPE                             | 4   | M          |                                    |   |      |             |     |     |          |                                   |   |    |          |                                    |   |    |          |                        |   |    |          |                 |    |    |          |                                      |    |    |          |                      |   |    |          |                          |   |    |          |              |   |    |          |                                 |   |    |          |  |   |   |          |  |    |   |          |                                |   |   |          |              |   |   |          |                               |    |    |          |                                      |    |    |          |                          |    |    |          |  |    |    |          |             |   |    |          |              |   |    |
| VI1220A1  | 4,2X12 TCB SELF-TAPPING SCREW            | 30  | PZ         |                                    |   |      |             |     |     |          |                                   |   |    |          |                                    |   |    |          |                        |   |    |          |                 |    |    |          |                                      |    |    |          |                      |   |    |          |                          |   |    |          |              |   |    |          |                                 |   |    |          |  |   |   |          |  |    |   |          |                                |   |   |          |              |   |   |          |                               |    |    |          |                                      |    |    |          |                          |    |    |          |  |    |    |          |             |   |    |          |              |   |    |
| VI1895A0  | BLIND NUT M4 STAINLESS STEEL DIN 917     | 12  | PZ         |                                    |   |      |             |     |     |          |                                   |   |    |          |                                    |   |    |          |                        |   |    |          |                 |    |    |          |                                      |    |    |          |                      |   |    |          |                          |   |    |          |              |   |    |          |                                 |   |    |          |  |   |   |          |  |    |   |          |                                |   |   |          |              |   |   |          |                               |    |    |          |                                      |    |    |          |                          |    |    |          |  |    |    |          |             |   |    |          |              |   |    |
| VI1945A0  | ENG-VITE M4X20 TCB+ INOX                 | 12  | PZ         |                                    |   |      |             |     |     |          |                                   |   |    |          |                                    |   |    |          |                        |   |    |          |                 |    |    |          |                                      |    |    |          |                      |   |    |          |                          |   |    |          |              |   |    |          |                                 |   |    |          |  |   |   |          |  |    |   |          |                                |   |   |          |              |   |   |          |                               |    |    |          |                                      |    |    |          |                          |    |    |          |  |    |    |          |             |   |    |          |              |   |    |
| VI1950A0  | ST. STEEL 4,2X13 TCB SELF-DRILLING SCREW | 20  | PZ         |                                    |   |      |             |     |     |          |                                   |   |    |          |                                    |   |    |          |                        |   |    |          |                 |    |    |          |                                      |    |    |          |                      |   |    |          |                          |   |    |          |              |   |    |          |                                 |   |    |          |  |   |   |          |  |    |   |          |                                |   |   |          |              |   |   |          |                               |    |    |          |                                      |    |    |          |                          |    |    |          |  |    |    |          |             |   |    |          |              |   |    |
| VL1005A1  | U-TRAP TANK                              | 3   | PZ         |                                    |   |      |             |     |     |          |                                   |   |    |          |                                    |   |    |          |                        |   |    |          |                 |    |    |          |                                      |    |    |          |                      |   |    |          |                          |   |    |          |              |   |    |          |                                 |   |    |          |  |   |   |          |  |    |   |          |                                |   |   |          |              |   |   |          |                               |    |    |          |                                      |    |    |          |                          |    |    |          |  |    |    |          |             |   |    |          |              |   |    |
| VL1006A0  | SYPHON COVER                             | 3   | PZ         |                                    |   |      |             |     |     |          |                                   |   |    |          |                                    |   |    |          |                        |   |    |          |                 |    |    |          |                                      |    |    |          |                      |   |    |          |                          |   |    |          |              |   |    |          |                                 |   |    |          |  |   |   |          |  |    |   |          |                                |   |   |          |              |   |   |          |                               |    |    |          |                                      |    |    |          |                          |    |    |          |  |    |    |          |             |   |    |          |              |   |    |

| COMPONENT |   |  | SPARE PART |  |   |      |             |                        |     |          |   |                            |    |          |   |                      |    |          |                             |                             |    |          |                       |  |    |    |          |                              |   |    |          |                               |   |    |          |                    |   |    |          |   |    |    |          |                         |   |    |          |                         |   |    |          |              |   |    |          |   |   |   |          |   |   |    |          |              |       |   |          |                                      |   |    |          |  |   |    |
|-----------|---|--|------------|--|---|------|-------------|------------------------|-----|----------|---|----------------------------|----|----------|---|----------------------|----|----------|-----------------------------|-----------------------------|----|----------|-----------------------|--|----|----|----------|------------------------------|---|----|----------|-------------------------------|---|----|----------|--------------------|---|----|----------|---|----|----|----------|-------------------------|---|----|----------|-------------------------|---|----|----------|--------------|---|----|----------|---|---|---|----------|---|---|----|----------|--------------|-------|---|----------|--------------------------------------|---|----|----------|--|---|----|
| Code      | Description                                     | Image  | Code       | Description                              | Components list   |      |             |                        |     |          |   |                            |    |          |   |                      |    |          |                             |                             |    |          |                       |  |    |    |          |                              |   |    |          |                               |   |    |          |                    |   |    |          |   |    |    |          |                         |   |    |          |                         |   |    |          |              |   |    |          |   |   |   |          |   |   |    |          |              |       |   |          |                                      |   |    |          |  |   |    |
| VL1006A   | SYPHON COVER                                    |   | XC761      | 3 OVENS LM TOP<br>XFT200 STACKING<br>KIT | <table border="1"> <thead> <tr> <th>Code</th> <th>Description</th> <th>Qty</th> <th>UOM</th> </tr> </thead> <tbody> <tr> <td>VL1046A1</td> <td>D6 PIPE<br/>HOLDER - D6<br/>J.G. TERMINAL</td> <td>12</td> <td>PZ</td> </tr> <tr> <td>VM1015A1</td> <td>STAINLESS<br/>STEEL<br/>Ø30X1.5 90°<br/>BEND</td> <td>1</td> <td>PZ</td> </tr> <tr> <td>VM1794A0</td> <td>250X4.8 PA66<br/>BLACK CLAMP</td> <td>3</td> <td>PZ</td> </tr> <tr> <td>VM2035A0</td> <td>DRAIN PIPE<br/>SUPPORT</td> <td>3</td> <td>PZ</td> </tr> </tbody> </table> | Code | Description | Qty                    | UOM | VL1046A1 | D6 PIPE<br>HOLDER - D6<br>J.G. TERMINAL | 12                         | PZ | VM1015A1 | STAINLESS<br>STEEL<br>Ø30X1.5 90°<br>BEND | 1                    | PZ | VM1794A0 | 250X4.8 PA66<br>BLACK CLAMP | 3                           | PZ | VM2035A0 | DRAIN PIPE<br>SUPPORT | 3  | PZ |    |          |                              |   |    |          |                               |   |    |          |                    |   |    |          |   |    |    |          |                         |   |    |          |                         |   |    |          |              |   |    |          |   |   |   |          |   |   |    |          |              |       |   |          |                                      |   |    |          |  |   |    |
|           |   |  | Code       | Description                              | Qty   | UOM  |             |                        |     |          |   |                            |    |          |   |                      |    |          |                             |                             |    |          |                       |  |    |    |          |                              |   |    |          |                               |   |    |          |                    |   |    |          |   |    |    |          |                         |   |    |          |                         |   |    |          |              |   |    |          |   |   |   |          |   |   |    |          |              |       |   |          |                                      |   |    |          |  |   |    |
| VL1046A1  | D6 PIPE<br>HOLDER - D6<br>J.G. TERMINAL         | 12   | PZ         |  |   |      |             |                        |     |          |   |                            |    |          |   |                      |    |          |                             |                             |    |          |                       |  |    |    |          |                              |   |    |          |                               |   |    |          |                    |   |    |          |   |    |    |          |                         |   |    |          |                         |   |    |          |              |   |    |          |   |   |   |          |   |   |    |          |              |       |   |          |                                      |   |    |          |  |   |    |
| VM1015A1  | STAINLESS<br>STEEL<br>Ø30X1.5 90°<br>BEND       | 1  | PZ         |  |   |      |             |                        |     |          |   |                            |    |          |   |                      |    |          |                             |                             |    |          |                       |  |    |    |          |                              |   |    |          |                               |   |    |          |                    |   |    |          |   |    |    |          |                         |   |    |          |                         |   |    |          |              |   |    |          |   |   |   |          |   |   |    |          |              |       |   |          |                                      |   |    |          |  |   |    |
| VM1794A0  | 250X4.8 PA66<br>BLACK CLAMP                     | 3  | PZ         |  |   |      |             |                        |     |          |   |                            |    |          |   |                      |    |          |                             |                             |    |          |                       |  |    |    |          |                              |   |    |          |                               |   |    |          |                    |   |    |          |   |    |    |          |                         |   |    |          |                         |   |    |          |              |   |    |          |   |   |   |          |   |   |    |          |              |       |   |          |                                      |   |    |          |  |   |    |
| VM2035A0  | DRAIN PIPE<br>SUPPORT                           | 3  | PZ         |  |   |      |             |                        |     |          |   |                            |    |          |   |                      |    |          |                             |                             |    |          |                       |  |    |    |          |                              |   |    |          |                               |   |    |          |                    |   |    |          |   |    |    |          |                         |   |    |          |                         |   |    |          |              |   |    |          |   |   |   |          |   |   |    |          |              |       |   |          |                                      |   |    |          |  |   |    |
| XC757     | S. E CHEFTOP<br>GN1/1 STACKING KI               | <table border="1"> <thead> <tr> <th>Code</th> <th>Description</th> <th>Qty</th> <th>UOM</th> </tr> </thead> <tbody> <tr> <td>0H6463A0</td> <td>XC757 FRONT<br/>PROFILE</td> <td>1</td> <td>PZ</td> </tr> <tr> <td>CE1305A0</td> <td>L=2MT RJ45 -<br/>RJ45 CABLE</td> <td>1</td> <td>PZ</td> </tr> <tr> <td>ED1246A0</td> <td>HOT SURFACE<br/>LABEL</td> <td>2</td> <td>PZ</td> </tr> <tr> <td>ED1271A0</td> <td>LIQUID FALLS<br/>DANGER LABE</td> <td>1</td> <td>PZ</td> </tr> <tr> <td>EL1020A1</td> <td>D8<br/>INTERMEDIAT<br/>E T-SHAPED<br/>FITTING</td> <td>2</td> <td>PZ</td> </tr> <tr> <td>GN1508A0</td> <td>O-RING<br/>GASKET COD<br/>2400</td> <td>2</td> <td>PZ</td> </tr> <tr> <td>PD1069A0</td> <td>FOOT<br/>OVERLAP S5<br/>CT-BT-E</td> <td>1</td> <td>PZ</td> </tr> <tr> <td>RC1008A0</td> <td>D9 ELASTIC<br/>CLIP</td> <td>3</td> <td>PZ</td> </tr> <tr> <td>RC1055A0</td> <td>Ø25-40 H12<br/>STAINLESS<br/>STEEL PIPE<br/>CLIP</td> <td>14</td> <td>PZ</td> </tr> <tr> <td>RC1130A0</td> <td>130X2,6 CLAM<br/>FITTING</td> <td>3</td> <td>PZ</td> </tr> <tr> <td>RC1297A1</td> <td>D10 T-SHAPED<br/>FITTING</td> <td>1</td> <td>PZ</td> </tr> <tr> <td>RC1376A0</td> <td>Ø6 Y-FITTING</td> <td>1</td> <td>PZ</td> </tr> <tr> <td>TB1520A0</td> <td>INT. Ø=38<br/>TH=4 DRAIN<br/>BLACK<br/>RUBBER PIPE</td> <td>5</td> <td>M</td> </tr> <tr> <td>TB1765A1</td> <td>STACKING KIT<br/>CHIMNEY<br/>CONNECTING<br/>PIPE</td> <td>2</td> <td>PZ</td> </tr> <tr> <td>TB2243A0</td> <td>Ø10 PET PIPE</td> <td>1.500</td> <td>M</td> </tr> <tr> <td>VI1220A1</td> <td>4,2X12 TCB<br/>SELF-TAPPIN<br/>G SCREW</td> <td>4</td> <td>PZ</td> </tr> <tr> <td>VI1895A0</td> <td>BLIND NUT M4<br/>STAINLESS<br/>STEEL DIN 917</td> <td>8</td> <td>PZ</td> </tr> </tbody> </table> | Code       | Description                              | Qty   | UOM  | 0H6463A0    | XC757 FRONT<br>PROFILE | 1   | PZ       | CE1305A0                                | L=2MT RJ45 -<br>RJ45 CABLE | 1  | PZ       | ED1246A0                                  | HOT SURFACE<br>LABEL | 2  | PZ       | ED1271A0                    | LIQUID FALLS<br>DANGER LABE | 1  | PZ       | EL1020A1              | D8<br>INTERMEDIAT<br>E T-SHAPED<br>FITTING | 2  | PZ | GN1508A0 | O-RING<br>GASKET COD<br>2400 | 2 | PZ | PD1069A0 | FOOT<br>OVERLAP S5<br>CT-BT-E | 1 | PZ | RC1008A0 | D9 ELASTIC<br>CLIP | 3 | PZ | RC1055A0 | Ø25-40 H12<br>STAINLESS<br>STEEL PIPE<br>CLIP | 14 | PZ | RC1130A0 | 130X2,6 CLAM<br>FITTING | 3 | PZ | RC1297A1 | D10 T-SHAPED<br>FITTING | 1 | PZ | RC1376A0 | Ø6 Y-FITTING | 1 | PZ | TB1520A0 | INT. Ø=38<br>TH=4 DRAIN<br>BLACK<br>RUBBER PIPE | 5 | M | TB1765A1 | STACKING KIT<br>CHIMNEY<br>CONNECTING<br>PIPE | 2 | PZ | TB2243A0 | Ø10 PET PIPE | 1.500 | M | VI1220A1 | 4,2X12 TCB<br>SELF-TAPPIN<br>G SCREW | 4 | PZ | VI1895A0 | BLIND NUT M4<br>STAINLESS<br>STEEL DIN 917 | 8 | PZ |
| Code      | Description                                     | Qty  | UOM        |  |   |      |             |                        |     |          |   |                            |    |          |   |                      |    |          |                             |                             |    |          |                       |  |    |    |          |                              |   |    |          |                               |   |    |          |                    |   |    |          |   |    |    |          |                         |   |    |          |                         |   |    |          |              |   |    |          |   |   |   |          |   |   |    |          |              |       |   |          |                                      |   |    |          |  |   |    |
| 0H6463A0  | XC757 FRONT<br>PROFILE                          | 1  | PZ         |  |   |      |             |                        |     |          |   |                            |    |          |   |                      |    |          |                             |                             |    |          |                       |  |    |    |          |                              |   |    |          |                               |   |    |          |                    |   |    |          |   |    |    |          |                         |   |    |          |                         |   |    |          |              |   |    |          |   |   |   |          |   |   |    |          |              |       |   |          |                                      |   |    |          |  |   |    |
| CE1305A0  | L=2MT RJ45 -<br>RJ45 CABLE                      | 1  | PZ         |  |   |      |             |                        |     |          |   |                            |    |          |   |                      |    |          |                             |                             |    |          |                       |  |    |    |          |                              |   |    |          |                               |   |    |          |                    |   |    |          |   |    |    |          |                         |   |    |          |                         |   |    |          |              |   |    |          |   |   |   |          |   |   |    |          |              |       |   |          |                                      |   |    |          |  |   |    |
| ED1246A0  | HOT SURFACE<br>LABEL                            | 2  | PZ         |  |   |      |             |                        |     |          |   |                            |    |          |   |                      |    |          |                             |                             |    |          |                       |  |    |    |          |                              |   |    |          |                               |   |    |          |                    |   |    |          |   |    |    |          |                         |   |    |          |                         |   |    |          |              |   |    |          |   |   |   |          |   |   |    |          |              |       |   |          |                                      |   |    |          |  |   |    |
| ED1271A0  | LIQUID FALLS<br>DANGER LABE                     | 1  | PZ         |  |   |      |             |                        |     |          |   |                            |    |          |   |                      |    |          |                             |                             |    |          |                       |  |    |    |          |                              |   |    |          |                               |   |    |          |                    |   |    |          |   |    |    |          |                         |   |    |          |                         |   |    |          |              |   |    |          |   |   |   |          |   |   |    |          |              |       |   |          |                                      |   |    |          |  |   |    |
| EL1020A1  | D8<br>INTERMEDIAT<br>E T-SHAPED<br>FITTING      | 2  | PZ         |  |   |      |             |                        |     |          |   |                            |    |          |   |                      |    |          |                             |                             |    |          |                       |  |    |    |          |                              |   |    |          |                               |   |    |          |                    |   |    |          |   |    |    |          |                         |   |    |          |                         |   |    |          |              |   |    |          |   |   |   |          |   |   |    |          |              |       |   |          |                                      |   |    |          |  |   |    |
| GN1508A0  | O-RING<br>GASKET COD<br>2400                    | 2  | PZ         |  |   |      |             |                        |     |          |   |                            |    |          |   |                      |    |          |                             |                             |    |          |                       |  |    |    |          |                              |   |    |          |                               |   |    |          |                    |   |    |          |   |    |    |          |                         |   |    |          |                         |   |    |          |              |   |    |          |   |   |   |          |   |   |    |          |              |       |   |          |                                      |   |    |          |  |   |    |
| PD1069A0  | FOOT<br>OVERLAP S5<br>CT-BT-E                   | 1  | PZ         |  |   |      |             |                        |     |          |   |                            |    |          |   |                      |    |          |                             |                             |    |          |                       |  |    |    |          |                              |   |    |          |                               |   |    |          |                    |   |    |          |   |    |    |          |                         |   |    |          |                         |   |    |          |              |   |    |          |   |   |   |          |   |   |    |          |              |       |   |          |                                      |   |    |          |  |   |    |
| RC1008A0  | D9 ELASTIC<br>CLIP                              | 3  | PZ         |  |   |      |             |                        |     |          |   |                            |    |          |   |                      |    |          |                             |                             |    |          |                       |  |    |    |          |                              |   |    |          |                               |   |    |          |                    |   |    |          |   |    |    |          |                         |   |    |          |                         |   |    |          |              |   |    |          |   |   |   |          |   |   |    |          |              |       |   |          |                                      |   |    |          |  |   |    |
| RC1055A0  | Ø25-40 H12<br>STAINLESS<br>STEEL PIPE<br>CLIP   | 14   | PZ         |  |   |      |             |                        |     |          |   |                            |    |          |   |                      |    |          |                             |                             |    |          |                       |  |    |    |          |                              |   |    |          |                               |   |    |          |                    |   |    |          |   |    |    |          |                         |   |    |          |                         |   |    |          |              |   |    |          |   |   |   |          |   |   |    |          |              |       |   |          |                                      |   |    |          |  |   |    |
| RC1130A0  | 130X2,6 CLAM<br>FITTING                         | 3  | PZ         |  |   |      |             |                        |     |          |   |                            |    |          |   |                      |    |          |                             |                             |    |          |                       |  |    |    |          |                              |   |    |          |                               |   |    |          |                    |   |    |          |   |    |    |          |                         |   |    |          |                         |   |    |          |              |   |    |          |   |   |   |          |   |   |    |          |              |       |   |          |                                      |   |    |          |  |   |    |
| RC1297A1  | D10 T-SHAPED<br>FITTING                         | 1  | PZ         |  |   |      |             |                        |     |          |   |                            |    |          |   |                      |    |          |                             |                             |    |          |                       |  |    |    |          |                              |   |    |          |                               |   |    |          |                    |   |    |          |   |    |    |          |                         |   |    |          |                         |   |    |          |              |   |    |          |   |   |   |          |   |   |    |          |              |       |   |          |                                      |   |    |          |  |   |    |
| RC1376A0  | Ø6 Y-FITTING                                    | 1  | PZ         |  |   |      |             |                        |     |          |   |                            |    |          |   |                      |    |          |                             |                             |    |          |                       |  |    |    |          |                              |   |    |          |                               |   |    |          |                    |   |    |          |   |    |    |          |                         |   |    |          |                         |   |    |          |              |   |    |          |   |   |   |          |   |   |    |          |              |       |   |          |                                      |   |    |          |  |   |    |
| TB1520A0  | INT. Ø=38<br>TH=4 DRAIN<br>BLACK<br>RUBBER PIPE | 5  | M          |  |   |      |             |                        |     |          |   |                            |    |          |   |                      |    |          |                             |                             |    |          |                       |  |    |    |          |                              |   |    |          |                               |   |    |          |                    |   |    |          |   |    |    |          |                         |   |    |          |                         |   |    |          |              |   |    |          |   |   |   |          |   |   |    |          |              |       |   |          |                                      |   |    |          |  |   |    |
| TB1765A1  | STACKING KIT<br>CHIMNEY<br>CONNECTING<br>PIPE   | 2  | PZ         |  |   |      |             |                        |     |          |   |                            |    |          |   |                      |    |          |                             |                             |    |          |                       |  |    |    |          |                              |   |    |          |                               |   |    |          |                    |   |    |          |   |    |    |          |                         |   |    |          |                         |   |    |          |              |   |    |          |   |   |   |          |   |   |    |          |              |       |   |          |                                      |   |    |          |  |   |    |
| TB2243A0  | Ø10 PET PIPE                                    | 1.500  | M          |  |   |      |             |                        |     |          |   |                            |    |          |   |                      |    |          |                             |                             |    |          |                       |  |    |    |          |                              |   |    |          |                               |   |    |          |                    |   |    |          |   |    |    |          |                         |   |    |          |                         |   |    |          |              |   |    |          |   |   |   |          |   |   |    |          |              |       |   |          |                                      |   |    |          |  |   |    |
| VI1220A1  | 4,2X12 TCB<br>SELF-TAPPIN<br>G SCREW            | 4  | PZ         |  |   |      |             |                        |     |          |   |                            |    |          |   |                      |    |          |                             |                             |    |          |                       |  |    |    |          |                              |   |    |          |                               |   |    |          |                    |   |    |          |   |    |    |          |                         |   |    |          |                         |   |    |          |              |   |    |          |   |   |   |          |   |   |    |          |              |       |   |          |                                      |   |    |          |  |   |    |
| VI1895A0  | BLIND NUT M4<br>STAINLESS<br>STEEL DIN 917      | 8  | PZ         |  |   |      |             |                        |     |          |   |                            |    |          |   |                      |    |          |                             |                             |    |          |                       |  |    |    |          |                              |   |    |          |                               |   |    |          |                    |   |    |          |   |    |    |          |                         |   |    |          |                         |   |    |          |              |   |    |          |   |   |   |          |   |   |    |          |              |       |   |          |                                      |   |    |          |  |   |    |

| COMPONENT |  |   | SPARE PART |                                   |  |      |             |     |     |          |                                |   |    |          |  |    |    |          |                      |   |    |          |                             |   |    |          |  |   |    |          |   |   |    |          |   |   |    |          |                             |   |    |          |   |    |    |          |                       |   |    |          |                         |   |    |
|-----------|--|---|------------|-----------------------------------|--|------|-------------|-----|-----|----------|--------------------------------|---|----|----------|--|----|----|----------|----------------------|---|----|----------|-----------------------------|---|----|----------|--|---|----|----------|---|---|----|----------|---|---|----|----------|-----------------------------|---|----|----------|---|----|----|----------|-----------------------|---|----|----------|-------------------------|---|----|
| Code      | Description  | Image   | Code       | Description                       | Components list  |      |             |     |     |          |                                |   |    |          |  |    |    |          |                      |   |    |          |                             |   |    |          |  |   |    |          |   |   |    |          |   |   |    |          |                             |   |    |          |   |    |    |          |                       |   |    |          |                         |   |    |
| VL1006A   | SYPHON COVER                                       |  | XC757      | S. E CHEFTOP<br>GN1/1 STACKING KI | <table border="1"> <thead> <tr> <th>Code</th> <th>Description</th> <th>Qty</th> <th>UOM</th> </tr> </thead> <tbody> <tr> <td>VI1945A0</td> <td>ENG-VITE<br/>M4X20 TCB+<br/>INOX</td> <td>8</td> <td>PZ</td> </tr> <tr> <td>VI1950A0</td> <td>ST. STEEL<br/>4,2X13 TCB<br/>SELF-DRILLIN<br/>G SCREW</td> <td>26</td> <td>PZ</td> </tr> <tr> <td>VL1005A1</td> <td>U-TRAP TANK</td> <td>2</td> <td>PZ</td> </tr> <tr> <td>VL1006A0</td> <td>SYPHON<br/>COVER</td> <td>2</td> <td>PZ</td> </tr> <tr> <td>VL1043A0</td> <td>D4 PIPE<br/>HOLDER - D6<br/>J.G. TERMINAL</td> <td>3</td> <td>PZ</td> </tr> <tr> <td>VL1046A1</td> <td>D6 PIPE<br/>HOLDER - D6<br/>J.G. TERMINAL</td> <td>3</td> <td>PZ</td> </tr> <tr> <td>VM1015A1</td> <td>STAINLESS<br/>STEEL<br/>Ø30X1,5 90°<br/>BEND</td> <td>1</td> <td>PZ</td> </tr> <tr> <td>VM1794A0</td> <td>250X4,8 PA66<br/>BLACK CLAMP</td> <td>3</td> <td>PZ</td> </tr> <tr> <td>VM1987A0</td> <td>BRACKET FOR<br/>OVENS<br/>STACKING</td> <td>1</td> <td>PZ</td> </tr> <tr> <td>VM2035A0</td> <td>DRAIN PIPE<br/>SUPPORT</td> <td>2</td> <td>PZ</td> </tr> </tbody> </table>   | Code | Description | Qty | UOM | VI1945A0 | ENG-VITE<br>M4X20 TCB+<br>INOX | 8 | PZ | VI1950A0 | ST. STEEL<br>4,2X13 TCB<br>SELF-DRILLIN<br>G SCREW | 26 | PZ | VL1005A1 | U-TRAP TANK          | 2 | PZ | VL1006A0 | SYPHON<br>COVER             | 2 | PZ | VL1043A0 | D4 PIPE<br>HOLDER - D6<br>J.G. TERMINAL    | 3 | PZ | VL1046A1 | D6 PIPE<br>HOLDER - D6<br>J.G. TERMINAL | 3 | PZ | VM1015A1 | STAINLESS<br>STEEL<br>Ø30X1,5 90°<br>BEND | 1 | PZ | VM1794A0 | 250X4,8 PA66<br>BLACK CLAMP | 3 | PZ | VM1987A0 | BRACKET FOR<br>OVENS<br>STACKING              | 1  | PZ | VM2035A0 | DRAIN PIPE<br>SUPPORT | 2 | PZ |          |                         |   |    |
| Code      | Description  | Qty   | UOM        |                                   |  |      |             |     |     |          |                                |   |    |          |  |    |    |          |                      |   |    |          |                             |   |    |          |  |   |    |          |   |   |    |          |   |   |    |          |                             |   |    |          |   |    |    |          |                       |   |    |          |                         |   |    |
| VI1945A0  | ENG-VITE<br>M4X20 TCB+<br>INOX                     | 8   | PZ         |                                   |  |      |             |     |     |          |                                |   |    |          |  |    |    |          |                      |   |    |          |                             |   |    |          |  |   |    |          |   |   |    |          |   |   |    |          |                             |   |    |          |   |    |    |          |                       |   |    |          |                         |   |    |
| VI1950A0  | ST. STEEL<br>4,2X13 TCB<br>SELF-DRILLIN<br>G SCREW | 26  | PZ         |                                   |  |      |             |     |     |          |                                |   |    |          |  |    |    |          |                      |   |    |          |                             |   |    |          |  |   |    |          |   |   |    |          |   |   |    |          |                             |   |    |          |   |    |    |          |                       |   |    |          |                         |   |    |
| VL1005A1  | U-TRAP TANK  | 2   | PZ         |                                   |  |      |             |     |     |          |                                |   |    |          |  |    |    |          |                      |   |    |          |                             |   |    |          |  |   |    |          |   |   |    |          |   |   |    |          |                             |   |    |          |   |    |    |          |                       |   |    |          |                         |   |    |
| VL1006A0  | SYPHON<br>COVER                                    | 2   | PZ         |                                   |  |      |             |     |     |          |                                |   |    |          |  |    |    |          |                      |   |    |          |                             |   |    |          |  |   |    |          |   |   |    |          |   |   |    |          |                             |   |    |          |   |    |    |          |                       |   |    |          |                         |   |    |
| VL1043A0  | D4 PIPE<br>HOLDER - D6<br>J.G. TERMINAL            | 3   | PZ         |                                   |  |      |             |     |     |          |                                |   |    |          |  |    |    |          |                      |   |    |          |                             |   |    |          |  |   |    |          |   |   |    |          |   |   |    |          |                             |   |    |          |   |    |    |          |                       |   |    |          |                         |   |    |
| VL1046A1  | D6 PIPE<br>HOLDER - D6<br>J.G. TERMINAL            | 3   | PZ         |                                   |  |      |             |     |     |          |                                |   |    |          |  |    |    |          |                      |   |    |          |                             |   |    |          |  |   |    |          |   |   |    |          |   |   |    |          |                             |   |    |          |   |    |    |          |                       |   |    |          |                         |   |    |
| VM1015A1  | STAINLESS<br>STEEL<br>Ø30X1,5 90°<br>BEND          | 1   | PZ         |                                   |  |      |             |     |     |          |                                |   |    |          |  |    |    |          |                      |   |    |          |                             |   |    |          |  |   |    |          |   |   |    |          |   |   |    |          |                             |   |    |          |   |    |    |          |                       |   |    |          |                         |   |    |
| VM1794A0  | 250X4,8 PA66<br>BLACK CLAMP                        | 3   | PZ         |                                   |  |      |             |     |     |          |                                |   |    |          |  |    |    |          |                      |   |    |          |                             |   |    |          |  |   |    |          |   |   |    |          |   |   |    |          |                             |   |    |          |   |    |    |          |                       |   |    |          |                         |   |    |
| VM1987A0  | BRACKET FOR<br>OVENS<br>STACKING                   | 1   | PZ         |                                   |  |      |             |     |     |          |                                |   |    |          |  |    |    |          |                      |   |    |          |                             |   |    |          |  |   |    |          |   |   |    |          |   |   |    |          |                             |   |    |          |   |    |    |          |                       |   |    |          |                         |   |    |
| VM2035A0  | DRAIN PIPE<br>SUPPORT                              | 2   | PZ         |                                   |  |      |             |     |     |          |                                |   |    |          |  |    |    |          |                      |   |    |          |                             |   |    |          |  |   |    |          |   |   |    |          |   |   |    |          |                             |   |    |          |   |    |    |          |                       |   |    |          |                         |   |    |
|           |  |   | XC756      | E SERIES GN 2/3<br>STACKING KIT   | <table border="1"> <thead> <tr> <th>Code</th> <th>Description</th> <th>Qty</th> <th>UOM</th> </tr> </thead> <tbody> <tr> <td>0H6462A0</td> <td>XC756 FRONT<br/>PROFILE</td> <td>1</td> <td>PZ</td> </tr> <tr> <td>CE1305A0</td> <td>L=2MT RJ45 -<br/>RJ45 CABLE</td> <td>1</td> <td>PZ</td> </tr> <tr> <td>ED1246A0</td> <td>HOT SURFACE<br/>LABEL</td> <td>1</td> <td>PZ</td> </tr> <tr> <td>ED1271A0</td> <td>LIQUID FALLS<br/>DANGER LABE</td> <td>1</td> <td>PZ</td> </tr> <tr> <td>EL1020A1</td> <td>D8<br/>INTERMEDIAT<br/>E T-SHAPED<br/>FITTING</td> <td>2</td> <td>PZ</td> </tr> <tr> <td>GN1508A0</td> <td>O-RING<br/>GASKET COD<br/>2400</td> <td>2</td> <td>PZ</td> </tr> <tr> <td>PD1069A0</td> <td>FOOT<br/>OVERLAP S5<br/>CT-BT-E</td> <td>1</td> <td>PZ</td> </tr> <tr> <td>RC1008A0</td> <td>D9 ELASTIC<br/>CLIP</td> <td>3</td> <td>PZ</td> </tr> <tr> <td>RC1055A0</td> <td>Ø25-40 H12<br/>STAINLESS<br/>STEEL PIPE<br/>CLIP</td> <td>14</td> <td>PZ</td> </tr> <tr> <td>RC1130A0</td> <td>130X2,6 CLAM</td> <td>3</td> <td>PZ</td> </tr> <tr> <td>RC1297A1</td> <td>D10 T-SHAPED<br/>FITTING</td> <td>1</td> <td>PZ</td> </tr> </tbody> </table> | Code | Description | Qty | UOM | 0H6462A0 | XC756 FRONT<br>PROFILE         | 1 | PZ | CE1305A0 | L=2MT RJ45 -<br>RJ45 CABLE                         | 1  | PZ | ED1246A0 | HOT SURFACE<br>LABEL | 1 | PZ | ED1271A0 | LIQUID FALLS<br>DANGER LABE | 1 | PZ | EL1020A1 | D8<br>INTERMEDIAT<br>E T-SHAPED<br>FITTING | 2 | PZ | GN1508A0 | O-RING<br>GASKET COD<br>2400            | 2 | PZ | PD1069A0 | FOOT<br>OVERLAP S5<br>CT-BT-E             | 1 | PZ | RC1008A0 | D9 ELASTIC<br>CLIP          | 3 | PZ | RC1055A0 | Ø25-40 H12<br>STAINLESS<br>STEEL PIPE<br>CLIP | 14 | PZ | RC1130A0 | 130X2,6 CLAM          | 3 | PZ | RC1297A1 | D10 T-SHAPED<br>FITTING | 1 | PZ |
| Code      | Description  | Qty   | UOM        |                                   |  |      |             |     |     |          |                                |   |    |          |  |    |    |          |                      |   |    |          |                             |   |    |          |  |   |    |          |   |   |    |          |   |   |    |          |                             |   |    |          |   |    |    |          |                       |   |    |          |                         |   |    |
| 0H6462A0  | XC756 FRONT<br>PROFILE                             | 1   | PZ         |                                   |  |      |             |     |     |          |                                |   |    |          |  |    |    |          |                      |   |    |          |                             |   |    |          |  |   |    |          |   |   |    |          |   |   |    |          |                             |   |    |          |   |    |    |          |                       |   |    |          |                         |   |    |
| CE1305A0  | L=2MT RJ45 -<br>RJ45 CABLE                         | 1   | PZ         |                                   |  |      |             |     |     |          |                                |   |    |          |  |    |    |          |                      |   |    |          |                             |   |    |          |  |   |    |          |   |   |    |          |   |   |    |          |                             |   |    |          |   |    |    |          |                       |   |    |          |                         |   |    |
| ED1246A0  | HOT SURFACE<br>LABEL                               | 1   | PZ         |                                   |  |      |             |     |     |          |                                |   |    |          |  |    |    |          |                      |   |    |          |                             |   |    |          |  |   |    |          |   |   |    |          |   |   |    |          |                             |   |    |          |   |    |    |          |                       |   |    |          |                         |   |    |
| ED1271A0  | LIQUID FALLS<br>DANGER LABE                        | 1   | PZ         |                                   |  |      |             |     |     |          |                                |   |    |          |  |    |    |          |                      |   |    |          |                             |   |    |          |  |   |    |          |   |   |    |          |   |   |    |          |                             |   |    |          |   |    |    |          |                       |   |    |          |                         |   |    |
| EL1020A1  | D8<br>INTERMEDIAT<br>E T-SHAPED<br>FITTING         | 2   | PZ         |                                   |  |      |             |     |     |          |                                |   |    |          |  |    |    |          |                      |   |    |          |                             |   |    |          |  |   |    |          |   |   |    |          |   |   |    |          |                             |   |    |          |   |    |    |          |                       |   |    |          |                         |   |    |
| GN1508A0  | O-RING<br>GASKET COD<br>2400                       | 2   | PZ         |                                   |  |      |             |     |     |          |                                |   |    |          |  |    |    |          |                      |   |    |          |                             |   |    |          |  |   |    |          |   |   |    |          |   |   |    |          |                             |   |    |          |   |    |    |          |                       |   |    |          |                         |   |    |
| PD1069A0  | FOOT<br>OVERLAP S5<br>CT-BT-E                      | 1   | PZ         |                                   |  |      |             |     |     |          |                                |   |    |          |  |    |    |          |                      |   |    |          |                             |   |    |          |  |   |    |          |   |   |    |          |   |   |    |          |                             |   |    |          |   |    |    |          |                       |   |    |          |                         |   |    |
| RC1008A0  | D9 ELASTIC<br>CLIP                                 | 3   | PZ         |                                   |  |      |             |     |     |          |                                |   |    |          |  |    |    |          |                      |   |    |          |                             |   |    |          |  |   |    |          |   |   |    |          |   |   |    |          |                             |   |    |          |   |    |    |          |                       |   |    |          |                         |   |    |
| RC1055A0  | Ø25-40 H12<br>STAINLESS<br>STEEL PIPE<br>CLIP      | 14  | PZ         |                                   |  |      |             |     |     |          |                                |   |    |          |  |    |    |          |                      |   |    |          |                             |   |    |          |  |   |    |          |   |   |    |          |   |   |    |          |                             |   |    |          |   |    |    |          |                       |   |    |          |                         |   |    |
| RC1130A0  | 130X2,6 CLAM                                       | 3   | PZ         |                                   |  |      |             |     |     |          |                                |   |    |          |  |    |    |          |                      |   |    |          |                             |   |    |          |  |   |    |          |   |   |    |          |   |   |    |          |                             |   |    |          |   |    |    |          |                       |   |    |          |                         |   |    |
| RC1297A1  | D10 T-SHAPED<br>FITTING                            | 1   | PZ         |                                   |  |      |             |     |     |          |                                |   |    |          |  |    |    |          |                      |   |    |          |                             |   |    |          |  |   |    |          |   |   |    |          |   |   |    |          |                             |   |    |          |   |    |    |          |                       |   |    |          |                         |   |    |

| COMPONENT |  |   | SPARE PART |                                 |  |      |             |     |     |          |              |   |    |          |   |   |   |          |   |   |    |          |              |       |   |          |                                      |   |    |          |  |   |    |          |                                |   |    |          |  |    |    |          |             |   |    |          |                 |   |    |          |   |   |    |          |   |   |    |          |   |   |    |          |                             |   |    |          |                                  |   |    |          |                       |   |    |       |                                       |   |      |             |     |     |          |                        |   |    |          |                           |   |    |          |                      |   |    |          |                             |   |    |
|-----------|--|---|------------|---------------------------------|--|------|-------------|-----|-----|----------|--------------|---|----|----------|---|---|---|----------|---|---|----|----------|--------------|-------|---|----------|--------------------------------------|---|----|----------|--|---|----|----------|--------------------------------|---|----|----------|--|----|----|----------|-------------|---|----|----------|-----------------|---|----|----------|---|---|----|----------|---|---|----|----------|---|---|----|----------|-----------------------------|---|----|----------|----------------------------------|---|----|----------|-----------------------|---|----|-------|---------------------------------------|---|------|-------------|-----|-----|----------|------------------------|---|----|----------|---------------------------|---|----|----------|----------------------|---|----|----------|-----------------------------|---|----|
| Code      | Description  | Image   | Code       | Description                     | Components list  |      |             |     |     |          |              |   |    |          |   |   |   |          |   |   |    |          |              |       |   |          |                                      |   |    |          |  |   |    |          |                                |   |    |          |  |    |    |          |             |   |    |          |                 |   |    |          |   |   |    |          |   |   |    |          |   |   |    |          |                             |   |    |          |                                  |   |    |          |                       |   |    |       |                                       |   |      |             |     |     |          |                        |   |    |          |                           |   |    |          |                      |   |    |          |                             |   |    |
| VL1006A   | SYPHON COVER                                       |  | XC756      | E SERIES GN 2/3<br>STACKING KIT | <table border="1"> <thead> <tr> <th>Code</th> <th>Description</th> <th>Qty</th> <th>UOM</th> </tr> </thead> <tbody> <tr> <td>RC1376A0</td> <td>Ø6 Y-FITTING</td> <td>1</td> <td>PZ</td> </tr> <tr> <td>TB1520A0</td> <td>INT. Ø=38<br/>TH=4 DRAIN<br/>BLACK<br/>RUBBER PIPE</td> <td>3</td> <td>M</td> </tr> <tr> <td>TB1765A1</td> <td>STACKING KIT<br/>CHIMNEY<br/>CONNECTING<br/>PIPE</td> <td>1</td> <td>PZ</td> </tr> <tr> <td>TB2243A0</td> <td>Ø10 PET PIPE</td> <td>1.500</td> <td>M</td> </tr> <tr> <td>VI1220A1</td> <td>4,2X12 TCB<br/>SELF-TAPPIN<br/>G SCREW</td> <td>4</td> <td>PZ</td> </tr> <tr> <td>VI1895A0</td> <td>BLIND NUT M4<br/>STAINLESS<br/>STEEL DIN 917</td> <td>8</td> <td>PZ</td> </tr> <tr> <td>VI1945A0</td> <td>ENG-VITE<br/>M4X20 TCB+<br/>INOX</td> <td>8</td> <td>PZ</td> </tr> <tr> <td>VI1950A0</td> <td>ST. STEEL<br/>4,2X13 TCB<br/>SELF-DRILLIN<br/>G SCREW</td> <td>26</td> <td>PZ</td> </tr> <tr> <td>VL1005A1</td> <td>U-TRAP TANK</td> <td>2</td> <td>PZ</td> </tr> <tr> <td>VL1006A0</td> <td>SYPHON<br/>COVER</td> <td>2</td> <td>PZ</td> </tr> <tr> <td>VL1043A0</td> <td>D4 PIPE<br/>HOLDER - D6<br/>J.G. TERMINAL</td> <td>3</td> <td>PZ</td> </tr> <tr> <td>VL1046A1</td> <td>D6 PIPE<br/>HOLDER - D6<br/>J.G. TERMINAL</td> <td>3</td> <td>PZ</td> </tr> <tr> <td>VM1015A1</td> <td>STAINLESS<br/>STEEL<br/>Ø30X1.5 90°<br/>BEND</td> <td>1</td> <td>PZ</td> </tr> <tr> <td>VM1794A0</td> <td>250X4.8 PA66<br/>BLACK CLAMP</td> <td>3</td> <td>PZ</td> </tr> <tr> <td>VM1987A0</td> <td>BRACKET FOR<br/>OVENS<br/>STACKING</td> <td>1</td> <td>PZ</td> </tr> <tr> <td>VM2035A0</td> <td>DRAIN PIPE<br/>SUPPORT</td> <td>1</td> <td>PZ</td> </tr> </tbody> </table> | Code | Description | Qty | UOM | RC1376A0 | Ø6 Y-FITTING | 1 | PZ | TB1520A0 | INT. Ø=38<br>TH=4 DRAIN<br>BLACK<br>RUBBER PIPE | 3 | M | TB1765A1 | STACKING KIT<br>CHIMNEY<br>CONNECTING<br>PIPE | 1 | PZ | TB2243A0 | Ø10 PET PIPE | 1.500 | M | VI1220A1 | 4,2X12 TCB<br>SELF-TAPPIN<br>G SCREW | 4 | PZ | VI1895A0 | BLIND NUT M4<br>STAINLESS<br>STEEL DIN 917 | 8 | PZ | VI1945A0 | ENG-VITE<br>M4X20 TCB+<br>INOX | 8 | PZ | VI1950A0 | ST. STEEL<br>4,2X13 TCB<br>SELF-DRILLIN<br>G SCREW | 26 | PZ | VL1005A1 | U-TRAP TANK | 2 | PZ | VL1006A0 | SYPHON<br>COVER | 2 | PZ | VL1043A0 | D4 PIPE<br>HOLDER - D6<br>J.G. TERMINAL | 3 | PZ | VL1046A1 | D6 PIPE<br>HOLDER - D6<br>J.G. TERMINAL | 3 | PZ | VM1015A1 | STAINLESS<br>STEEL<br>Ø30X1.5 90°<br>BEND | 1 | PZ | VM1794A0 | 250X4.8 PA66<br>BLACK CLAMP | 3 | PZ | VM1987A0 | BRACKET FOR<br>OVENS<br>STACKING | 1 | PZ | VM2035A0 | DRAIN PIPE<br>SUPPORT | 1 | PZ | XC755 | E SERIES BT-CT GN<br>2/1 STACKING KIT | <table border="1"> <thead> <tr> <th>Code</th> <th>Description</th> <th>Qty</th> <th>UOM</th> </tr> </thead> <tbody> <tr> <td>0H6461A0</td> <td>XC755 FRONT<br/>PROFILE</td> <td>1</td> <td>PZ</td> </tr> <tr> <td>CE1635A0</td> <td>RJ45 - RJ45<br/>CABLE L=3M</td> <td>1</td> <td>PZ</td> </tr> <tr> <td>ED1246A0</td> <td>HOT SURFACE<br/>LABEL</td> <td>2</td> <td>PZ</td> </tr> <tr> <td>ED1271A0</td> <td>LIQUID FALLS<br/>DANGER LABE</td> <td>1</td> <td>PZ</td> </tr> </tbody> </table> | Code | Description | Qty | UOM | 0H6461A0 | XC755 FRONT<br>PROFILE | 1 | PZ | CE1635A0 | RJ45 - RJ45<br>CABLE L=3M | 1 | PZ | ED1246A0 | HOT SURFACE<br>LABEL | 2 | PZ | ED1271A0 | LIQUID FALLS<br>DANGER LABE | 1 | PZ |
|           |  |   | Code       | Description                     | Qty  | UOM  |             |     |     |          |              |   |    |          |   |   |   |          |   |   |    |          |              |       |   |          |                                      |   |    |          |  |   |    |          |                                |   |    |          |  |    |    |          |             |   |    |          |                 |   |    |          |   |   |    |          |   |   |    |          |   |   |    |          |                             |   |    |          |                                  |   |    |          |                       |   |    |       |                                       |   |      |             |     |     |          |                        |   |    |          |                           |   |    |          |                      |   |    |          |                             |   |    |
| RC1376A0  | Ø6 Y-FITTING                                       | 1   | PZ         |                                 |  |      |             |     |     |          |              |   |    |          |   |   |   |          |   |   |    |          |              |       |   |          |                                      |   |    |          |  |   |    |          |                                |   |    |          |  |    |    |          |             |   |    |          |                 |   |    |          |   |   |    |          |   |   |    |          |   |   |    |          |                             |   |    |          |                                  |   |    |          |                       |   |    |       |                                       |   |      |             |     |     |          |                        |   |    |          |                           |   |    |          |                      |   |    |          |                             |   |    |
| TB1520A0  | INT. Ø=38<br>TH=4 DRAIN<br>BLACK<br>RUBBER PIPE    | 3   | M          |                                 |  |      |             |     |     |          |              |   |    |          |   |   |   |          |   |   |    |          |              |       |   |          |                                      |   |    |          |  |   |    |          |                                |   |    |          |  |    |    |          |             |   |    |          |                 |   |    |          |   |   |    |          |   |   |    |          |   |   |    |          |                             |   |    |          |                                  |   |    |          |                       |   |    |       |                                       |   |      |             |     |     |          |                        |   |    |          |                           |   |    |          |                      |   |    |          |                             |   |    |
| TB1765A1  | STACKING KIT<br>CHIMNEY<br>CONNECTING<br>PIPE      | 1   | PZ         |                                 |  |      |             |     |     |          |              |   |    |          |   |   |   |          |   |   |    |          |              |       |   |          |                                      |   |    |          |  |   |    |          |                                |   |    |          |  |    |    |          |             |   |    |          |                 |   |    |          |   |   |    |          |   |   |    |          |   |   |    |          |                             |   |    |          |                                  |   |    |          |                       |   |    |       |                                       |   |      |             |     |     |          |                        |   |    |          |                           |   |    |          |                      |   |    |          |                             |   |    |
| TB2243A0  | Ø10 PET PIPE                                       | 1.500   | M          |                                 |  |      |             |     |     |          |              |   |    |          |   |   |   |          |   |   |    |          |              |       |   |          |                                      |   |    |          |  |   |    |          |                                |   |    |          |  |    |    |          |             |   |    |          |                 |   |    |          |   |   |    |          |   |   |    |          |   |   |    |          |                             |   |    |          |                                  |   |    |          |                       |   |    |       |                                       |   |      |             |     |     |          |                        |   |    |          |                           |   |    |          |                      |   |    |          |                             |   |    |
| VI1220A1  | 4,2X12 TCB<br>SELF-TAPPIN<br>G SCREW               | 4   | PZ         |                                 |  |      |             |     |     |          |              |   |    |          |   |   |   |          |   |   |    |          |              |       |   |          |                                      |   |    |          |  |   |    |          |                                |   |    |          |  |    |    |          |             |   |    |          |                 |   |    |          |   |   |    |          |   |   |    |          |   |   |    |          |                             |   |    |          |                                  |   |    |          |                       |   |    |       |                                       |   |      |             |     |     |          |                        |   |    |          |                           |   |    |          |                      |   |    |          |                             |   |    |
| VI1895A0  | BLIND NUT M4<br>STAINLESS<br>STEEL DIN 917         | 8   | PZ         |                                 |  |      |             |     |     |          |              |   |    |          |   |   |   |          |   |   |    |          |              |       |   |          |                                      |   |    |          |  |   |    |          |                                |   |    |          |  |    |    |          |             |   |    |          |                 |   |    |          |   |   |    |          |   |   |    |          |   |   |    |          |                             |   |    |          |                                  |   |    |          |                       |   |    |       |                                       |   |      |             |     |     |          |                        |   |    |          |                           |   |    |          |                      |   |    |          |                             |   |    |
| VI1945A0  | ENG-VITE<br>M4X20 TCB+<br>INOX                     | 8   | PZ         |                                 |  |      |             |     |     |          |              |   |    |          |   |   |   |          |   |   |    |          |              |       |   |          |                                      |   |    |          |  |   |    |          |                                |   |    |          |  |    |    |          |             |   |    |          |                 |   |    |          |   |   |    |          |   |   |    |          |   |   |    |          |                             |   |    |          |                                  |   |    |          |                       |   |    |       |                                       |   |      |             |     |     |          |                        |   |    |          |                           |   |    |          |                      |   |    |          |                             |   |    |
| VI1950A0  | ST. STEEL<br>4,2X13 TCB<br>SELF-DRILLIN<br>G SCREW | 26  | PZ         |                                 |  |      |             |     |     |          |              |   |    |          |   |   |   |          |   |   |    |          |              |       |   |          |                                      |   |    |          |  |   |    |          |                                |   |    |          |  |    |    |          |             |   |    |          |                 |   |    |          |   |   |    |          |   |   |    |          |   |   |    |          |                             |   |    |          |                                  |   |    |          |                       |   |    |       |                                       |   |      |             |     |     |          |                        |   |    |          |                           |   |    |          |                      |   |    |          |                             |   |    |
| VL1005A1  | U-TRAP TANK  | 2   | PZ         |                                 |  |      |             |     |     |          |              |   |    |          |   |   |   |          |   |   |    |          |              |       |   |          |                                      |   |    |          |  |   |    |          |                                |   |    |          |  |    |    |          |             |   |    |          |                 |   |    |          |   |   |    |          |   |   |    |          |   |   |    |          |                             |   |    |          |                                  |   |    |          |                       |   |    |       |                                       |   |      |             |     |     |          |                        |   |    |          |                           |   |    |          |                      |   |    |          |                             |   |    |
| VL1006A0  | SYPHON<br>COVER                                    | 2   | PZ         |                                 |  |      |             |     |     |          |              |   |    |          |   |   |   |          |   |   |    |          |              |       |   |          |                                      |   |    |          |  |   |    |          |                                |   |    |          |  |    |    |          |             |   |    |          |                 |   |    |          |   |   |    |          |   |   |    |          |   |   |    |          |                             |   |    |          |                                  |   |    |          |                       |   |    |       |                                       |   |      |             |     |     |          |                        |   |    |          |                           |   |    |          |                      |   |    |          |                             |   |    |
| VL1043A0  | D4 PIPE<br>HOLDER - D6<br>J.G. TERMINAL            | 3   | PZ         |                                 |  |      |             |     |     |          |              |   |    |          |   |   |   |          |   |   |    |          |              |       |   |          |                                      |   |    |          |  |   |    |          |                                |   |    |          |  |    |    |          |             |   |    |          |                 |   |    |          |   |   |    |          |   |   |    |          |   |   |    |          |                             |   |    |          |                                  |   |    |          |                       |   |    |       |                                       |   |      |             |     |     |          |                        |   |    |          |                           |   |    |          |                      |   |    |          |                             |   |    |
| VL1046A1  | D6 PIPE<br>HOLDER - D6<br>J.G. TERMINAL            | 3   | PZ         |                                 |  |      |             |     |     |          |              |   |    |          |   |   |   |          |   |   |    |          |              |       |   |          |                                      |   |    |          |  |   |    |          |                                |   |    |          |  |    |    |          |             |   |    |          |                 |   |    |          |   |   |    |          |   |   |    |          |   |   |    |          |                             |   |    |          |                                  |   |    |          |                       |   |    |       |                                       |   |      |             |     |     |          |                        |   |    |          |                           |   |    |          |                      |   |    |          |                             |   |    |
| VM1015A1  | STAINLESS<br>STEEL<br>Ø30X1.5 90°<br>BEND          | 1   | PZ         |                                 |  |      |             |     |     |          |              |   |    |          |   |   |   |          |   |   |    |          |              |       |   |          |                                      |   |    |          |  |   |    |          |                                |   |    |          |  |    |    |          |             |   |    |          |                 |   |    |          |   |   |    |          |   |   |    |          |   |   |    |          |                             |   |    |          |                                  |   |    |          |                       |   |    |       |                                       |   |      |             |     |     |          |                        |   |    |          |                           |   |    |          |                      |   |    |          |                             |   |    |
| VM1794A0  | 250X4.8 PA66<br>BLACK CLAMP                        | 3   | PZ         |                                 |  |      |             |     |     |          |              |   |    |          |   |   |   |          |   |   |    |          |              |       |   |          |                                      |   |    |          |  |   |    |          |                                |   |    |          |  |    |    |          |             |   |    |          |                 |   |    |          |   |   |    |          |   |   |    |          |   |   |    |          |                             |   |    |          |                                  |   |    |          |                       |   |    |       |                                       |   |      |             |     |     |          |                        |   |    |          |                           |   |    |          |                      |   |    |          |                             |   |    |
| VM1987A0  | BRACKET FOR<br>OVENS<br>STACKING                   | 1   | PZ         |                                 |  |      |             |     |     |          |              |   |    |          |   |   |   |          |   |   |    |          |              |       |   |          |                                      |   |    |          |  |   |    |          |                                |   |    |          |  |    |    |          |             |   |    |          |                 |   |    |          |   |   |    |          |   |   |    |          |   |   |    |          |                             |   |    |          |                                  |   |    |          |                       |   |    |       |                                       |   |      |             |     |     |          |                        |   |    |          |                           |   |    |          |                      |   |    |          |                             |   |    |
| VM2035A0  | DRAIN PIPE<br>SUPPORT                              | 1   | PZ         |                                 |  |      |             |     |     |          |              |   |    |          |   |   |   |          |   |   |    |          |              |       |   |          |                                      |   |    |          |  |   |    |          |                                |   |    |          |  |    |    |          |             |   |    |          |                 |   |    |          |   |   |    |          |   |   |    |          |   |   |    |          |                             |   |    |          |                                  |   |    |          |                       |   |    |       |                                       |   |      |             |     |     |          |                        |   |    |          |                           |   |    |          |                      |   |    |          |                             |   |    |
| Code      | Description  | Qty   | UOM        |                                 |  |      |             |     |     |          |              |   |    |          |   |   |   |          |   |   |    |          |              |       |   |          |                                      |   |    |          |  |   |    |          |                                |   |    |          |  |    |    |          |             |   |    |          |                 |   |    |          |   |   |    |          |   |   |    |          |   |   |    |          |                             |   |    |          |                                  |   |    |          |                       |   |    |       |                                       |   |      |             |     |     |          |                        |   |    |          |                           |   |    |          |                      |   |    |          |                             |   |    |
| 0H6461A0  | XC755 FRONT<br>PROFILE                             | 1   | PZ         |                                 |  |      |             |     |     |          |              |   |    |          |   |   |   |          |   |   |    |          |              |       |   |          |                                      |   |    |          |  |   |    |          |                                |   |    |          |  |    |    |          |             |   |    |          |                 |   |    |          |   |   |    |          |   |   |    |          |   |   |    |          |                             |   |    |          |                                  |   |    |          |                       |   |    |       |                                       |   |      |             |     |     |          |                        |   |    |          |                           |   |    |          |                      |   |    |          |                             |   |    |
| CE1635A0  | RJ45 - RJ45<br>CABLE L=3M                          | 1   | PZ         |                                 |  |      |             |     |     |          |              |   |    |          |   |   |   |          |   |   |    |          |              |       |   |          |                                      |   |    |          |  |   |    |          |                                |   |    |          |  |    |    |          |             |   |    |          |                 |   |    |          |   |   |    |          |   |   |    |          |   |   |    |          |                             |   |    |          |                                  |   |    |          |                       |   |    |       |                                       |   |      |             |     |     |          |                        |   |    |          |                           |   |    |          |                      |   |    |          |                             |   |    |
| ED1246A0  | HOT SURFACE<br>LABEL                               | 2   | PZ         |                                 |  |      |             |     |     |          |              |   |    |          |   |   |   |          |   |   |    |          |              |       |   |          |                                      |   |    |          |  |   |    |          |                                |   |    |          |  |    |    |          |             |   |    |          |                 |   |    |          |   |   |    |          |   |   |    |          |   |   |    |          |                             |   |    |          |                                  |   |    |          |                       |   |    |       |                                       |   |      |             |     |     |          |                        |   |    |          |                           |   |    |          |                      |   |    |          |                             |   |    |
| ED1271A0  | LIQUID FALLS<br>DANGER LABE                        | 1   | PZ         |                                 |  |      |             |     |     |          |              |   |    |          |   |   |   |          |   |   |    |          |              |       |   |          |                                      |   |    |          |  |   |    |          |                                |   |    |          |  |    |    |          |             |   |    |          |                 |   |    |          |   |   |    |          |   |   |    |          |   |   |    |          |                             |   |    |          |                                  |   |    |          |                       |   |    |       |                                       |   |      |             |     |     |          |                        |   |    |          |                           |   |    |          |                      |   |    |          |                             |   |    |

| COMPONENT |   |   | SPARE PART |                                       |  |      |             |     |     |          |                                   |   |    |          |                        |   |    |          |                         |   |    |          |                 |   |    |          |                                      |    |    |          |              |   |    |          |                      |   |    |          |              |   |    |          |  |   |   |          |                                      |   |    |          |              |       |   |          |                                |   |    |          |                                      |   |    |          |                          |   |    |          |   |    |    |          |             |   |    |          |              |   |    |          |                                   |   |    |          |                                   |   |    |          |                                  |   |    |
|-----------|---|---|------------|---------------------------------------|--|------|-------------|-----|-----|----------|-----------------------------------|---|----|----------|------------------------|---|----|----------|-------------------------|---|----|----------|-----------------|---|----|----------|--------------------------------------|----|----|----------|--------------|---|----|----------|----------------------|---|----|----------|--------------|---|----|----------|--|---|---|----------|--------------------------------------|---|----|----------|--------------|-------|---|----------|--------------------------------|---|----|----------|--------------------------------------|---|----|----------|--------------------------|---|----|----------|---|----|----|----------|-------------|---|----|----------|--------------|---|----|----------|-----------------------------------|---|----|----------|-----------------------------------|---|----|----------|----------------------------------|---|----|
| Code      | Description                               | Image   | Code       | Description                           | Components list  |      |             |     |     |          |                                   |   |    |          |                        |   |    |          |                         |   |    |          |                 |   |    |          |                                      |    |    |          |              |   |    |          |                      |   |    |          |              |   |    |          |  |   |   |          |                                      |   |    |          |              |       |   |          |                                |   |    |          |                                      |   |    |          |                          |   |    |          |   |    |    |          |             |   |    |          |              |   |    |          |                                   |   |    |          |                                   |   |    |          |                                  |   |    |
| VL1006A   | SYPHON COVER                              |  | XC755      | E SERIES BT-CT GN<br>2/1 STACKING KIT | <table border="1"> <thead> <tr> <th>Code</th> <th>Description</th> <th>Qty</th> <th>UOM</th> </tr> </thead> <tbody> <tr> <td>EL1020A1</td> <td>D8 INTERMEDIAT E T-SHAPED FITTING</td> <td>2</td> <td>PZ</td> </tr> <tr> <td>GN1508A0</td> <td>O-RING GASKET COD 2400</td> <td>2</td> <td>PZ</td> </tr> <tr> <td>PD1069A0</td> <td>FOOT OVERLAP S5 CT-BT-E</td> <td>1</td> <td>PZ</td> </tr> <tr> <td>RC1008A0</td> <td>D9 ELASTIC CLIP</td> <td>3</td> <td>PZ</td> </tr> <tr> <td>RC1055A0</td> <td>Ø25-40 H12 STAINLESS STEEL PIPE CLIP</td> <td>14</td> <td>PZ</td> </tr> <tr> <td>RC1130A0</td> <td>130X2,6 CLAM</td> <td>3</td> <td>PZ</td> </tr> <tr> <td>RC1297A1</td> <td>D10 T-SHAPED FITTING</td> <td>1</td> <td>PZ</td> </tr> <tr> <td>RC1376A0</td> <td>Ø6 Y-FITTING</td> <td>1</td> <td>PZ</td> </tr> <tr> <td>TB1520A0</td> <td>INT. Ø=38 TH=4 DRAIN BLACK RUBBER PIPE</td> <td>5</td> <td>M</td> </tr> <tr> <td>TB1765A1</td> <td>STACKING KIT CHIMNEY CONNECTING PIPE</td> <td>2</td> <td>PZ</td> </tr> <tr> <td>TB2243A0</td> <td>Ø10 PET PIPE</td> <td>1.500</td> <td>M</td> </tr> <tr> <td>VI1220A1</td> <td>4,2X12 TCB SELF-TAPPIN G SCREW</td> <td>4</td> <td>PZ</td> </tr> <tr> <td>VI1895A0</td> <td>BLIND NUT M4 STAINLESS STEEL DIN 917</td> <td>8</td> <td>PZ</td> </tr> <tr> <td>VI1945A0</td> <td>ENG-VITE M4X20 TCB+ INOX</td> <td>8</td> <td>PZ</td> </tr> <tr> <td>VI1950A0</td> <td>ST. STEEL 4,2X13 TCB SELF-DRILLIN G SCREW</td> <td>26</td> <td>PZ</td> </tr> <tr> <td>VL1005A1</td> <td>U-TRAP TANK</td> <td>2</td> <td>PZ</td> </tr> <tr> <td>VL1006A0</td> <td>SYPHON COVER</td> <td>2</td> <td>PZ</td> </tr> <tr> <td>VL1043A0</td> <td>D4 PIPE HOLDER - D6 J.G. TERMINAL</td> <td>3</td> <td>PZ</td> </tr> <tr> <td>VL1046A1</td> <td>D6 PIPE HOLDER - D6 J.G. TERMINAL</td> <td>3</td> <td>PZ</td> </tr> <tr> <td>VM1015A1</td> <td>STAINLESS STEEL Ø30X1,5 90° BEND</td> <td>1</td> <td>PZ</td> </tr> </tbody> </table> | Code | Description | Qty | UOM | EL1020A1 | D8 INTERMEDIAT E T-SHAPED FITTING | 2 | PZ | GN1508A0 | O-RING GASKET COD 2400 | 2 | PZ | PD1069A0 | FOOT OVERLAP S5 CT-BT-E | 1 | PZ | RC1008A0 | D9 ELASTIC CLIP | 3 | PZ | RC1055A0 | Ø25-40 H12 STAINLESS STEEL PIPE CLIP | 14 | PZ | RC1130A0 | 130X2,6 CLAM | 3 | PZ | RC1297A1 | D10 T-SHAPED FITTING | 1 | PZ | RC1376A0 | Ø6 Y-FITTING | 1 | PZ | TB1520A0 | INT. Ø=38 TH=4 DRAIN BLACK RUBBER PIPE | 5 | M | TB1765A1 | STACKING KIT CHIMNEY CONNECTING PIPE | 2 | PZ | TB2243A0 | Ø10 PET PIPE | 1.500 | M | VI1220A1 | 4,2X12 TCB SELF-TAPPIN G SCREW | 4 | PZ | VI1895A0 | BLIND NUT M4 STAINLESS STEEL DIN 917 | 8 | PZ | VI1945A0 | ENG-VITE M4X20 TCB+ INOX | 8 | PZ | VI1950A0 | ST. STEEL 4,2X13 TCB SELF-DRILLIN G SCREW | 26 | PZ | VL1005A1 | U-TRAP TANK | 2 | PZ | VL1006A0 | SYPHON COVER | 2 | PZ | VL1043A0 | D4 PIPE HOLDER - D6 J.G. TERMINAL | 3 | PZ | VL1046A1 | D6 PIPE HOLDER - D6 J.G. TERMINAL | 3 | PZ | VM1015A1 | STAINLESS STEEL Ø30X1,5 90° BEND | 1 | PZ |
| Code      | Description                               | Qty   | UOM        |                                       |  |      |             |     |     |          |                                   |   |    |          |                        |   |    |          |                         |   |    |          |                 |   |    |          |                                      |    |    |          |              |   |    |          |                      |   |    |          |              |   |    |          |  |   |   |          |                                      |   |    |          |              |       |   |          |                                |   |    |          |                                      |   |    |          |                          |   |    |          |   |    |    |          |             |   |    |          |              |   |    |          |                                   |   |    |          |                                   |   |    |          |                                  |   |    |
| EL1020A1  | D8 INTERMEDIAT E T-SHAPED FITTING         | 2   | PZ         |                                       |  |      |             |     |     |          |                                   |   |    |          |                        |   |    |          |                         |   |    |          |                 |   |    |          |                                      |    |    |          |              |   |    |          |                      |   |    |          |              |   |    |          |  |   |   |          |                                      |   |    |          |              |       |   |          |                                |   |    |          |                                      |   |    |          |                          |   |    |          |   |    |    |          |             |   |    |          |              |   |    |          |                                   |   |    |          |                                   |   |    |          |                                  |   |    |
| GN1508A0  | O-RING GASKET COD 2400                    | 2   | PZ         |                                       |  |      |             |     |     |          |                                   |   |    |          |                        |   |    |          |                         |   |    |          |                 |   |    |          |                                      |    |    |          |              |   |    |          |                      |   |    |          |              |   |    |          |  |   |   |          |                                      |   |    |          |              |       |   |          |                                |   |    |          |                                      |   |    |          |                          |   |    |          |   |    |    |          |             |   |    |          |              |   |    |          |                                   |   |    |          |                                   |   |    |          |                                  |   |    |
| PD1069A0  | FOOT OVERLAP S5 CT-BT-E                   | 1   | PZ         |                                       |  |      |             |     |     |          |                                   |   |    |          |                        |   |    |          |                         |   |    |          |                 |   |    |          |                                      |    |    |          |              |   |    |          |                      |   |    |          |              |   |    |          |  |   |   |          |                                      |   |    |          |              |       |   |          |                                |   |    |          |                                      |   |    |          |                          |   |    |          |   |    |    |          |             |   |    |          |              |   |    |          |                                   |   |    |          |                                   |   |    |          |                                  |   |    |
| RC1008A0  | D9 ELASTIC CLIP                           | 3   | PZ         |                                       |  |      |             |     |     |          |                                   |   |    |          |                        |   |    |          |                         |   |    |          |                 |   |    |          |                                      |    |    |          |              |   |    |          |                      |   |    |          |              |   |    |          |  |   |   |          |                                      |   |    |          |              |       |   |          |                                |   |    |          |                                      |   |    |          |                          |   |    |          |   |    |    |          |             |   |    |          |              |   |    |          |                                   |   |    |          |                                   |   |    |          |                                  |   |    |
| RC1055A0  | Ø25-40 H12 STAINLESS STEEL PIPE CLIP      | 14  | PZ         |                                       |  |      |             |     |     |          |                                   |   |    |          |                        |   |    |          |                         |   |    |          |                 |   |    |          |                                      |    |    |          |              |   |    |          |                      |   |    |          |              |   |    |          |  |   |   |          |                                      |   |    |          |              |       |   |          |                                |   |    |          |                                      |   |    |          |                          |   |    |          |   |    |    |          |             |   |    |          |              |   |    |          |                                   |   |    |          |                                   |   |    |          |                                  |   |    |
| RC1130A0  | 130X2,6 CLAM                              | 3   | PZ         |                                       |  |      |             |     |     |          |                                   |   |    |          |                        |   |    |          |                         |   |    |          |                 |   |    |          |                                      |    |    |          |              |   |    |          |                      |   |    |          |              |   |    |          |  |   |   |          |                                      |   |    |          |              |       |   |          |                                |   |    |          |                                      |   |    |          |                          |   |    |          |   |    |    |          |             |   |    |          |              |   |    |          |                                   |   |    |          |                                   |   |    |          |                                  |   |    |
| RC1297A1  | D10 T-SHAPED FITTING                      | 1   | PZ         |                                       |  |      |             |     |     |          |                                   |   |    |          |                        |   |    |          |                         |   |    |          |                 |   |    |          |                                      |    |    |          |              |   |    |          |                      |   |    |          |              |   |    |          |  |   |   |          |                                      |   |    |          |              |       |   |          |                                |   |    |          |                                      |   |    |          |                          |   |    |          |   |    |    |          |             |   |    |          |              |   |    |          |                                   |   |    |          |                                   |   |    |          |                                  |   |    |
| RC1376A0  | Ø6 Y-FITTING                              | 1   | PZ         |                                       |  |      |             |     |     |          |                                   |   |    |          |                        |   |    |          |                         |   |    |          |                 |   |    |          |                                      |    |    |          |              |   |    |          |                      |   |    |          |              |   |    |          |  |   |   |          |                                      |   |    |          |              |       |   |          |                                |   |    |          |                                      |   |    |          |                          |   |    |          |   |    |    |          |             |   |    |          |              |   |    |          |                                   |   |    |          |                                   |   |    |          |                                  |   |    |
| TB1520A0  | INT. Ø=38 TH=4 DRAIN BLACK RUBBER PIPE    | 5   | M          |                                       |  |      |             |     |     |          |                                   |   |    |          |                        |   |    |          |                         |   |    |          |                 |   |    |          |                                      |    |    |          |              |   |    |          |                      |   |    |          |              |   |    |          |  |   |   |          |                                      |   |    |          |              |       |   |          |                                |   |    |          |                                      |   |    |          |                          |   |    |          |   |    |    |          |             |   |    |          |              |   |    |          |                                   |   |    |          |                                   |   |    |          |                                  |   |    |
| TB1765A1  | STACKING KIT CHIMNEY CONNECTING PIPE      | 2   | PZ         |                                       |  |      |             |     |     |          |                                   |   |    |          |                        |   |    |          |                         |   |    |          |                 |   |    |          |                                      |    |    |          |              |   |    |          |                      |   |    |          |              |   |    |          |  |   |   |          |                                      |   |    |          |              |       |   |          |                                |   |    |          |                                      |   |    |          |                          |   |    |          |   |    |    |          |             |   |    |          |              |   |    |          |                                   |   |    |          |                                   |   |    |          |                                  |   |    |
| TB2243A0  | Ø10 PET PIPE                              | 1.500   | M          |                                       |  |      |             |     |     |          |                                   |   |    |          |                        |   |    |          |                         |   |    |          |                 |   |    |          |                                      |    |    |          |              |   |    |          |                      |   |    |          |              |   |    |          |  |   |   |          |                                      |   |    |          |              |       |   |          |                                |   |    |          |                                      |   |    |          |                          |   |    |          |   |    |    |          |             |   |    |          |              |   |    |          |                                   |   |    |          |                                   |   |    |          |                                  |   |    |
| VI1220A1  | 4,2X12 TCB SELF-TAPPIN G SCREW            | 4   | PZ         |                                       |  |      |             |     |     |          |                                   |   |    |          |                        |   |    |          |                         |   |    |          |                 |   |    |          |                                      |    |    |          |              |   |    |          |                      |   |    |          |              |   |    |          |  |   |   |          |                                      |   |    |          |              |       |   |          |                                |   |    |          |                                      |   |    |          |                          |   |    |          |   |    |    |          |             |   |    |          |              |   |    |          |                                   |   |    |          |                                   |   |    |          |                                  |   |    |
| VI1895A0  | BLIND NUT M4 STAINLESS STEEL DIN 917      | 8   | PZ         |                                       |  |      |             |     |     |          |                                   |   |    |          |                        |   |    |          |                         |   |    |          |                 |   |    |          |                                      |    |    |          |              |   |    |          |                      |   |    |          |              |   |    |          |  |   |   |          |                                      |   |    |          |              |       |   |          |                                |   |    |          |                                      |   |    |          |                          |   |    |          |   |    |    |          |             |   |    |          |              |   |    |          |                                   |   |    |          |                                   |   |    |          |                                  |   |    |
| VI1945A0  | ENG-VITE M4X20 TCB+ INOX                  | 8   | PZ         |                                       |  |      |             |     |     |          |                                   |   |    |          |                        |   |    |          |                         |   |    |          |                 |   |    |          |                                      |    |    |          |              |   |    |          |                      |   |    |          |              |   |    |          |  |   |   |          |                                      |   |    |          |              |       |   |          |                                |   |    |          |                                      |   |    |          |                          |   |    |          |   |    |    |          |             |   |    |          |              |   |    |          |                                   |   |    |          |                                   |   |    |          |                                  |   |    |
| VI1950A0  | ST. STEEL 4,2X13 TCB SELF-DRILLIN G SCREW | 26  | PZ         |                                       |  |      |             |     |     |          |                                   |   |    |          |                        |   |    |          |                         |   |    |          |                 |   |    |          |                                      |    |    |          |              |   |    |          |                      |   |    |          |              |   |    |          |  |   |   |          |                                      |   |    |          |              |       |   |          |                                |   |    |          |                                      |   |    |          |                          |   |    |          |   |    |    |          |             |   |    |          |              |   |    |          |                                   |   |    |          |                                   |   |    |          |                                  |   |    |
| VL1005A1  | U-TRAP TANK                               | 2   | PZ         |                                       |  |      |             |     |     |          |                                   |   |    |          |                        |   |    |          |                         |   |    |          |                 |   |    |          |                                      |    |    |          |              |   |    |          |                      |   |    |          |              |   |    |          |  |   |   |          |                                      |   |    |          |              |       |   |          |                                |   |    |          |                                      |   |    |          |                          |   |    |          |   |    |    |          |             |   |    |          |              |   |    |          |                                   |   |    |          |                                   |   |    |          |                                  |   |    |
| VL1006A0  | SYPHON COVER                              | 2   | PZ         |                                       |  |      |             |     |     |          |                                   |   |    |          |                        |   |    |          |                         |   |    |          |                 |   |    |          |                                      |    |    |          |              |   |    |          |                      |   |    |          |              |   |    |          |  |   |   |          |                                      |   |    |          |              |       |   |          |                                |   |    |          |                                      |   |    |          |                          |   |    |          |   |    |    |          |             |   |    |          |              |   |    |          |                                   |   |    |          |                                   |   |    |          |                                  |   |    |
| VL1043A0  | D4 PIPE HOLDER - D6 J.G. TERMINAL         | 3   | PZ         |                                       |  |      |             |     |     |          |                                   |   |    |          |                        |   |    |          |                         |   |    |          |                 |   |    |          |                                      |    |    |          |              |   |    |          |                      |   |    |          |              |   |    |          |  |   |   |          |                                      |   |    |          |              |       |   |          |                                |   |    |          |                                      |   |    |          |                          |   |    |          |   |    |    |          |             |   |    |          |              |   |    |          |                                   |   |    |          |                                   |   |    |          |                                  |   |    |
| VL1046A1  | D6 PIPE HOLDER - D6 J.G. TERMINAL         | 3   | PZ         |                                       |  |      |             |     |     |          |                                   |   |    |          |                        |   |    |          |                         |   |    |          |                 |   |    |          |                                      |    |    |          |              |   |    |          |                      |   |    |          |              |   |    |          |  |   |   |          |                                      |   |    |          |              |       |   |          |                                |   |    |          |                                      |   |    |          |                          |   |    |          |   |    |    |          |             |   |    |          |              |   |    |          |                                   |   |    |          |                                   |   |    |          |                                  |   |    |
| VM1015A1  | STAINLESS STEEL Ø30X1,5 90° BEND          | 1   | PZ         |                                       |  |      |             |     |     |          |                                   |   |    |          |                        |   |    |          |                         |   |    |          |                 |   |    |          |                                      |    |    |          |              |   |    |          |                      |   |    |          |              |   |    |          |  |   |   |          |                                      |   |    |          |              |       |   |          |                                |   |    |          |                                      |   |    |          |                          |   |    |          |   |    |    |          |             |   |    |          |              |   |    |          |                                   |   |    |          |                                   |   |    |          |                                  |   |    |

| COMPONENT |  |  | SPARE PART |                                       |   |      |             |                              |     |          |                             |   |    |          |                                  |   |    |          |                       |   |       |   |          |                                      |   |    |          |  |   |    |          |                                |   |    |          |  |   |    |
|-----------|--|--|------------|---------------------------------------|---|------|-------------|------------------------------|-----|----------|-----------------------------|---|----|----------|----------------------------------|---|----|----------|-----------------------|---|-------|---|----------|--------------------------------------|---|----|----------|--|---|----|----------|--------------------------------|---|----|----------|--|---|----|
| Code      | Description  | Image  | Code       | Description                           | Components list   |      |             |                              |     |          |                             |   |    |          |                                  |   |    |          |                       |   |       |   |          |                                      |   |    |          |  |   |    |          |                                |   |    |          |  |   |    |
| VL1006A   | SYPHON COVER                                       |   | XC755      | E SERIES BT-CT GN<br>2/1 STACKING KIT | <table border="1"> <thead> <tr> <th>Code</th> <th>Description</th> <th>Qty</th> <th>UOM</th> </tr> </thead> <tbody> <tr> <td>VM1794A0</td> <td>250X4.8 PA66<br/>BLACK CLAMP</td> <td>3</td> <td>PZ</td> </tr> <tr> <td>VM1987A0</td> <td>BRACKET FOR<br/>OVENS<br/>STACKING</td> <td>1</td> <td>PZ</td> </tr> <tr> <td>VM2035A0</td> <td>DRAIN PIPE<br/>SUPPORT</td> <td>2</td> <td>PZ</td> </tr> </tbody> </table> | Code | Description | Qty                          | UOM | VM1794A0 | 250X4.8 PA66<br>BLACK CLAMP | 3   | PZ | VM1987A0 | BRACKET FOR<br>OVENS<br>STACKING | 1   | PZ | VM2035A0 | DRAIN PIPE<br>SUPPORT | 2   | PZ    |   |          |                                      |   |    |          |  |   |    |          |                                |   |    |          |  |   |    |
|           |  |  | Code       | Description                           | Qty   | UOM  |             |                              |     |          |                             |   |    |          |                                  |   |    |          |                       |   |       |   |          |                                      |   |    |          |  |   |    |          |                                |   |    |          |  |   |    |
| VM1794A0  | 250X4.8 PA66<br>BLACK CLAMP                        | 3  | PZ         |                                       |   |      |             |                              |     |          |                             |   |    |          |                                  |   |    |          |                       |   |       |   |          |                                      |   |    |          |  |   |    |          |                                |   |    |          |  |   |    |
| VM1987A0  | BRACKET FOR<br>OVENS<br>STACKING                   | 1  | PZ         |                                       |   |      |             |                              |     |          |                             |   |    |          |                                  |   |    |          |                       |   |       |   |          |                                      |   |    |          |  |   |    |          |                                |   |    |          |  |   |    |
| VM2035A0  | DRAIN PIPE<br>SUPPORT                              | 2  | PZ         |                                       |   |      |             |                              |     |          |                             |   |    |          |                                  |   |    |          |                       |   |       |   |          |                                      |   |    |          |  |   |    |          |                                |   |    |          |  |   |    |
| XC699     | LINEMISS TOP<br>FIRST<br>INSTALLATION KIT          | <table border="1"> <thead> <tr> <th>Code</th> <th>Description</th> <th>Qty</th> <th>UOM</th> </tr> </thead> <tbody> <tr> <td>0H1237A0</td> <td>LM TOP<br/>SIPHON<br/>SUPPORT</td> <td>1</td> <td>PZ</td> </tr> <tr> <td>GN1508A0</td> <td>O-RING<br/>GASKET COD<br/>2400</td> <td>1</td> <td>PZ</td> </tr> <tr> <td>RC1055A0</td> <td>Ø25-40 H12<br/>STAINLESS<br/>STEEL PIPE<br/>CLIP</td> <td>4</td> <td>PZ</td> </tr> <tr> <td>TB1520A0</td> <td>INT. Ø=38<br/>TH=4 DRAIN<br/>BLACK<br/>RUBBER PIPE</td> <td>2.500</td> <td>M</td> </tr> <tr> <td>VI1220A1</td> <td>4,2X12 TCB<br/>SELF-TAPPIN<br/>G SCREW</td> <td>2</td> <td>PZ</td> </tr> <tr> <td>VI1895A0</td> <td>BLIND NUT M4<br/>STAINLESS<br/>STEEL DIN 917</td> <td>4</td> <td>PZ</td> </tr> <tr> <td>VI1945A0</td> <td>ENG-VITE<br/>M4X20 TCB+<br/>INOX</td> <td>4</td> <td>PZ</td> </tr> <tr> <td>VI1950A0</td> <td>ST. STEEL<br/>4,2X13 TCB<br/>SELF-DRILLIN<br/>G SCREW</td> <td>2</td> <td>PZ</td> </tr> </tbody> </table> | Code       | Description                           | Qty   | UOM  | 0H1237A0    | LM TOP<br>SIPHON<br>SUPPORT  | 1   | PZ       | GN1508A0                    | O-RING<br>GASKET COD<br>2400                  | 1  | PZ       | RC1055A0                         | Ø25-40 H12<br>STAINLESS<br>STEEL PIPE<br>CLIP | 4  | PZ       | TB1520A0              | INT. Ø=38<br>TH=4 DRAIN<br>BLACK<br>RUBBER PIPE | 2.500 | M | VI1220A1 | 4,2X12 TCB<br>SELF-TAPPIN<br>G SCREW | 2 | PZ | VI1895A0 | BLIND NUT M4<br>STAINLESS<br>STEEL DIN 917 | 4 | PZ | VI1945A0 | ENG-VITE<br>M4X20 TCB+<br>INOX | 4 | PZ | VI1950A0 | ST. STEEL<br>4,2X13 TCB<br>SELF-DRILLIN<br>G SCREW | 2 | PZ |
| Code      | Description  | Qty  | UOM        |                                       |   |      |             |                              |     |          |                             |   |    |          |                                  |   |    |          |                       |   |       |   |          |                                      |   |    |          |  |   |    |          |                                |   |    |          |  |   |    |
| 0H1237A0  | LM TOP<br>SIPHON<br>SUPPORT                        | 1  | PZ         |                                       |   |      |             |                              |     |          |                             |   |    |          |                                  |   |    |          |                       |   |       |   |          |                                      |   |    |          |  |   |    |          |                                |   |    |          |  |   |    |
| GN1508A0  | O-RING<br>GASKET COD<br>2400                       | 1  | PZ         |                                       |   |      |             |                              |     |          |                             |   |    |          |                                  |   |    |          |                       |   |       |   |          |                                      |   |    |          |  |   |    |          |                                |   |    |          |  |   |    |
| RC1055A0  | Ø25-40 H12<br>STAINLESS<br>STEEL PIPE<br>CLIP      | 4  | PZ         |                                       |   |      |             |                              |     |          |                             |   |    |          |                                  |   |    |          |                       |   |       |   |          |                                      |   |    |          |  |   |    |          |                                |   |    |          |  |   |    |
| TB1520A0  | INT. Ø=38<br>TH=4 DRAIN<br>BLACK<br>RUBBER PIPE    | 2.500  | M          |                                       |   |      |             |                              |     |          |                             |   |    |          |                                  |   |    |          |                       |   |       |   |          |                                      |   |    |          |  |   |    |          |                                |   |    |          |  |   |    |
| VI1220A1  | 4,2X12 TCB<br>SELF-TAPPIN<br>G SCREW               | 2  | PZ         |                                       |   |      |             |                              |     |          |                             |   |    |          |                                  |   |    |          |                       |   |       |   |          |                                      |   |    |          |  |   |    |          |                                |   |    |          |  |   |    |
| VI1895A0  | BLIND NUT M4<br>STAINLESS<br>STEEL DIN 917         | 4  | PZ         |                                       |   |      |             |                              |     |          |                             |   |    |          |                                  |   |    |          |                       |   |       |   |          |                                      |   |    |          |  |   |    |          |                                |   |    |          |  |   |    |
| VI1945A0  | ENG-VITE<br>M4X20 TCB+<br>INOX                     | 4  | PZ         |                                       |   |      |             |                              |     |          |                             |   |    |          |                                  |   |    |          |                       |   |       |   |          |                                      |   |    |          |  |   |    |          |                                |   |    |          |  |   |    |
| VI1950A0  | ST. STEEL<br>4,2X13 TCB<br>SELF-DRILLIN<br>G SCREW | 2  | PZ         |                                       |   |      |             |                              |     |          |                             |   |    |          |                                  |   |    |          |                       |   |       |   |          |                                      |   |    |          |  |   |    |          |                                |   |    |          |  |   |    |
| XC673     | COMPLETE P-TRAP<br>KIT                             | <table border="1"> <thead> <tr> <th>Code</th> <th>Description</th> <th>Qty</th> <th>UOM</th> </tr> </thead> <tbody> <tr> <td>GN1508A0</td> <td>O-RING<br/>GASKET COD<br/>2400</td> <td>1</td> <td>PZ</td> </tr> <tr> <td>RC1055A0</td> <td>Ø25-40 H12<br/>STAINLESS<br/>STEEL PIPE<br/>CLIP</td> <td>2</td> <td>PZ</td> </tr> </tbody> </table>  | Code       | Description                           | Qty   | UOM  | GN1508A0    | O-RING<br>GASKET COD<br>2400 | 1   | PZ       | RC1055A0                    | Ø25-40 H12<br>STAINLESS<br>STEEL PIPE<br>CLIP | 2  | PZ       |                                  |   |    |          |                       |   |       |   |          |                                      |   |    |          |  |   |    |          |                                |   |    |          |  |   |    |
| Code      | Description  | Qty  | UOM        |                                       |   |      |             |                              |     |          |                             |   |    |          |                                  |   |    |          |                       |   |       |   |          |                                      |   |    |          |  |   |    |          |                                |   |    |          |  |   |    |
| GN1508A0  | O-RING<br>GASKET COD<br>2400                       | 1  | PZ         |                                       |   |      |             |                              |     |          |                             |   |    |          |                                  |   |    |          |                       |   |       |   |          |                                      |   |    |          |  |   |    |          |                                |   |    |          |  |   |    |
| RC1055A0  | Ø25-40 H12<br>STAINLESS<br>STEEL PIPE<br>CLIP      | 2  | PZ         |                                       |   |      |             |                              |     |          |                             |   |    |          |                                  |   |    |          |                       |   |       |   |          |                                      |   |    |          |  |   |    |          |                                |   |    |          |  |   |    |

| COMPONENT |  |   | SPARE PART |                     |  |      |             |                             |     |          |   |                                    |   |          |                                      |  |    |          |  |                      |    |          |                                |                             |    |          |  |  |    |          |             |   |    |          |                 |                              |    |    |          |                    |   |    |          |   |    |    |          |                         |   |    |          |                            |   |    |
|-----------|--|---|------------|---------------------|--|------|-------------|-----------------------------|-----|----------|---|------------------------------------|---|----------|--------------------------------------|--|----|----------|--|----------------------|----|----------|--------------------------------|-----------------------------|----|----------|--|--|----|----------|-------------|---|----|----------|-----------------|------------------------------|----|----|----------|--------------------|---|----|----------|---|----|----|----------|-------------------------|---|----|----------|----------------------------|---|----|
| Code      | Description  | Image   | Code       | Description         | Components list  |      |             |                             |     |          |   |                                    |   |          |                                      |  |    |          |  |                      |    |          |                                |                             |    |          |  |  |    |          |             |   |    |          |                 |                              |    |    |          |                    |   |    |          |   |    |    |          |                         |   |    |          |                            |   |    |
| VL1006A   | SYPHON COVER                                       |    | XC673      | COMPLETE P-TRAP KIT | <table border="1"> <thead> <tr> <th>Code</th> <th>Description</th> <th>Qty</th> <th>UOM</th> </tr> </thead> <tbody> <tr> <td>TB1520A0</td> <td>INT. Ø=38<br/>TH=4 DRAIN<br/>BLACK<br/>RUBBER PIPE</td> <td>0.050</td> <td>M</td> </tr> <tr> <td>VI1220A1</td> <td>4,2X12 TCB<br/>SELF-TAPPIN<br/>G SCREW</td> <td>2</td> <td>PZ</td> </tr> <tr> <td>VI1895A0</td> <td>BLIND NUT M4<br/>STAINLESS<br/>STEEL DIN 917</td> <td>4</td> <td>PZ</td> </tr> <tr> <td>VI1945A0</td> <td>ENG-VITE<br/>M4X20 TCB+<br/>INOX</td> <td>4</td> <td>PZ</td> </tr> <tr> <td>VI1950A0</td> <td>ST. STEEL<br/>4,2X13 TCB<br/>SELF-DRILLIN<br/>G SCREW</td> <td>2</td> <td>PZ</td> </tr> <tr> <td>VL1005A1</td> <td>U-TRAP TANK</td> <td>1</td> <td>PZ</td> </tr> <tr> <td>VL1006A0</td> <td>SYPHON<br/>COVER</td> <td>1</td> <td>PZ</td> </tr> </tbody> </table> | Code | Description | Qty                         | UOM | TB1520A0 | INT. Ø=38<br>TH=4 DRAIN<br>BLACK<br>RUBBER PIPE | 0.050                              | M | VI1220A1 | 4,2X12 TCB<br>SELF-TAPPIN<br>G SCREW | 2  | PZ | VI1895A0 | BLIND NUT M4<br>STAINLESS<br>STEEL DIN 917 | 4                    | PZ | VI1945A0 | ENG-VITE<br>M4X20 TCB+<br>INOX | 4                           | PZ | VI1950A0 | ST. STEEL<br>4,2X13 TCB<br>SELF-DRILLIN<br>G SCREW | 2  | PZ | VL1005A1 | U-TRAP TANK | 1   | PZ | VL1006A0 | SYPHON<br>COVER | 1                            | PZ |    |          |                    |   |    |          |   |    |    |          |                         |   |    |          |                            |   |    |
|           |  |   | Code       | Description         | Qty  | UOM  |             |                             |     |          |   |                                    |   |          |                                      |  |    |          |  |                      |    |          |                                |                             |    |          |  |  |    |          |             |   |    |          |                 |                              |    |    |          |                    |   |    |          |   |    |    |          |                         |   |    |          |                            |   |    |
| TB1520A0  | INT. Ø=38<br>TH=4 DRAIN<br>BLACK<br>RUBBER PIPE    | 0.050   | M          |                     |  |      |             |                             |     |          |   |                                    |   |          |                                      |  |    |          |  |                      |    |          |                                |                             |    |          |  |  |    |          |             |   |    |          |                 |                              |    |    |          |                    |   |    |          |   |    |    |          |                         |   |    |          |                            |   |    |
| VI1220A1  | 4,2X12 TCB<br>SELF-TAPPIN<br>G SCREW               | 2   | PZ         |                     |  |      |             |                             |     |          |   |                                    |   |          |                                      |  |    |          |  |                      |    |          |                                |                             |    |          |  |  |    |          |             |   |    |          |                 |                              |    |    |          |                    |   |    |          |   |    |    |          |                         |   |    |          |                            |   |    |
| VI1895A0  | BLIND NUT M4<br>STAINLESS<br>STEEL DIN 917         | 4   | PZ         |                     |  |      |             |                             |     |          |   |                                    |   |          |                                      |  |    |          |  |                      |    |          |                                |                             |    |          |  |  |    |          |             |   |    |          |                 |                              |    |    |          |                    |   |    |          |   |    |    |          |                         |   |    |          |                            |   |    |
| VI1945A0  | ENG-VITE<br>M4X20 TCB+<br>INOX                     | 4   | PZ         |                     |  |      |             |                             |     |          |   |                                    |   |          |                                      |  |    |          |  |                      |    |          |                                |                             |    |          |  |  |    |          |             |   |    |          |                 |                              |    |    |          |                    |   |    |          |   |    |    |          |                         |   |    |          |                            |   |    |
| VI1950A0  | ST. STEEL<br>4,2X13 TCB<br>SELF-DRILLIN<br>G SCREW | 2   | PZ         |                     |  |      |             |                             |     |          |   |                                    |   |          |                                      |  |    |          |  |                      |    |          |                                |                             |    |          |  |  |    |          |             |   |    |          |                 |                              |    |    |          |                    |   |    |          |   |    |    |          |                         |   |    |          |                            |   |    |
| VL1005A1  | U-TRAP TANK  | 1   | PZ         |                     |  |      |             |                             |     |          |   |                                    |   |          |                                      |  |    |          |  |                      |    |          |                                |                             |    |          |  |  |    |          |             |   |    |          |                 |                              |    |    |          |                    |   |    |          |   |    |    |          |                         |   |    |          |                            |   |    |
| VL1006A0  | SYPHON<br>COVER                                    | 1   | PZ         |                     |  |      |             |                             |     |          |   |                                    |   |          |                                      |  |    |          |  |                      |    |          |                                |                             |    |          |  |  |    |          |             |   |    |          |                 |                              |    |    |          |                    |   |    |          |   |    |    |          |                         |   |    |          |                            |   |    |
| XC653     | LINEMISSTOP XFT140 STACKING KIT                    | <table border="1"> <thead> <tr> <th>Code</th> <th>Description</th> <th>Qty</th> <th>UOM</th> </tr> </thead> <tbody> <tr> <td>0H1237A0</td> <td>LM TOP<br/>SIPHON<br/>SUPPORT</td> <td>2</td> <td>PZ</td> </tr> <tr> <td>0H7084A0</td> <td>XC651 FRONT<br/>STACKING<br/>PROFILE</td> <td>1</td> <td>PZ</td> </tr> <tr> <td>0H7085A0</td> <td>LM 600 XC<br/>STACKING KIT<br/>BACK PROFIL</td> <td>2</td> <td>PZ</td> </tr> <tr> <td>ED1246A0</td> <td>HOT SURFACE<br/>LABEL</td> <td>1</td> <td>PZ</td> </tr> <tr> <td>ED1271A0</td> <td>LIQUID FALLS<br/>DANGER LABE</td> <td>1</td> <td>PZ</td> </tr> <tr> <td>EL1020A1</td> <td>D8<br/>INTERMEDIAT<br/>E T-SHAPED<br/>FITTING</td> <td>2</td> <td>PZ</td> </tr> <tr> <td>EL1180A0</td> <td>Ø8-Ø8<br/>FEMALE<br/>NON-RETURN<br/>CONNECTION</td> <td>2</td> <td>PZ</td> </tr> <tr> <td>GN1508A0</td> <td>O-RING<br/>GASKET COD<br/>2400</td> <td>2</td> <td>PZ</td> </tr> <tr> <td>RC1008A0</td> <td>D9 ELASTIC<br/>CLIP</td> <td>7</td> <td>PZ</td> </tr> <tr> <td>RC1055A0</td> <td>Ø25-40 H12<br/>STAINLESS<br/>STEEL PIPE<br/>CLIP</td> <td>10</td> <td>PZ</td> </tr> <tr> <td>RC1297A1</td> <td>D10 T-SHAPED<br/>FITTING</td> <td>1</td> <td>PZ</td> </tr> <tr> <td>RC1360A0</td> <td>10 - 10 JG<br/>ELBOW FITTIN</td> <td>1</td> <td>PZ</td> </tr> </tbody> </table> | Code       | Description         | Qty  | UOM  | 0H1237A0    | LM TOP<br>SIPHON<br>SUPPORT | 2   | PZ       | 0H7084A0  | XC651 FRONT<br>STACKING<br>PROFILE | 1 | PZ       | 0H7085A0                             | LM 600 XC<br>STACKING KIT<br>BACK PROFIL | 2  | PZ       | ED1246A0                                   | HOT SURFACE<br>LABEL | 1  | PZ       | ED1271A0                       | LIQUID FALLS<br>DANGER LABE | 1  | PZ       | EL1020A1   | D8<br>INTERMEDIAT<br>E T-SHAPED<br>FITTING | 2  | PZ       | EL1180A0    | Ø8-Ø8<br>FEMALE<br>NON-RETURN<br>CONNECTION | 2  | PZ       | GN1508A0        | O-RING<br>GASKET COD<br>2400 | 2  | PZ | RC1008A0 | D9 ELASTIC<br>CLIP | 7 | PZ | RC1055A0 | Ø25-40 H12<br>STAINLESS<br>STEEL PIPE<br>CLIP | 10 | PZ | RC1297A1 | D10 T-SHAPED<br>FITTING | 1 | PZ | RC1360A0 | 10 - 10 JG<br>ELBOW FITTIN | 1 | PZ |
| Code      | Description  | Qty   | UOM        |                     |  |      |             |                             |     |          |   |                                    |   |          |                                      |  |    |          |  |                      |    |          |                                |                             |    |          |  |  |    |          |             |   |    |          |                 |                              |    |    |          |                    |   |    |          |   |    |    |          |                         |   |    |          |                            |   |    |
| 0H1237A0  | LM TOP<br>SIPHON<br>SUPPORT                        | 2   | PZ         |                     |  |      |             |                             |     |          |   |                                    |   |          |                                      |  |    |          |  |                      |    |          |                                |                             |    |          |  |  |    |          |             |   |    |          |                 |                              |    |    |          |                    |   |    |          |   |    |    |          |                         |   |    |          |                            |   |    |
| 0H7084A0  | XC651 FRONT<br>STACKING<br>PROFILE                 | 1   | PZ         |                     |  |      |             |                             |     |          |   |                                    |   |          |                                      |  |    |          |  |                      |    |          |                                |                             |    |          |  |  |    |          |             |   |    |          |                 |                              |    |    |          |                    |   |    |          |   |    |    |          |                         |   |    |          |                            |   |    |
| 0H7085A0  | LM 600 XC<br>STACKING KIT<br>BACK PROFIL           | 2   | PZ         |                     |  |      |             |                             |     |          |   |                                    |   |          |                                      |  |    |          |  |                      |    |          |                                |                             |    |          |  |  |    |          |             |   |    |          |                 |                              |    |    |          |                    |   |    |          |   |    |    |          |                         |   |    |          |                            |   |    |
| ED1246A0  | HOT SURFACE<br>LABEL                               | 1   | PZ         |                     |  |      |             |                             |     |          |   |                                    |   |          |                                      |  |    |          |  |                      |    |          |                                |                             |    |          |  |  |    |          |             |   |    |          |                 |                              |    |    |          |                    |   |    |          |   |    |    |          |                         |   |    |          |                            |   |    |
| ED1271A0  | LIQUID FALLS<br>DANGER LABE                        | 1   | PZ         |                     |  |      |             |                             |     |          |   |                                    |   |          |                                      |  |    |          |  |                      |    |          |                                |                             |    |          |  |  |    |          |             |   |    |          |                 |                              |    |    |          |                    |   |    |          |   |    |    |          |                         |   |    |          |                            |   |    |
| EL1020A1  | D8<br>INTERMEDIAT<br>E T-SHAPED<br>FITTING         | 2   | PZ         |                     |  |      |             |                             |     |          |   |                                    |   |          |                                      |  |    |          |  |                      |    |          |                                |                             |    |          |  |  |    |          |             |   |    |          |                 |                              |    |    |          |                    |   |    |          |   |    |    |          |                         |   |    |          |                            |   |    |
| EL1180A0  | Ø8-Ø8<br>FEMALE<br>NON-RETURN<br>CONNECTION        | 2   | PZ         |                     |  |      |             |                             |     |          |   |                                    |   |          |                                      |  |    |          |  |                      |    |          |                                |                             |    |          |  |  |    |          |             |   |    |          |                 |                              |    |    |          |                    |   |    |          |   |    |    |          |                         |   |    |          |                            |   |    |
| GN1508A0  | O-RING<br>GASKET COD<br>2400                       | 2   | PZ         |                     |  |      |             |                             |     |          |   |                                    |   |          |                                      |  |    |          |  |                      |    |          |                                |                             |    |          |  |  |    |          |             |   |    |          |                 |                              |    |    |          |                    |   |    |          |   |    |    |          |                         |   |    |          |                            |   |    |
| RC1008A0  | D9 ELASTIC<br>CLIP                                 | 7   | PZ         |                     |  |      |             |                             |     |          |   |                                    |   |          |                                      |  |    |          |  |                      |    |          |                                |                             |    |          |  |  |    |          |             |   |    |          |                 |                              |    |    |          |                    |   |    |          |   |    |    |          |                         |   |    |          |                            |   |    |
| RC1055A0  | Ø25-40 H12<br>STAINLESS<br>STEEL PIPE<br>CLIP      | 10  | PZ         |                     |  |      |             |                             |     |          |   |                                    |   |          |                                      |  |    |          |  |                      |    |          |                                |                             |    |          |  |  |    |          |             |   |    |          |                 |                              |    |    |          |                    |   |    |          |   |    |    |          |                         |   |    |          |                            |   |    |
| RC1297A1  | D10 T-SHAPED<br>FITTING                            | 1   | PZ         |                     |  |      |             |                             |     |          |   |                                    |   |          |                                      |  |    |          |  |                      |    |          |                                |                             |    |          |  |  |    |          |             |   |    |          |                 |                              |    |    |          |                    |   |    |          |   |    |    |          |                         |   |    |          |                            |   |    |
| RC1360A0  | 10 - 10 JG<br>ELBOW FITTIN                         | 1   | PZ         |                     |  |      |             |                             |     |          |   |                                    |   |          |                                      |  |    |          |  |                      |    |          |                                |                             |    |          |  |  |    |          |             |   |    |          |                 |                              |    |    |          |                    |   |    |          |   |    |    |          |                         |   |    |          |                            |   |    |



| COMPONENT |  |   | SPARE PART |                                       |   |      |             |     |     |          |              |   |    |          |                                       |   |    |          |   |       |   |          |   |   |   |          |              |       |   |          |                                      |    |    |          |  |   |    |          |                                |   |    |          |  |    |    |          |             |   |    |          |                 |   |    |          |   |   |    |          |   |   |    |          |   |   |    |          |                             |   |    |          |                       |   |    |       |  |  |      |             |     |     |          |                                    |   |    |          |                             |   |    |          |                                  |   |    |
|-----------|--|---|------------|---------------------------------------|---|------|-------------|-----|-----|----------|--------------|---|----|----------|---------------------------------------|---|----|----------|---|-------|---|----------|---|---|---|----------|--------------|-------|---|----------|--------------------------------------|----|----|----------|--|---|----|----------|--------------------------------|---|----|----------|--|----|----|----------|-------------|---|----|----------|-----------------|---|----|----------|---|---|----|----------|---|---|----|----------|---|---|----|----------|-----------------------------|---|----|----------|-----------------------|---|----|-------|--|--|------|-------------|-----|-----|----------|------------------------------------|---|----|----------|-----------------------------|---|----|----------|----------------------------------|---|----|
| Code      | Description  | Image   | Code       | Description                           | Components list   |      |             |     |     |          |              |   |    |          |                                       |   |    |          |   |       |   |          |   |   |   |          |              |       |   |          |                                      |    |    |          |  |   |    |          |                                |   |    |          |  |    |    |          |             |   |    |          |                 |   |    |          |   |   |    |          |   |   |    |          |   |   |    |          |                             |   |    |          |                       |   |    |       |  |  |      |             |     |     |          |                                    |   |    |          |                             |   |    |          |                                  |   |    |
| VL1006A   | SYPHON COVER                                       |  | XC653      | LINEMISSTOP<br>XFT140 STACKING<br>KIT | <table border="1"> <thead> <tr> <th>Code</th> <th>Description</th> <th>Qty</th> <th>UOM</th> </tr> </thead> <tbody> <tr> <td>RC1376A0</td> <td>Ø6 Y-FITTING</td> <td>1</td> <td>PZ</td> </tr> <tr> <td>TB1177A0</td> <td>FOOT PANEL<br/>40X40 H58<br/>OVERLAP LM</td> <td>4</td> <td>PZ</td> </tr> <tr> <td>TB1520A0</td> <td>INT. Ø=38<br/>TH=4 DRAIN<br/>BLACK<br/>RUBBER PIPE</td> <td>2.700</td> <td>M</td> </tr> <tr> <td>TB1815A0</td> <td>7,93X4,75 PE<br/>TRANSP. PIPE<br/>(JG<br/>#PE08100N)</td> <td>2</td> <td>M</td> </tr> <tr> <td>TB2243A0</td> <td>Ø10 PET PIPE</td> <td>1.500</td> <td>M</td> </tr> <tr> <td>VI1220A1</td> <td>4,2X12 TCB<br/>SELF-TAPPIN<br/>G SCREW</td> <td>16</td> <td>PZ</td> </tr> <tr> <td>VI1895A0</td> <td>BLIND NUT M4<br/>STAINLESS<br/>STEEL DIN 917</td> <td>8</td> <td>PZ</td> </tr> <tr> <td>VI1945A0</td> <td>ENG-VITE<br/>M4X20 TCB+<br/>INOX</td> <td>8</td> <td>PZ</td> </tr> <tr> <td>VI1950A0</td> <td>ST. STEEL<br/>4,2X13 TCB<br/>SELF-DRILLIN<br/>G SCREW</td> <td>10</td> <td>PZ</td> </tr> <tr> <td>VL1005A1</td> <td>U-TRAP TANK</td> <td>2</td> <td>PZ</td> </tr> <tr> <td>VL1006A0</td> <td>SYPHON<br/>COVER</td> <td>2</td> <td>PZ</td> </tr> <tr> <td>VL1046A1</td> <td>D6 PIPE<br/>HOLDER - D6<br/>J.G. TERMINAL</td> <td>6</td> <td>PZ</td> </tr> <tr> <td>VL1047A1</td> <td>D6 PIPE<br/>HOLDER - D6<br/>J.G. TERMINAL</td> <td>2</td> <td>PZ</td> </tr> <tr> <td>VM1015A1</td> <td>STAINLESS<br/>STEEL<br/>Ø30X1.5 90°<br/>BEND</td> <td>1</td> <td>PZ</td> </tr> <tr> <td>VM1794A0</td> <td>250X4.8 PA66<br/>BLACK CLAMP</td> <td>2</td> <td>PZ</td> </tr> <tr> <td>VM2035A0</td> <td>DRAIN PIPE<br/>SUPPORT</td> <td>1</td> <td>PZ</td> </tr> </tbody> </table> | Code | Description | Qty | UOM | RC1376A0 | Ø6 Y-FITTING | 1 | PZ | TB1177A0 | FOOT PANEL<br>40X40 H58<br>OVERLAP LM | 4 | PZ | TB1520A0 | INT. Ø=38<br>TH=4 DRAIN<br>BLACK<br>RUBBER PIPE | 2.700 | M | TB1815A0 | 7,93X4,75 PE<br>TRANSP. PIPE<br>(JG<br>#PE08100N) | 2 | M | TB2243A0 | Ø10 PET PIPE | 1.500 | M | VI1220A1 | 4,2X12 TCB<br>SELF-TAPPIN<br>G SCREW | 16 | PZ | VI1895A0 | BLIND NUT M4<br>STAINLESS<br>STEEL DIN 917 | 8 | PZ | VI1945A0 | ENG-VITE<br>M4X20 TCB+<br>INOX | 8 | PZ | VI1950A0 | ST. STEEL<br>4,2X13 TCB<br>SELF-DRILLIN<br>G SCREW | 10 | PZ | VL1005A1 | U-TRAP TANK | 2 | PZ | VL1006A0 | SYPHON<br>COVER | 2 | PZ | VL1046A1 | D6 PIPE<br>HOLDER - D6<br>J.G. TERMINAL | 6 | PZ | VL1047A1 | D6 PIPE<br>HOLDER - D6<br>J.G. TERMINAL | 2 | PZ | VM1015A1 | STAINLESS<br>STEEL<br>Ø30X1.5 90°<br>BEND | 1 | PZ | VM1794A0 | 250X4.8 PA66<br>BLACK CLAMP | 2 | PZ | VM2035A0 | DRAIN PIPE<br>SUPPORT | 1 | PZ | XC649 | LINEMISS TOP FULL<br>SIZE STACKING KIT | <table border="1"> <thead> <tr> <th>Code</th> <th>Description</th> <th>Qty</th> <th>UOM</th> </tr> </thead> <tbody> <tr> <td>0H1151A0</td> <td>PROOFER-OV<br/>EN FIXING<br/>BRACKET</td> <td>4</td> <td>PZ</td> </tr> <tr> <td>0H1237A0</td> <td>LM TOP<br/>SIPHON<br/>SUPPORT</td> <td>2</td> <td>PZ</td> </tr> <tr> <td>ED1335A0</td> <td>CAUTION HOT<br/>TRIANGLE<br/>LABEL</td> <td>1</td> <td>PZ</td> </tr> </tbody> </table> | Code | Description | Qty | UOM | 0H1151A0 | PROOFER-OV<br>EN FIXING<br>BRACKET | 4 | PZ | 0H1237A0 | LM TOP<br>SIPHON<br>SUPPORT | 2 | PZ | ED1335A0 | CAUTION HOT<br>TRIANGLE<br>LABEL | 1 | PZ |
|           |  |   | Code       | Description                           | Qty   | UOM  |             |     |     |          |              |   |    |          |                                       |   |    |          |   |       |   |          |   |   |   |          |              |       |   |          |                                      |    |    |          |  |   |    |          |                                |   |    |          |  |    |    |          |             |   |    |          |                 |   |    |          |   |   |    |          |   |   |    |          |   |   |    |          |                             |   |    |          |                       |   |    |       |  |  |      |             |     |     |          |                                    |   |    |          |                             |   |    |          |                                  |   |    |
| RC1376A0  | Ø6 Y-FITTING                                       | 1   | PZ         |                                       |   |      |             |     |     |          |              |   |    |          |                                       |   |    |          |   |       |   |          |   |   |   |          |              |       |   |          |                                      |    |    |          |  |   |    |          |                                |   |    |          |  |    |    |          |             |   |    |          |                 |   |    |          |   |   |    |          |   |   |    |          |   |   |    |          |                             |   |    |          |                       |   |    |       |  |  |      |             |     |     |          |                                    |   |    |          |                             |   |    |          |                                  |   |    |
| TB1177A0  | FOOT PANEL<br>40X40 H58<br>OVERLAP LM              | 4   | PZ         |                                       |   |      |             |     |     |          |              |   |    |          |                                       |   |    |          |   |       |   |          |   |   |   |          |              |       |   |          |                                      |    |    |          |  |   |    |          |                                |   |    |          |  |    |    |          |             |   |    |          |                 |   |    |          |   |   |    |          |   |   |    |          |   |   |    |          |                             |   |    |          |                       |   |    |       |  |  |      |             |     |     |          |                                    |   |    |          |                             |   |    |          |                                  |   |    |
| TB1520A0  | INT. Ø=38<br>TH=4 DRAIN<br>BLACK<br>RUBBER PIPE    | 2.700   | M          |                                       |   |      |             |     |     |          |              |   |    |          |                                       |   |    |          |   |       |   |          |   |   |   |          |              |       |   |          |                                      |    |    |          |  |   |    |          |                                |   |    |          |  |    |    |          |             |   |    |          |                 |   |    |          |   |   |    |          |   |   |    |          |   |   |    |          |                             |   |    |          |                       |   |    |       |  |  |      |             |     |     |          |                                    |   |    |          |                             |   |    |          |                                  |   |    |
| TB1815A0  | 7,93X4,75 PE<br>TRANSP. PIPE<br>(JG<br>#PE08100N)  | 2   | M          |                                       |   |      |             |     |     |          |              |   |    |          |                                       |   |    |          |   |       |   |          |   |   |   |          |              |       |   |          |                                      |    |    |          |  |   |    |          |                                |   |    |          |  |    |    |          |             |   |    |          |                 |   |    |          |   |   |    |          |   |   |    |          |   |   |    |          |                             |   |    |          |                       |   |    |       |  |  |      |             |     |     |          |                                    |   |    |          |                             |   |    |          |                                  |   |    |
| TB2243A0  | Ø10 PET PIPE                                       | 1.500   | M          |                                       |   |      |             |     |     |          |              |   |    |          |                                       |   |    |          |   |       |   |          |   |   |   |          |              |       |   |          |                                      |    |    |          |  |   |    |          |                                |   |    |          |  |    |    |          |             |   |    |          |                 |   |    |          |   |   |    |          |   |   |    |          |   |   |    |          |                             |   |    |          |                       |   |    |       |  |  |      |             |     |     |          |                                    |   |    |          |                             |   |    |          |                                  |   |    |
| VI1220A1  | 4,2X12 TCB<br>SELF-TAPPIN<br>G SCREW               | 16  | PZ         |                                       |   |      |             |     |     |          |              |   |    |          |                                       |   |    |          |   |       |   |          |   |   |   |          |              |       |   |          |                                      |    |    |          |  |   |    |          |                                |   |    |          |  |    |    |          |             |   |    |          |                 |   |    |          |   |   |    |          |   |   |    |          |   |   |    |          |                             |   |    |          |                       |   |    |       |  |  |      |             |     |     |          |                                    |   |    |          |                             |   |    |          |                                  |   |    |
| VI1895A0  | BLIND NUT M4<br>STAINLESS<br>STEEL DIN 917         | 8   | PZ         |                                       |   |      |             |     |     |          |              |   |    |          |                                       |   |    |          |   |       |   |          |   |   |   |          |              |       |   |          |                                      |    |    |          |  |   |    |          |                                |   |    |          |  |    |    |          |             |   |    |          |                 |   |    |          |   |   |    |          |   |   |    |          |   |   |    |          |                             |   |    |          |                       |   |    |       |  |  |      |             |     |     |          |                                    |   |    |          |                             |   |    |          |                                  |   |    |
| VI1945A0  | ENG-VITE<br>M4X20 TCB+<br>INOX                     | 8   | PZ         |                                       |   |      |             |     |     |          |              |   |    |          |                                       |   |    |          |   |       |   |          |   |   |   |          |              |       |   |          |                                      |    |    |          |  |   |    |          |                                |   |    |          |  |    |    |          |             |   |    |          |                 |   |    |          |   |   |    |          |   |   |    |          |   |   |    |          |                             |   |    |          |                       |   |    |       |  |  |      |             |     |     |          |                                    |   |    |          |                             |   |    |          |                                  |   |    |
| VI1950A0  | ST. STEEL<br>4,2X13 TCB<br>SELF-DRILLIN<br>G SCREW | 10  | PZ         |                                       |   |      |             |     |     |          |              |   |    |          |                                       |   |    |          |   |       |   |          |   |   |   |          |              |       |   |          |                                      |    |    |          |  |   |    |          |                                |   |    |          |  |    |    |          |             |   |    |          |                 |   |    |          |   |   |    |          |   |   |    |          |   |   |    |          |                             |   |    |          |                       |   |    |       |  |  |      |             |     |     |          |                                    |   |    |          |                             |   |    |          |                                  |   |    |
| VL1005A1  | U-TRAP TANK  | 2   | PZ         |                                       |   |      |             |     |     |          |              |   |    |          |                                       |   |    |          |   |       |   |          |   |   |   |          |              |       |   |          |                                      |    |    |          |  |   |    |          |                                |   |    |          |  |    |    |          |             |   |    |          |                 |   |    |          |   |   |    |          |   |   |    |          |   |   |    |          |                             |   |    |          |                       |   |    |       |  |  |      |             |     |     |          |                                    |   |    |          |                             |   |    |          |                                  |   |    |
| VL1006A0  | SYPHON<br>COVER                                    | 2   | PZ         |                                       |   |      |             |     |     |          |              |   |    |          |                                       |   |    |          |   |       |   |          |   |   |   |          |              |       |   |          |                                      |    |    |          |  |   |    |          |                                |   |    |          |  |    |    |          |             |   |    |          |                 |   |    |          |   |   |    |          |   |   |    |          |   |   |    |          |                             |   |    |          |                       |   |    |       |  |  |      |             |     |     |          |                                    |   |    |          |                             |   |    |          |                                  |   |    |
| VL1046A1  | D6 PIPE<br>HOLDER - D6<br>J.G. TERMINAL            | 6   | PZ         |                                       |   |      |             |     |     |          |              |   |    |          |                                       |   |    |          |   |       |   |          |   |   |   |          |              |       |   |          |                                      |    |    |          |  |   |    |          |                                |   |    |          |  |    |    |          |             |   |    |          |                 |   |    |          |   |   |    |          |   |   |    |          |   |   |    |          |                             |   |    |          |                       |   |    |       |  |  |      |             |     |     |          |                                    |   |    |          |                             |   |    |          |                                  |   |    |
| VL1047A1  | D6 PIPE<br>HOLDER - D6<br>J.G. TERMINAL            | 2   | PZ         |                                       |   |      |             |     |     |          |              |   |    |          |                                       |   |    |          |   |       |   |          |   |   |   |          |              |       |   |          |                                      |    |    |          |  |   |    |          |                                |   |    |          |  |    |    |          |             |   |    |          |                 |   |    |          |   |   |    |          |   |   |    |          |   |   |    |          |                             |   |    |          |                       |   |    |       |  |  |      |             |     |     |          |                                    |   |    |          |                             |   |    |          |                                  |   |    |
| VM1015A1  | STAINLESS<br>STEEL<br>Ø30X1.5 90°<br>BEND          | 1   | PZ         |                                       |   |      |             |     |     |          |              |   |    |          |                                       |   |    |          |   |       |   |          |   |   |   |          |              |       |   |          |                                      |    |    |          |  |   |    |          |                                |   |    |          |  |    |    |          |             |   |    |          |                 |   |    |          |   |   |    |          |   |   |    |          |   |   |    |          |                             |   |    |          |                       |   |    |       |  |  |      |             |     |     |          |                                    |   |    |          |                             |   |    |          |                                  |   |    |
| VM1794A0  | 250X4.8 PA66<br>BLACK CLAMP                        | 2   | PZ         |                                       |   |      |             |     |     |          |              |   |    |          |                                       |   |    |          |   |       |   |          |   |   |   |          |              |       |   |          |                                      |    |    |          |  |   |    |          |                                |   |    |          |  |    |    |          |             |   |    |          |                 |   |    |          |   |   |    |          |   |   |    |          |   |   |    |          |                             |   |    |          |                       |   |    |       |  |  |      |             |     |     |          |                                    |   |    |          |                             |   |    |          |                                  |   |    |
| VM2035A0  | DRAIN PIPE<br>SUPPORT                              | 1   | PZ         |                                       |   |      |             |     |     |          |              |   |    |          |                                       |   |    |          |   |       |   |          |   |   |   |          |              |       |   |          |                                      |    |    |          |  |   |    |          |                                |   |    |          |  |    |    |          |             |   |    |          |                 |   |    |          |   |   |    |          |   |   |    |          |   |   |    |          |                             |   |    |          |                       |   |    |       |  |  |      |             |     |     |          |                                    |   |    |          |                             |   |    |          |                                  |   |    |
| Code      | Description  | Qty   | UOM        |                                       |   |      |             |     |     |          |              |   |    |          |                                       |   |    |          |   |       |   |          |   |   |   |          |              |       |   |          |                                      |    |    |          |  |   |    |          |                                |   |    |          |  |    |    |          |             |   |    |          |                 |   |    |          |   |   |    |          |   |   |    |          |   |   |    |          |                             |   |    |          |                       |   |    |       |  |  |      |             |     |     |          |                                    |   |    |          |                             |   |    |          |                                  |   |    |
| 0H1151A0  | PROOFER-OV<br>EN FIXING<br>BRACKET                 | 4   | PZ         |                                       |   |      |             |     |     |          |              |   |    |          |                                       |   |    |          |   |       |   |          |   |   |   |          |              |       |   |          |                                      |    |    |          |  |   |    |          |                                |   |    |          |  |    |    |          |             |   |    |          |                 |   |    |          |   |   |    |          |   |   |    |          |   |   |    |          |                             |   |    |          |                       |   |    |       |  |  |      |             |     |     |          |                                    |   |    |          |                             |   |    |          |                                  |   |    |
| 0H1237A0  | LM TOP<br>SIPHON<br>SUPPORT                        | 2   | PZ         |                                       |   |      |             |     |     |          |              |   |    |          |                                       |   |    |          |   |       |   |          |   |   |   |          |              |       |   |          |                                      |    |    |          |  |   |    |          |                                |   |    |          |  |    |    |          |             |   |    |          |                 |   |    |          |   |   |    |          |   |   |    |          |   |   |    |          |                             |   |    |          |                       |   |    |       |  |  |      |             |     |     |          |                                    |   |    |          |                             |   |    |          |                                  |   |    |
| ED1335A0  | CAUTION HOT<br>TRIANGLE<br>LABEL                   | 1   | PZ         |                                       |   |      |             |     |     |          |              |   |    |          |                                       |   |    |          |   |       |   |          |   |   |   |          |              |       |   |          |                                      |    |    |          |  |   |    |          |                                |   |    |          |  |    |    |          |             |   |    |          |                 |   |    |          |   |   |    |          |   |   |    |          |   |   |    |          |                             |   |    |          |                       |   |    |       |  |  |      |             |     |     |          |                                    |   |    |          |                             |   |    |          |                                  |   |    |



| COMPONENT |   |   | SPARE PART |                                     |   |      |             |     |     |          |                             |   |    |          |                                   |   |    |          |                            |   |    |          |                        |   |    |          |                 |   |    |          |                                      |   |    |          |                      |   |    |          |                         |   |    |          |              |   |    |          |  |       |   |          |  |   |   |          |              |       |   |          |                                |   |    |          |                                      |   |    |          |                          |   |    |          |   |   |    |          |             |   |    |          |              |   |    |          |                                   |   |    |          |                          |   |    |          |                    |   |    |
|-----------|---|---|------------|-------------------------------------|---|------|-------------|-----|-----|----------|-----------------------------|---|----|----------|-----------------------------------|---|----|----------|----------------------------|---|----|----------|------------------------|---|----|----------|-----------------|---|----|----------|--------------------------------------|---|----|----------|----------------------|---|----|----------|-------------------------|---|----|----------|--------------|---|----|----------|--|-------|---|----------|--|---|---|----------|--------------|-------|---|----------|--------------------------------|---|----|----------|--------------------------------------|---|----|----------|--------------------------|---|----|----------|---|---|----|----------|-------------|---|----|----------|--------------|---|----|----------|-----------------------------------|---|----|----------|--------------------------|---|----|----------|--------------------|---|----|
| Code      | Description                               | Image   | Code       | Description                         | Components list   |      |             |     |     |          |                             |   |    |          |                                   |   |    |          |                            |   |    |          |                        |   |    |          |                 |   |    |          |                                      |   |    |          |                      |   |    |          |                         |   |    |          |              |   |    |          |  |       |   |          |  |   |   |          |              |       |   |          |                                |   |    |          |                                      |   |    |          |                          |   |    |          |   |   |    |          |             |   |    |          |              |   |    |          |                                   |   |    |          |                          |   |    |          |                    |   |    |
| VL1006A   | SYPHON COVER                              |  | XC649      | LINEMISS TOP FULL SIZE STACKING KIT | <table border="1"> <thead> <tr> <th>Code</th> <th>Description</th> <th>Qty</th> <th>UOM</th> </tr> </thead> <tbody> <tr> <td>ED1338A0</td> <td>UL LIQUID FALLS DANGER LABE</td> <td>1</td> <td>PZ</td> </tr> <tr> <td>EL1020A1</td> <td>D8 INTERMEDIAT E T-SHAPED FITTING</td> <td>2</td> <td>PZ</td> </tr> <tr> <td>EL1185A0</td> <td>Ø8F - Ø8F ELBOW CONNECTION</td> <td>2</td> <td>PZ</td> </tr> <tr> <td>GN1508A0</td> <td>O-RING GASKET COD 2400</td> <td>2</td> <td>PZ</td> </tr> <tr> <td>RC1008A0</td> <td>D9 ELASTIC CLIP</td> <td>3</td> <td>PZ</td> </tr> <tr> <td>RC1055A0</td> <td>Ø25-40 H12 STAINLESS STEEL PIPE CLIP</td> <td>8</td> <td>PZ</td> </tr> <tr> <td>RC1297A1</td> <td>D10 T-SHAPED FITTING</td> <td>1</td> <td>PZ</td> </tr> <tr> <td>RC1360A0</td> <td>10 - 10 JG ELBOW FITTIN</td> <td>1</td> <td>PZ</td> </tr> <tr> <td>RC1376A0</td> <td>Ø6 Y-FITTING</td> <td>1</td> <td>PZ</td> </tr> <tr> <td>TB1520A0</td> <td>INT. Ø=38 TH=4 DRAIN BLACK RUBBER PIPE</td> <td>2.840</td> <td>M</td> </tr> <tr> <td>TB1815A0</td> <td>7,93X4,75 PE TRANSP. PIPE (JG #PE08100N)</td> <td>2</td> <td>M</td> </tr> <tr> <td>TB2243A0</td> <td>Ø10 PET PIPE</td> <td>1.500</td> <td>M</td> </tr> <tr> <td>VI1220A1</td> <td>4,2X12 TCB SELF-TAPPIN G SCREW</td> <td>7</td> <td>PZ</td> </tr> <tr> <td>VI1895A0</td> <td>BLIND NUT M4 STAINLESS STEEL DIN 917</td> <td>8</td> <td>PZ</td> </tr> <tr> <td>VI1945A0</td> <td>ENG-VITE M4X20 TCB+ INOX</td> <td>8</td> <td>PZ</td> </tr> <tr> <td>VI1950A0</td> <td>ST. STEEL 4,2X13 TCB SELF-DRILLIN G SCREW</td> <td>6</td> <td>PZ</td> </tr> <tr> <td>VL1005A1</td> <td>U-TRAP TANK</td> <td>2</td> <td>PZ</td> </tr> <tr> <td>VL1006A0</td> <td>SYPHON COVER</td> <td>2</td> <td>PZ</td> </tr> <tr> <td>VL1046A1</td> <td>D6 PIPE HOLDER - D6 J.G. TERMINAL</td> <td>3</td> <td>PZ</td> </tr> <tr> <td>VM1794A0</td> <td>250X4.8 PA66 BLACK CLAMP</td> <td>2</td> <td>PZ</td> </tr> <tr> <td>VM2035A0</td> <td>DRAIN PIPE SUPPORT</td> <td>1</td> <td>PZ</td> </tr> </tbody> </table> | Code | Description | Qty | UOM | ED1338A0 | UL LIQUID FALLS DANGER LABE | 1 | PZ | EL1020A1 | D8 INTERMEDIAT E T-SHAPED FITTING | 2 | PZ | EL1185A0 | Ø8F - Ø8F ELBOW CONNECTION | 2 | PZ | GN1508A0 | O-RING GASKET COD 2400 | 2 | PZ | RC1008A0 | D9 ELASTIC CLIP | 3 | PZ | RC1055A0 | Ø25-40 H12 STAINLESS STEEL PIPE CLIP | 8 | PZ | RC1297A1 | D10 T-SHAPED FITTING | 1 | PZ | RC1360A0 | 10 - 10 JG ELBOW FITTIN | 1 | PZ | RC1376A0 | Ø6 Y-FITTING | 1 | PZ | TB1520A0 | INT. Ø=38 TH=4 DRAIN BLACK RUBBER PIPE | 2.840 | M | TB1815A0 | 7,93X4,75 PE TRANSP. PIPE (JG #PE08100N) | 2 | M | TB2243A0 | Ø10 PET PIPE | 1.500 | M | VI1220A1 | 4,2X12 TCB SELF-TAPPIN G SCREW | 7 | PZ | VI1895A0 | BLIND NUT M4 STAINLESS STEEL DIN 917 | 8 | PZ | VI1945A0 | ENG-VITE M4X20 TCB+ INOX | 8 | PZ | VI1950A0 | ST. STEEL 4,2X13 TCB SELF-DRILLIN G SCREW | 6 | PZ | VL1005A1 | U-TRAP TANK | 2 | PZ | VL1006A0 | SYPHON COVER | 2 | PZ | VL1046A1 | D6 PIPE HOLDER - D6 J.G. TERMINAL | 3 | PZ | VM1794A0 | 250X4.8 PA66 BLACK CLAMP | 2 | PZ | VM2035A0 | DRAIN PIPE SUPPORT | 1 | PZ |
| Code      | Description                               | Qty   | UOM        |                                     |   |      |             |     |     |          |                             |   |    |          |                                   |   |    |          |                            |   |    |          |                        |   |    |          |                 |   |    |          |                                      |   |    |          |                      |   |    |          |                         |   |    |          |              |   |    |          |  |       |   |          |  |   |   |          |              |       |   |          |                                |   |    |          |                                      |   |    |          |                          |   |    |          |   |   |    |          |             |   |    |          |              |   |    |          |                                   |   |    |          |                          |   |    |          |                    |   |    |
| ED1338A0  | UL LIQUID FALLS DANGER LABE               | 1   | PZ         |                                     |   |      |             |     |     |          |                             |   |    |          |                                   |   |    |          |                            |   |    |          |                        |   |    |          |                 |   |    |          |                                      |   |    |          |                      |   |    |          |                         |   |    |          |              |   |    |          |  |       |   |          |  |   |   |          |              |       |   |          |                                |   |    |          |                                      |   |    |          |                          |   |    |          |   |   |    |          |             |   |    |          |              |   |    |          |                                   |   |    |          |                          |   |    |          |                    |   |    |
| EL1020A1  | D8 INTERMEDIAT E T-SHAPED FITTING         | 2   | PZ         |                                     |   |      |             |     |     |          |                             |   |    |          |                                   |   |    |          |                            |   |    |          |                        |   |    |          |                 |   |    |          |                                      |   |    |          |                      |   |    |          |                         |   |    |          |              |   |    |          |  |       |   |          |  |   |   |          |              |       |   |          |                                |   |    |          |                                      |   |    |          |                          |   |    |          |   |   |    |          |             |   |    |          |              |   |    |          |                                   |   |    |          |                          |   |    |          |                    |   |    |
| EL1185A0  | Ø8F - Ø8F ELBOW CONNECTION                | 2   | PZ         |                                     |   |      |             |     |     |          |                             |   |    |          |                                   |   |    |          |                            |   |    |          |                        |   |    |          |                 |   |    |          |                                      |   |    |          |                      |   |    |          |                         |   |    |          |              |   |    |          |  |       |   |          |  |   |   |          |              |       |   |          |                                |   |    |          |                                      |   |    |          |                          |   |    |          |   |   |    |          |             |   |    |          |              |   |    |          |                                   |   |    |          |                          |   |    |          |                    |   |    |
| GN1508A0  | O-RING GASKET COD 2400                    | 2   | PZ         |                                     |   |      |             |     |     |          |                             |   |    |          |                                   |   |    |          |                            |   |    |          |                        |   |    |          |                 |   |    |          |                                      |   |    |          |                      |   |    |          |                         |   |    |          |              |   |    |          |  |       |   |          |  |   |   |          |              |       |   |          |                                |   |    |          |                                      |   |    |          |                          |   |    |          |   |   |    |          |             |   |    |          |              |   |    |          |                                   |   |    |          |                          |   |    |          |                    |   |    |
| RC1008A0  | D9 ELASTIC CLIP                           | 3   | PZ         |                                     |   |      |             |     |     |          |                             |   |    |          |                                   |   |    |          |                            |   |    |          |                        |   |    |          |                 |   |    |          |                                      |   |    |          |                      |   |    |          |                         |   |    |          |              |   |    |          |  |       |   |          |  |   |   |          |              |       |   |          |                                |   |    |          |                                      |   |    |          |                          |   |    |          |   |   |    |          |             |   |    |          |              |   |    |          |                                   |   |    |          |                          |   |    |          |                    |   |    |
| RC1055A0  | Ø25-40 H12 STAINLESS STEEL PIPE CLIP      | 8   | PZ         |                                     |   |      |             |     |     |          |                             |   |    |          |                                   |   |    |          |                            |   |    |          |                        |   |    |          |                 |   |    |          |                                      |   |    |          |                      |   |    |          |                         |   |    |          |              |   |    |          |  |       |   |          |  |   |   |          |              |       |   |          |                                |   |    |          |                                      |   |    |          |                          |   |    |          |   |   |    |          |             |   |    |          |              |   |    |          |                                   |   |    |          |                          |   |    |          |                    |   |    |
| RC1297A1  | D10 T-SHAPED FITTING                      | 1   | PZ         |                                     |   |      |             |     |     |          |                             |   |    |          |                                   |   |    |          |                            |   |    |          |                        |   |    |          |                 |   |    |          |                                      |   |    |          |                      |   |    |          |                         |   |    |          |              |   |    |          |  |       |   |          |  |   |   |          |              |       |   |          |                                |   |    |          |                                      |   |    |          |                          |   |    |          |   |   |    |          |             |   |    |          |              |   |    |          |                                   |   |    |          |                          |   |    |          |                    |   |    |
| RC1360A0  | 10 - 10 JG ELBOW FITTIN                   | 1   | PZ         |                                     |   |      |             |     |     |          |                             |   |    |          |                                   |   |    |          |                            |   |    |          |                        |   |    |          |                 |   |    |          |                                      |   |    |          |                      |   |    |          |                         |   |    |          |              |   |    |          |  |       |   |          |  |   |   |          |              |       |   |          |                                |   |    |          |                                      |   |    |          |                          |   |    |          |   |   |    |          |             |   |    |          |              |   |    |          |                                   |   |    |          |                          |   |    |          |                    |   |    |
| RC1376A0  | Ø6 Y-FITTING                              | 1   | PZ         |                                     |   |      |             |     |     |          |                             |   |    |          |                                   |   |    |          |                            |   |    |          |                        |   |    |          |                 |   |    |          |                                      |   |    |          |                      |   |    |          |                         |   |    |          |              |   |    |          |  |       |   |          |  |   |   |          |              |       |   |          |                                |   |    |          |                                      |   |    |          |                          |   |    |          |   |   |    |          |             |   |    |          |              |   |    |          |                                   |   |    |          |                          |   |    |          |                    |   |    |
| TB1520A0  | INT. Ø=38 TH=4 DRAIN BLACK RUBBER PIPE    | 2.840   | M          |                                     |   |      |             |     |     |          |                             |   |    |          |                                   |   |    |          |                            |   |    |          |                        |   |    |          |                 |   |    |          |                                      |   |    |          |                      |   |    |          |                         |   |    |          |              |   |    |          |  |       |   |          |  |   |   |          |              |       |   |          |                                |   |    |          |                                      |   |    |          |                          |   |    |          |   |   |    |          |             |   |    |          |              |   |    |          |                                   |   |    |          |                          |   |    |          |                    |   |    |
| TB1815A0  | 7,93X4,75 PE TRANSP. PIPE (JG #PE08100N)  | 2   | M          |                                     |   |      |             |     |     |          |                             |   |    |          |                                   |   |    |          |                            |   |    |          |                        |   |    |          |                 |   |    |          |                                      |   |    |          |                      |   |    |          |                         |   |    |          |              |   |    |          |  |       |   |          |  |   |   |          |              |       |   |          |                                |   |    |          |                                      |   |    |          |                          |   |    |          |   |   |    |          |             |   |    |          |              |   |    |          |                                   |   |    |          |                          |   |    |          |                    |   |    |
| TB2243A0  | Ø10 PET PIPE                              | 1.500   | M          |                                     |   |      |             |     |     |          |                             |   |    |          |                                   |   |    |          |                            |   |    |          |                        |   |    |          |                 |   |    |          |                                      |   |    |          |                      |   |    |          |                         |   |    |          |              |   |    |          |  |       |   |          |  |   |   |          |              |       |   |          |                                |   |    |          |                                      |   |    |          |                          |   |    |          |   |   |    |          |             |   |    |          |              |   |    |          |                                   |   |    |          |                          |   |    |          |                    |   |    |
| VI1220A1  | 4,2X12 TCB SELF-TAPPIN G SCREW            | 7   | PZ         |                                     |   |      |             |     |     |          |                             |   |    |          |                                   |   |    |          |                            |   |    |          |                        |   |    |          |                 |   |    |          |                                      |   |    |          |                      |   |    |          |                         |   |    |          |              |   |    |          |  |       |   |          |  |   |   |          |              |       |   |          |                                |   |    |          |                                      |   |    |          |                          |   |    |          |   |   |    |          |             |   |    |          |              |   |    |          |                                   |   |    |          |                          |   |    |          |                    |   |    |
| VI1895A0  | BLIND NUT M4 STAINLESS STEEL DIN 917      | 8   | PZ         |                                     |   |      |             |     |     |          |                             |   |    |          |                                   |   |    |          |                            |   |    |          |                        |   |    |          |                 |   |    |          |                                      |   |    |          |                      |   |    |          |                         |   |    |          |              |   |    |          |  |       |   |          |  |   |   |          |              |       |   |          |                                |   |    |          |                                      |   |    |          |                          |   |    |          |   |   |    |          |             |   |    |          |              |   |    |          |                                   |   |    |          |                          |   |    |          |                    |   |    |
| VI1945A0  | ENG-VITE M4X20 TCB+ INOX                  | 8   | PZ         |                                     |   |      |             |     |     |          |                             |   |    |          |                                   |   |    |          |                            |   |    |          |                        |   |    |          |                 |   |    |          |                                      |   |    |          |                      |   |    |          |                         |   |    |          |              |   |    |          |  |       |   |          |  |   |   |          |              |       |   |          |                                |   |    |          |                                      |   |    |          |                          |   |    |          |   |   |    |          |             |   |    |          |              |   |    |          |                                   |   |    |          |                          |   |    |          |                    |   |    |
| VI1950A0  | ST. STEEL 4,2X13 TCB SELF-DRILLIN G SCREW | 6   | PZ         |                                     |   |      |             |     |     |          |                             |   |    |          |                                   |   |    |          |                            |   |    |          |                        |   |    |          |                 |   |    |          |                                      |   |    |          |                      |   |    |          |                         |   |    |          |              |   |    |          |  |       |   |          |  |   |   |          |              |       |   |          |                                |   |    |          |                                      |   |    |          |                          |   |    |          |   |   |    |          |             |   |    |          |              |   |    |          |                                   |   |    |          |                          |   |    |          |                    |   |    |
| VL1005A1  | U-TRAP TANK                               | 2   | PZ         |                                     |   |      |             |     |     |          |                             |   |    |          |                                   |   |    |          |                            |   |    |          |                        |   |    |          |                 |   |    |          |                                      |   |    |          |                      |   |    |          |                         |   |    |          |              |   |    |          |  |       |   |          |  |   |   |          |              |       |   |          |                                |   |    |          |                                      |   |    |          |                          |   |    |          |   |   |    |          |             |   |    |          |              |   |    |          |                                   |   |    |          |                          |   |    |          |                    |   |    |
| VL1006A0  | SYPHON COVER                              | 2   | PZ         |                                     |   |      |             |     |     |          |                             |   |    |          |                                   |   |    |          |                            |   |    |          |                        |   |    |          |                 |   |    |          |                                      |   |    |          |                      |   |    |          |                         |   |    |          |              |   |    |          |  |       |   |          |  |   |   |          |              |       |   |          |                                |   |    |          |                                      |   |    |          |                          |   |    |          |   |   |    |          |             |   |    |          |              |   |    |          |                                   |   |    |          |                          |   |    |          |                    |   |    |
| VL1046A1  | D6 PIPE HOLDER - D6 J.G. TERMINAL         | 3   | PZ         |                                     |   |      |             |     |     |          |                             |   |    |          |                                   |   |    |          |                            |   |    |          |                        |   |    |          |                 |   |    |          |                                      |   |    |          |                      |   |    |          |                         |   |    |          |              |   |    |          |  |       |   |          |  |   |   |          |              |       |   |          |                                |   |    |          |                                      |   |    |          |                          |   |    |          |   |   |    |          |             |   |    |          |              |   |    |          |                                   |   |    |          |                          |   |    |          |                    |   |    |
| VM1794A0  | 250X4.8 PA66 BLACK CLAMP                  | 2   | PZ         |                                     |   |      |             |     |     |          |                             |   |    |          |                                   |   |    |          |                            |   |    |          |                        |   |    |          |                 |   |    |          |                                      |   |    |          |                      |   |    |          |                         |   |    |          |              |   |    |          |  |       |   |          |  |   |   |          |              |       |   |          |                                |   |    |          |                                      |   |    |          |                          |   |    |          |   |   |    |          |             |   |    |          |              |   |    |          |                                   |   |    |          |                          |   |    |          |                    |   |    |
| VM2035A0  | DRAIN PIPE SUPPORT                        | 1   | PZ         |                                     |   |      |             |     |     |          |                             |   |    |          |                                   |   |    |          |                            |   |    |          |                        |   |    |          |                 |   |    |          |                                      |   |    |          |                      |   |    |          |                         |   |    |          |              |   |    |          |  |       |   |          |  |   |   |          |              |       |   |          |                                |   |    |          |                                      |   |    |          |                          |   |    |          |   |   |    |          |             |   |    |          |              |   |    |          |                                   |   |    |          |                          |   |    |          |                    |   |    |

| COMPONENT |   |   | SPARE PART |  |  |      |             |     |     |          |                             |   |    |          |   |   |    |          |  |   |    |          |                      |   |    |          |                             |   |    |          |  |   |    |          |   |   |    |          |                              |   |    |          |                    |   |    |          |   |    |    |          |                         |   |    |          |                            |   |    |          |              |   |    |          |                                       |   |    |          |   |       |   |          |   |   |   |          |              |       |   |          |                                      |    |    |          |  |   |    |
|-----------|---|---|------------|--|--|------|-------------|-----|-----|----------|-----------------------------|---|----|----------|---|---|----|----------|--|---|----|----------|----------------------|---|----|----------|-----------------------------|---|----|----------|--|---|----|----------|---|---|----|----------|------------------------------|---|----|----------|--------------------|---|----|----------|---|----|----|----------|-------------------------|---|----|----------|----------------------------|---|----|----------|--------------|---|----|----------|---------------------------------------|---|----|----------|---|-------|---|----------|---|---|---|----------|--------------|-------|---|----------|--------------------------------------|----|----|----------|--|---|----|
| Code      | Description                                       | Image   | Code       | Description                            | Components list  |      |             |     |     |          |                             |   |    |          |   |   |    |          |  |   |    |          |                      |   |    |          |                             |   |    |          |  |   |    |          |   |   |    |          |                              |   |    |          |                    |   |    |          |   |    |    |          |                         |   |    |          |                            |   |    |          |              |   |    |          |                                       |   |    |          |   |       |   |          |   |   |   |          |              |       |   |          |                                      |    |    |          |  |   |    |
| VL1006A   | SYPHON COVER                                      |  | XC648      | LINEMISS TOP<br>XFT200 STACKING<br>KIT | <table border="1"> <thead> <tr> <th>Code</th> <th>Description</th> <th>Qty</th> <th>UOM</th> </tr> </thead> <tbody> <tr> <td>0H1237A0</td> <td>LM TOP<br/>SIPHON<br/>SUPPORT</td> <td>2</td> <td>PZ</td> </tr> <tr> <td>0H7082A0</td> <td>LM 800 XC<br/>STACKING KIT<br/>FRONT<br/>PROFILE</td> <td>1</td> <td>PZ</td> </tr> <tr> <td>0H7083A0</td> <td>LM 800 XC<br/>STACKING KIT<br/>BACK PROFIL</td> <td>2</td> <td>PZ</td> </tr> <tr> <td>ED1246A0</td> <td>HOT SURFACE<br/>LABEL</td> <td>1</td> <td>PZ</td> </tr> <tr> <td>ED1271A0</td> <td>LIQUID FALLS<br/>DANGER LABE</td> <td>1</td> <td>PZ</td> </tr> <tr> <td>EL1020A1</td> <td>D8<br/>INTERMEDIAT<br/>E T-SHAPED<br/>FITTING</td> <td>2</td> <td>PZ</td> </tr> <tr> <td>EL1180A0</td> <td>Ø8-Ø8<br/>FEMALE<br/>NON-RETURN<br/>CONNECTION</td> <td>2</td> <td>PZ</td> </tr> <tr> <td>GN1508A0</td> <td>O-RING<br/>GASKET COD<br/>2400</td> <td>2</td> <td>PZ</td> </tr> <tr> <td>RC1008A0</td> <td>D9 ELASTIC<br/>CLIP</td> <td>7</td> <td>PZ</td> </tr> <tr> <td>RC1055A0</td> <td>Ø25-40 H12<br/>STAINLESS<br/>STEEL PIPE<br/>CLIP</td> <td>10</td> <td>PZ</td> </tr> <tr> <td>RC1297A1</td> <td>D10 T-SHAPED<br/>FITTING</td> <td>1</td> <td>PZ</td> </tr> <tr> <td>RC1360A0</td> <td>10 - 10 JG<br/>ELBOW FITTIN</td> <td>1</td> <td>PZ</td> </tr> <tr> <td>RC1376A0</td> <td>Ø6 Y-FITTING</td> <td>1</td> <td>PZ</td> </tr> <tr> <td>TB1177A0</td> <td>FOOT PANEL<br/>40X40 H58<br/>OVERLAP LM</td> <td>4</td> <td>PZ</td> </tr> <tr> <td>TB1520A0</td> <td>INT. Ø=38<br/>TH=4 DRAIN<br/>BLACK<br/>RUBBER PIPE</td> <td>2.700</td> <td>M</td> </tr> <tr> <td>TB1815A0</td> <td>7,93X4,75 PE<br/>TRANSP. PIPE<br/>(JG<br/>#PE08100N)</td> <td>2</td> <td>M</td> </tr> <tr> <td>TB2243A0</td> <td>Ø10 PET PIPE</td> <td>1.500</td> <td>M</td> </tr> <tr> <td>VI1220A1</td> <td>4,2X12 TCB<br/>SELF-TAPPIN<br/>G SCREW</td> <td>16</td> <td>PZ</td> </tr> <tr> <td>VI1895A0</td> <td>BLIND NUT M4<br/>STAINLESS<br/>STEEL DIN 917</td> <td>8</td> <td>PZ</td> </tr> </tbody> </table> | Code | Description | Qty | UOM | 0H1237A0 | LM TOP<br>SIPHON<br>SUPPORT | 2 | PZ | 0H7082A0 | LM 800 XC<br>STACKING KIT<br>FRONT<br>PROFILE | 1 | PZ | 0H7083A0 | LM 800 XC<br>STACKING KIT<br>BACK PROFIL | 2 | PZ | ED1246A0 | HOT SURFACE<br>LABEL | 1 | PZ | ED1271A0 | LIQUID FALLS<br>DANGER LABE | 1 | PZ | EL1020A1 | D8<br>INTERMEDIAT<br>E T-SHAPED<br>FITTING | 2 | PZ | EL1180A0 | Ø8-Ø8<br>FEMALE<br>NON-RETURN<br>CONNECTION | 2 | PZ | GN1508A0 | O-RING<br>GASKET COD<br>2400 | 2 | PZ | RC1008A0 | D9 ELASTIC<br>CLIP | 7 | PZ | RC1055A0 | Ø25-40 H12<br>STAINLESS<br>STEEL PIPE<br>CLIP | 10 | PZ | RC1297A1 | D10 T-SHAPED<br>FITTING | 1 | PZ | RC1360A0 | 10 - 10 JG<br>ELBOW FITTIN | 1 | PZ | RC1376A0 | Ø6 Y-FITTING | 1 | PZ | TB1177A0 | FOOT PANEL<br>40X40 H58<br>OVERLAP LM | 4 | PZ | TB1520A0 | INT. Ø=38<br>TH=4 DRAIN<br>BLACK<br>RUBBER PIPE | 2.700 | M | TB1815A0 | 7,93X4,75 PE<br>TRANSP. PIPE<br>(JG<br>#PE08100N) | 2 | M | TB2243A0 | Ø10 PET PIPE | 1.500 | M | VI1220A1 | 4,2X12 TCB<br>SELF-TAPPIN<br>G SCREW | 16 | PZ | VI1895A0 | BLIND NUT M4<br>STAINLESS<br>STEEL DIN 917 | 8 | PZ |
| Code      | Description                                       | Qty   | UOM        |  |  |      |             |     |     |          |                             |   |    |          |   |   |    |          |  |   |    |          |                      |   |    |          |                             |   |    |          |  |   |    |          |   |   |    |          |                              |   |    |          |                    |   |    |          |   |    |    |          |                         |   |    |          |                            |   |    |          |              |   |    |          |                                       |   |    |          |   |       |   |          |   |   |   |          |              |       |   |          |                                      |    |    |          |  |   |    |
| 0H1237A0  | LM TOP<br>SIPHON<br>SUPPORT                       | 2   | PZ         |  |  |      |             |     |     |          |                             |   |    |          |   |   |    |          |  |   |    |          |                      |   |    |          |                             |   |    |          |  |   |    |          |   |   |    |          |                              |   |    |          |                    |   |    |          |   |    |    |          |                         |   |    |          |                            |   |    |          |              |   |    |          |                                       |   |    |          |   |       |   |          |   |   |   |          |              |       |   |          |                                      |    |    |          |  |   |    |
| 0H7082A0  | LM 800 XC<br>STACKING KIT<br>FRONT<br>PROFILE     | 1   | PZ         |  |  |      |             |     |     |          |                             |   |    |          |   |   |    |          |  |   |    |          |                      |   |    |          |                             |   |    |          |  |   |    |          |   |   |    |          |                              |   |    |          |                    |   |    |          |   |    |    |          |                         |   |    |          |                            |   |    |          |              |   |    |          |                                       |   |    |          |   |       |   |          |   |   |   |          |              |       |   |          |                                      |    |    |          |  |   |    |
| 0H7083A0  | LM 800 XC<br>STACKING KIT<br>BACK PROFIL          | 2   | PZ         |  |  |      |             |     |     |          |                             |   |    |          |   |   |    |          |  |   |    |          |                      |   |    |          |                             |   |    |          |  |   |    |          |   |   |    |          |                              |   |    |          |                    |   |    |          |   |    |    |          |                         |   |    |          |                            |   |    |          |              |   |    |          |                                       |   |    |          |   |       |   |          |   |   |   |          |              |       |   |          |                                      |    |    |          |  |   |    |
| ED1246A0  | HOT SURFACE<br>LABEL                              | 1   | PZ         |  |  |      |             |     |     |          |                             |   |    |          |   |   |    |          |  |   |    |          |                      |   |    |          |                             |   |    |          |  |   |    |          |   |   |    |          |                              |   |    |          |                    |   |    |          |   |    |    |          |                         |   |    |          |                            |   |    |          |              |   |    |          |                                       |   |    |          |   |       |   |          |   |   |   |          |              |       |   |          |                                      |    |    |          |  |   |    |
| ED1271A0  | LIQUID FALLS<br>DANGER LABE                       | 1   | PZ         |  |  |      |             |     |     |          |                             |   |    |          |   |   |    |          |  |   |    |          |                      |   |    |          |                             |   |    |          |  |   |    |          |   |   |    |          |                              |   |    |          |                    |   |    |          |   |    |    |          |                         |   |    |          |                            |   |    |          |              |   |    |          |                                       |   |    |          |   |       |   |          |   |   |   |          |              |       |   |          |                                      |    |    |          |  |   |    |
| EL1020A1  | D8<br>INTERMEDIAT<br>E T-SHAPED<br>FITTING        | 2   | PZ         |  |  |      |             |     |     |          |                             |   |    |          |   |   |    |          |  |   |    |          |                      |   |    |          |                             |   |    |          |  |   |    |          |   |   |    |          |                              |   |    |          |                    |   |    |          |   |    |    |          |                         |   |    |          |                            |   |    |          |              |   |    |          |                                       |   |    |          |   |       |   |          |   |   |   |          |              |       |   |          |                                      |    |    |          |  |   |    |
| EL1180A0  | Ø8-Ø8<br>FEMALE<br>NON-RETURN<br>CONNECTION       | 2   | PZ         |  |  |      |             |     |     |          |                             |   |    |          |   |   |    |          |  |   |    |          |                      |   |    |          |                             |   |    |          |  |   |    |          |   |   |    |          |                              |   |    |          |                    |   |    |          |   |    |    |          |                         |   |    |          |                            |   |    |          |              |   |    |          |                                       |   |    |          |   |       |   |          |   |   |   |          |              |       |   |          |                                      |    |    |          |  |   |    |
| GN1508A0  | O-RING<br>GASKET COD<br>2400                      | 2   | PZ         |  |  |      |             |     |     |          |                             |   |    |          |   |   |    |          |  |   |    |          |                      |   |    |          |                             |   |    |          |  |   |    |          |   |   |    |          |                              |   |    |          |                    |   |    |          |   |    |    |          |                         |   |    |          |                            |   |    |          |              |   |    |          |                                       |   |    |          |   |       |   |          |   |   |   |          |              |       |   |          |                                      |    |    |          |  |   |    |
| RC1008A0  | D9 ELASTIC<br>CLIP                                | 7   | PZ         |  |  |      |             |     |     |          |                             |   |    |          |   |   |    |          |  |   |    |          |                      |   |    |          |                             |   |    |          |  |   |    |          |   |   |    |          |                              |   |    |          |                    |   |    |          |   |    |    |          |                         |   |    |          |                            |   |    |          |              |   |    |          |                                       |   |    |          |   |       |   |          |   |   |   |          |              |       |   |          |                                      |    |    |          |  |   |    |
| RC1055A0  | Ø25-40 H12<br>STAINLESS<br>STEEL PIPE<br>CLIP     | 10  | PZ         |  |  |      |             |     |     |          |                             |   |    |          |   |   |    |          |  |   |    |          |                      |   |    |          |                             |   |    |          |  |   |    |          |   |   |    |          |                              |   |    |          |                    |   |    |          |   |    |    |          |                         |   |    |          |                            |   |    |          |              |   |    |          |                                       |   |    |          |   |       |   |          |   |   |   |          |              |       |   |          |                                      |    |    |          |  |   |    |
| RC1297A1  | D10 T-SHAPED<br>FITTING                           | 1   | PZ         |  |  |      |             |     |     |          |                             |   |    |          |   |   |    |          |  |   |    |          |                      |   |    |          |                             |   |    |          |  |   |    |          |   |   |    |          |                              |   |    |          |                    |   |    |          |   |    |    |          |                         |   |    |          |                            |   |    |          |              |   |    |          |                                       |   |    |          |   |       |   |          |   |   |   |          |              |       |   |          |                                      |    |    |          |  |   |    |
| RC1360A0  | 10 - 10 JG<br>ELBOW FITTIN                        | 1   | PZ         |  |  |      |             |     |     |          |                             |   |    |          |   |   |    |          |  |   |    |          |                      |   |    |          |                             |   |    |          |  |   |    |          |   |   |    |          |                              |   |    |          |                    |   |    |          |   |    |    |          |                         |   |    |          |                            |   |    |          |              |   |    |          |                                       |   |    |          |   |       |   |          |   |   |   |          |              |       |   |          |                                      |    |    |          |  |   |    |
| RC1376A0  | Ø6 Y-FITTING                                      | 1   | PZ         |  |  |      |             |     |     |          |                             |   |    |          |   |   |    |          |  |   |    |          |                      |   |    |          |                             |   |    |          |  |   |    |          |   |   |    |          |                              |   |    |          |                    |   |    |          |   |    |    |          |                         |   |    |          |                            |   |    |          |              |   |    |          |                                       |   |    |          |   |       |   |          |   |   |   |          |              |       |   |          |                                      |    |    |          |  |   |    |
| TB1177A0  | FOOT PANEL<br>40X40 H58<br>OVERLAP LM             | 4   | PZ         |  |  |      |             |     |     |          |                             |   |    |          |   |   |    |          |  |   |    |          |                      |   |    |          |                             |   |    |          |  |   |    |          |   |   |    |          |                              |   |    |          |                    |   |    |          |   |    |    |          |                         |   |    |          |                            |   |    |          |              |   |    |          |                                       |   |    |          |   |       |   |          |   |   |   |          |              |       |   |          |                                      |    |    |          |  |   |    |
| TB1520A0  | INT. Ø=38<br>TH=4 DRAIN<br>BLACK<br>RUBBER PIPE   | 2.700   | M          |  |  |      |             |     |     |          |                             |   |    |          |   |   |    |          |  |   |    |          |                      |   |    |          |                             |   |    |          |  |   |    |          |   |   |    |          |                              |   |    |          |                    |   |    |          |   |    |    |          |                         |   |    |          |                            |   |    |          |              |   |    |          |                                       |   |    |          |   |       |   |          |   |   |   |          |              |       |   |          |                                      |    |    |          |  |   |    |
| TB1815A0  | 7,93X4,75 PE<br>TRANSP. PIPE<br>(JG<br>#PE08100N) | 2   | M          |  |  |      |             |     |     |          |                             |   |    |          |   |   |    |          |  |   |    |          |                      |   |    |          |                             |   |    |          |  |   |    |          |   |   |    |          |                              |   |    |          |                    |   |    |          |   |    |    |          |                         |   |    |          |                            |   |    |          |              |   |    |          |                                       |   |    |          |   |       |   |          |   |   |   |          |              |       |   |          |                                      |    |    |          |  |   |    |
| TB2243A0  | Ø10 PET PIPE                                      | 1.500   | M          |  |  |      |             |     |     |          |                             |   |    |          |   |   |    |          |  |   |    |          |                      |   |    |          |                             |   |    |          |  |   |    |          |   |   |    |          |                              |   |    |          |                    |   |    |          |   |    |    |          |                         |   |    |          |                            |   |    |          |              |   |    |          |                                       |   |    |          |   |       |   |          |   |   |   |          |              |       |   |          |                                      |    |    |          |  |   |    |
| VI1220A1  | 4,2X12 TCB<br>SELF-TAPPIN<br>G SCREW              | 16  | PZ         |  |  |      |             |     |     |          |                             |   |    |          |   |   |    |          |  |   |    |          |                      |   |    |          |                             |   |    |          |  |   |    |          |   |   |    |          |                              |   |    |          |                    |   |    |          |   |    |    |          |                         |   |    |          |                            |   |    |          |              |   |    |          |                                       |   |    |          |   |       |   |          |   |   |   |          |              |       |   |          |                                      |    |    |          |  |   |    |
| VI1895A0  | BLIND NUT M4<br>STAINLESS<br>STEEL DIN 917        | 8   | PZ         |  |  |      |             |     |     |          |                             |   |    |          |   |   |    |          |  |   |    |          |                      |   |    |          |                             |   |    |          |  |   |    |          |   |   |    |          |                              |   |    |          |                    |   |    |          |   |    |    |          |                         |   |    |          |                            |   |    |          |              |   |    |          |                                       |   |    |          |   |       |   |          |   |   |   |          |              |       |   |          |                                      |    |    |          |  |   |    |

| COMPONENT |  |   | SPARE PART |  |  |      |             |     |     |          |                                      |   |    |          |  |    |    |          |             |   |    |          |                 |   |    |          |   |   |    |          |   |   |    |          |   |   |    |          |                             |   |    |          |                       |   |    |
|-----------|--|---|------------|--|--|------|-------------|-----|-----|----------|--------------------------------------|---|----|----------|--|----|----|----------|-------------|---|----|----------|-----------------|---|----|----------|---|---|----|----------|---|---|----|----------|---|---|----|----------|-----------------------------|---|----|----------|-----------------------|---|----|
| Code      | Description  | Image   | Code       | Description                            | Components list  |      |             |     |     |          |                                      |   |    |          |  |    |    |          |             |   |    |          |                 |   |    |          |   |   |    |          |   |   |    |          |   |   |    |          |                             |   |    |          |                       |   |    |
| VL1006A   | SYPHON COVER                                       |    | XC648      | LINEMISS TOP<br>XFT200 STACKING<br>KIT | <table border="1"> <thead> <tr> <th>Code</th> <th>Description</th> <th>Qty</th> <th>UOM</th> </tr> </thead> <tbody> <tr> <td>VI1945A0</td> <td>ENG-VITE<br/>M4X20 TCB+<br/>INOX</td> <td>8</td> <td>PZ</td> </tr> <tr> <td>VI1950A0</td> <td>ST. STEEL<br/>4,2X13 TCB<br/>SELF-DRILLIN<br/>G SCREW</td> <td>10</td> <td>PZ</td> </tr> <tr> <td>VL1005A1</td> <td>U-TRAP TANK</td> <td>2</td> <td>PZ</td> </tr> <tr> <td>VL1006A0</td> <td>SYPHON<br/>COVER</td> <td>2</td> <td>PZ</td> </tr> <tr> <td>VL1046A1</td> <td>D6 PIPE<br/>HOLDER - D6<br/>J.G. TERMINAL</td> <td>6</td> <td>PZ</td> </tr> <tr> <td>VL1047A1</td> <td>D6 PIPE<br/>HOLDER - D8<br/>J.G. TERMINAL</td> <td>4</td> <td>PZ</td> </tr> <tr> <td>VM1015A1</td> <td>STAINLESS<br/>STEEL<br/>Ø30X1,5 90°<br/>BEND</td> <td>1</td> <td>PZ</td> </tr> <tr> <td>VM1794A0</td> <td>250X4,8 PA66<br/>BLACK CLAMP</td> <td>2</td> <td>PZ</td> </tr> <tr> <td>VM2035A0</td> <td>DRAIN PIPE<br/>SUPPORT</td> <td>1</td> <td>PZ</td> </tr> </tbody> </table> | Code | Description | Qty | UOM | VI1945A0 | ENG-VITE<br>M4X20 TCB+<br>INOX       | 8 | PZ | VI1950A0 | ST. STEEL<br>4,2X13 TCB<br>SELF-DRILLIN<br>G SCREW | 10 | PZ | VL1005A1 | U-TRAP TANK | 2 | PZ | VL1006A0 | SYPHON<br>COVER | 2 | PZ | VL1046A1 | D6 PIPE<br>HOLDER - D6<br>J.G. TERMINAL | 6 | PZ | VL1047A1 | D6 PIPE<br>HOLDER - D8<br>J.G. TERMINAL | 4 | PZ | VM1015A1 | STAINLESS<br>STEEL<br>Ø30X1,5 90°<br>BEND | 1 | PZ | VM1794A0 | 250X4,8 PA66<br>BLACK CLAMP | 2 | PZ | VM2035A0 | DRAIN PIPE<br>SUPPORT | 1 | PZ |
| Code      | Description  | Qty   | UOM        |  |  |      |             |     |     |          |                                      |   |    |          |  |    |    |          |             |   |    |          |                 |   |    |          |   |   |    |          |   |   |    |          |   |   |    |          |                             |   |    |          |                       |   |    |
| VI1945A0  | ENG-VITE<br>M4X20 TCB+<br>INOX                     | 8   | PZ         |  |  |      |             |     |     |          |                                      |   |    |          |  |    |    |          |             |   |    |          |                 |   |    |          |   |   |    |          |   |   |    |          |   |   |    |          |                             |   |    |          |                       |   |    |
| VI1950A0  | ST. STEEL<br>4,2X13 TCB<br>SELF-DRILLIN<br>G SCREW | 10  | PZ         |  |  |      |             |     |     |          |                                      |   |    |          |  |    |    |          |             |   |    |          |                 |   |    |          |   |   |    |          |   |   |    |          |   |   |    |          |                             |   |    |          |                       |   |    |
| VL1005A1  | U-TRAP TANK  | 2   | PZ         |  |  |      |             |     |     |          |                                      |   |    |          |  |    |    |          |             |   |    |          |                 |   |    |          |   |   |    |          |   |   |    |          |   |   |    |          |                             |   |    |          |                       |   |    |
| VL1006A0  | SYPHON<br>COVER                                    | 2   | PZ         |  |  |      |             |     |     |          |                                      |   |    |          |  |    |    |          |             |   |    |          |                 |   |    |          |   |   |    |          |   |   |    |          |   |   |    |          |                             |   |    |          |                       |   |    |
| VL1046A1  | D6 PIPE<br>HOLDER - D6<br>J.G. TERMINAL            | 6   | PZ         |  |  |      |             |     |     |          |                                      |   |    |          |  |    |    |          |             |   |    |          |                 |   |    |          |   |   |    |          |   |   |    |          |   |   |    |          |                             |   |    |          |                       |   |    |
| VL1047A1  | D6 PIPE<br>HOLDER - D8<br>J.G. TERMINAL            | 4   | PZ         |  |  |      |             |     |     |          |                                      |   |    |          |  |    |    |          |             |   |    |          |                 |   |    |          |   |   |    |          |   |   |    |          |   |   |    |          |                             |   |    |          |                       |   |    |
| VM1015A1  | STAINLESS<br>STEEL<br>Ø30X1,5 90°<br>BEND          | 1   | PZ         |  |  |      |             |     |     |          |                                      |   |    |          |  |    |    |          |             |   |    |          |                 |   |    |          |   |   |    |          |   |   |    |          |   |   |    |          |                             |   |    |          |                       |   |    |
| VM1794A0  | 250X4,8 PA66<br>BLACK CLAMP                        | 2   | PZ         |  |  |      |             |     |     |          |                                      |   |    |          |  |    |    |          |             |   |    |          |                 |   |    |          |   |   |    |          |   |   |    |          |   |   |    |          |                             |   |    |          |                       |   |    |
| VM2035A0  | DRAIN PIPE<br>SUPPORT                              | 1   | PZ         |  |  |      |             |     |     |          |                                      |   |    |          |  |    |    |          |             |   |    |          |                 |   |    |          |   |   |    |          |   |   |    |          |   |   |    |          |                             |   |    |          |                       |   |    |
| VM2036A   | DRAIN WATER PIPE<br>SUPPORT                        |  | KVM2036A   | DRAIN WATER PIPE<br>SUPPORT KIT        | <table border="1"> <thead> <tr> <th>Code</th> <th>Description</th> <th>Qty</th> <th>UOM</th> </tr> </thead> <tbody> <tr> <td>VI1220A1</td> <td>4,2X12 TCB<br/>SELF-TAPPIN<br/>G SCREW</td> <td>2</td> <td>PZ</td> </tr> <tr> <td>VM2036A0</td> <td>DRAIN WATER<br/>PIPE SUPPOR</td> <td>2</td> <td>PZ</td> </tr> </tbody> </table>   | Code | Description | Qty | UOM | VI1220A1 | 4,2X12 TCB<br>SELF-TAPPIN<br>G SCREW | 2 | PZ | VM2036A0 | DRAIN WATER<br>PIPE SUPPOR                         | 2  | PZ |          |             |   |    |          |                 |   |    |          |   |   |    |          |   |   |    |          |   |   |    |          |                             |   |    |          |                       |   |    |
| Code      | Description  | Qty   | UOM        |  |  |      |             |     |     |          |                                      |   |    |          |  |    |    |          |             |   |    |          |                 |   |    |          |   |   |    |          |   |   |    |          |   |   |    |          |                             |   |    |          |                       |   |    |
| VI1220A1  | 4,2X12 TCB<br>SELF-TAPPIN<br>G SCREW               | 2   | PZ         |  |  |      |             |     |     |          |                                      |   |    |          |  |    |    |          |             |   |    |          |                 |   |    |          |   |   |    |          |   |   |    |          |   |   |    |          |                             |   |    |          |                       |   |    |
| VM2036A0  | DRAIN WATER<br>PIPE SUPPOR                         | 2   | PZ         |  |  |      |             |     |     |          |                                      |   |    |          |  |    |    |          |             |   |    |          |                 |   |    |          |   |   |    |          |   |   |    |          |   |   |    |          |                             |   |    |          |                       |   |    |
| TB2939A   | XEVC-2011 WATER<br>DRAIN PIPE                      |  | TB2939A0   | XEVC-2011 WATER<br>DRAIN PIPE          |  |      |             |     |     |          |                                      |   |    |          |  |    |    |          |             |   |    |          |                 |   |    |          |   |   |    |          |   |   |    |          |   |   |    |          |                             |   |    |          |                       |   |    |

| COMPONENT |   |   | SPARE PART |                                |   |      |             |     |     |          |   |       |    |          |                                 |   |    |          |                   |   |    |          |                       |       |   |
|-----------|---|---|------------|--------------------------------|---|------|-------------|-----|-----|----------|---|-------|----|----------|---------------------------------|---|----|----------|-------------------|---|----|----------|-----------------------|-------|---|
| Code      | Description                             | Image   | Code       | Description                    | Components list   |      |             |     |     |          |   |       |    |          |                                 |   |    |          |                   |   |    |          |                       |       |   |
| 0H6567A   | P-TRAP HOLDING PANEL                    |    | 0H6567A0   | P-TRAP HOLDING PANEL           |   |      |             |     |     |          |   |       |    |          |                                 |   |    |          |                   |   |    |          |                       |       |   |
| 0D2312A   | XEVC-2011 LEFT SIDE PANEL               |   | 0D2312A0   | XEVC-2011 LEFT SIDE PANEL      |   |      |             |     |     |          |   |       |    |          |                                 |   |    |          |                   |   |    |          |                       |       |   |
| VE1295A   | MK 16A 230V DOOR MICROSWITCH            |  | KVE1295A   | 16A 230V DOOR MICROSWITCH KIT  | <table border="1"> <thead> <tr> <th>Code</th> <th>Description</th> <th>Qty</th> <th>UOM</th> </tr> </thead> <tbody> <tr> <td>VE1295A0</td> <td>MK 16A 230V DOOR MICROSWITC</td> <td>1</td> <td>PZ</td> </tr> </tbody> </table>  | Code | Description | Qty | UOM | VE1295A0 | MK 16A 230V DOOR MICROSWITC             | 1     | PZ |          |                                 |   |    |          |                   |   |    |          |                       |       |   |
| Code      | Description                             | Qty   | UOM        |                                |   |      |             |     |     |          |   |       |    |          |                                 |   |    |          |                   |   |    |          |                       |       |   |
| VE1295A0  | MK 16A 230V DOOR MICROSWITC             | 1   | PZ         |                                |   |      |             |     |     |          |   |       |    |          |                                 |   |    |          |                   |   |    |          |                       |       |   |
| SB1015A   | 4L DETERGENT TAN                        |  | KSB1015A   | 4L DETERGENT TANK KIT          | <table border="1"> <thead> <tr> <th>Code</th> <th>Description</th> <th>Qty</th> <th>UOM</th> </tr> </thead> <tbody> <tr> <td>IP1385A1</td> <td>CORNER POLYSTYREN E PACKING 110X80X2000</td> <td>1.200</td> <td>M</td> </tr> <tr> <td>IP1410A0</td> <td>POLYSTYREN E PACKING TO PROTECT</td> <td>2</td> <td>PZ</td> </tr> <tr> <td>SB1015A2</td> <td>4L DETERGENT TANK</td> <td>1</td> <td>PZ</td> </tr> <tr> <td>VM1059A1</td> <td>HEAT SHRINK FILM H800</td> <td>1.200</td> <td>M</td> </tr> </tbody> </table> | Code | Description | Qty | UOM | IP1385A1 | CORNER POLYSTYREN E PACKING 110X80X2000 | 1.200 | M  | IP1410A0 | POLYSTYREN E PACKING TO PROTECT | 2 | PZ | SB1015A2 | 4L DETERGENT TANK | 1 | PZ | VM1059A1 | HEAT SHRINK FILM H800 | 1.200 | M |
| Code      | Description                             | Qty   | UOM        |                                |   |      |             |     |     |          |   |       |    |          |                                 |   |    |          |                   |   |    |          |                       |       |   |
| IP1385A1  | CORNER POLYSTYREN E PACKING 110X80X2000 | 1.200   | M          |                                |   |      |             |     |     |          |   |       |    |          |                                 |   |    |          |                   |   |    |          |                       |       |   |
| IP1410A0  | POLYSTYREN E PACKING TO PROTECT         | 2   | PZ         |                                |   |      |             |     |     |          |   |       |    |          |                                 |   |    |          |                   |   |    |          |                       |       |   |
| SB1015A2  | 4L DETERGENT TANK                       | 1   | PZ         |                                |   |      |             |     |     |          |   |       |    |          |                                 |   |    |          |                   |   |    |          |                       |       |   |
| VM1059A1  | HEAT SHRINK FILM H800                   | 1.200   | M          |                                |   |      |             |     |     |          |   |       |    |          |                                 |   |    |          |                   |   |    |          |                       |       |   |
| 0D2314A   | XEVC-2011-E EXTERNAL TOP COVER          |  | 0D2314A0   | XEVC-2011-E EXTERNAL TOP COVER |   |      |             |     |     |          |   |       |    |          |                                 |   |    |          |                   |   |    |          |                       |       |   |

| COMPONENT |  |   | SPARE PART |                                       |  |      |             |     |     |          |                                      |   |    |          |                             |   |    |          |                                   |       |   |          |                          |   |    |          |                                 |   |    |          |                         |   |    |          |  |   |    |
|-----------|--|---|------------|---------------------------------------|--|------|-------------|-----|-----|----------|--------------------------------------|---|----|----------|-----------------------------|---|----|----------|-----------------------------------|-------|---|----------|--------------------------|---|----|----------|---------------------------------|---|----|----------|-------------------------|---|----|----------|--|---|----|
| Code      | Description                            | Image   | Code       | Description                           | Components list  |      |             |     |     |          |                                      |   |    |          |                             |   |    |          |                                   |       |   |          |                          |   |    |          |                                 |   |    |          |                         |   |    |          |  |   |    |
| VM1240A   | NYLON SUPPORT CAP                      |    | KVM1240A   | 4 PCS COUNTER BRACKET SUPPORT CAP KIT | <table border="1"> <thead> <tr> <th>Code</th> <th>Description</th> <th>Qty</th> <th>UOM</th> </tr> </thead> <tbody> <tr> <td>VM1240A0</td> <td>NYLON SUPPORT CAP</td> <td>4</td> <td>PZ</td> </tr> </tbody> </table>   | Code | Description | Qty | UOM | VM1240A0 | NYLON SUPPORT CAP                    | 4 | PZ |          |                             |   |    |          |                                   |       |   |          |                          |   |    |          |                                 |   |    |          |                         |   |    |          |  |   |    |
| Code      | Description                            | Qty   | UOM        |                                       |  |      |             |     |     |          |                                      |   |    |          |                             |   |    |          |                                   |       |   |          |                          |   |    |          |                                 |   |    |          |                         |   |    |          |  |   |    |
| VM1240A0  | NYLON SUPPORT CAP                      | 4   | PZ         |                                       |  |      |             |     |     |          |                                      |   |    |          |                             |   |    |          |                                   |       |   |          |                          |   |    |          |                                 |   |    |          |                         |   |    |          |  |   |    |
| VM2282A   | MICROSWITCH SUPPORT COVER              |    | KVM2282A   | MICROSWITCH SUPPORT PLATE KI          | <table border="1"> <thead> <tr> <th>Code</th> <th>Description</th> <th>Qty</th> <th>UOM</th> </tr> </thead> <tbody> <tr> <td>VM2282A0</td> <td>MICROSWITCH SUPPORT COVER</td> <td>1</td> <td>PZ</td> </tr> </tbody> </table>   | Code | Description | Qty | UOM | VM2282A0 | MICROSWITCH SUPPORT COVER            | 1 | PZ |          |                             |   |    |          |                                   |       |   |          |                          |   |    |          |                                 |   |    |          |                         |   |    |          |  |   |    |
| Code      | Description                            | Qty   | UOM        |                                       |  |      |             |     |     |          |                                      |   |    |          |                             |   |    |          |                                   |       |   |          |                          |   |    |          |                                 |   |    |          |                         |   |    |          |  |   |    |
| VM2282A0  | MICROSWITCH SUPPORT COVER              | 1   | PZ         |                                       |  |      |             |     |     |          |                                      |   |    |          |                             |   |    |          |                                   |       |   |          |                          |   |    |          |                                 |   |    |          |                         |   |    |          |  |   |    |
| VE1020B   | MAGNET DOOR MICROSWITCH                |  | KVE1020B   | MICROSWITCH KIT                       | <table border="1"> <thead> <tr> <th>Code</th> <th>Description</th> <th>Qty</th> <th>UOM</th> </tr> </thead> <tbody> <tr> <td>CE1030A0</td> <td>FEMALE FASTON COVER 6.3X0.8 0.5-1MMQ</td> <td>2</td> <td>PZ</td> </tr> <tr> <td>CE1660A0</td> <td>6.3X0.8 FEMALE FASTON COVER</td> <td>2</td> <td>PZ</td> </tr> <tr> <td>CE1730A0</td> <td>PVC CABLE NP 2 X AWG22 STYLE 2095</td> <td>0.150</td> <td>M</td> </tr> <tr> <td>CE1740A0</td> <td>MINIFIT MALE END FITTING</td> <td>2</td> <td>PZ</td> </tr> <tr> <td>CE1745A0</td> <td>2 WAYS FEMALE MINIFIT CONNECTOR</td> <td>1</td> <td>PZ</td> </tr> <tr> <td>VE1020B0</td> <td>MAGNET DOOR MICROSWITCH</td> <td>1</td> <td>PZ</td> </tr> <tr> <td>VE1030A1</td> <td>MAGNET FOR DOOR MICROSWITCH H D=22,9MM</td> <td>1</td> <td>PZ</td> </tr> </tbody> </table> | Code | Description | Qty | UOM | CE1030A0 | FEMALE FASTON COVER 6.3X0.8 0.5-1MMQ | 2 | PZ | CE1660A0 | 6.3X0.8 FEMALE FASTON COVER | 2 | PZ | CE1730A0 | PVC CABLE NP 2 X AWG22 STYLE 2095 | 0.150 | M | CE1740A0 | MINIFIT MALE END FITTING | 2 | PZ | CE1745A0 | 2 WAYS FEMALE MINIFIT CONNECTOR | 1 | PZ | VE1020B0 | MAGNET DOOR MICROSWITCH | 1 | PZ | VE1030A1 | MAGNET FOR DOOR MICROSWITCH H D=22,9MM | 1 | PZ |
| Code      | Description                            | Qty   | UOM        |                                       |  |      |             |     |     |          |                                      |   |    |          |                             |   |    |          |                                   |       |   |          |                          |   |    |          |                                 |   |    |          |                         |   |    |          |  |   |    |
| CE1030A0  | FEMALE FASTON COVER 6.3X0.8 0.5-1MMQ   | 2   | PZ         |                                       |  |      |             |     |     |          |                                      |   |    |          |                             |   |    |          |                                   |       |   |          |                          |   |    |          |                                 |   |    |          |                         |   |    |          |  |   |    |
| CE1660A0  | 6.3X0.8 FEMALE FASTON COVER            | 2   | PZ         |                                       |  |      |             |     |     |          |                                      |   |    |          |                             |   |    |          |                                   |       |   |          |                          |   |    |          |                                 |   |    |          |                         |   |    |          |  |   |    |
| CE1730A0  | PVC CABLE NP 2 X AWG22 STYLE 2095      | 0.150   | M          |                                       |  |      |             |     |     |          |                                      |   |    |          |                             |   |    |          |                                   |       |   |          |                          |   |    |          |                                 |   |    |          |                         |   |    |          |  |   |    |
| CE1740A0  | MINIFIT MALE END FITTING               | 2   | PZ         |                                       |  |      |             |     |     |          |                                      |   |    |          |                             |   |    |          |                                   |       |   |          |                          |   |    |          |                                 |   |    |          |                         |   |    |          |  |   |    |
| CE1745A0  | 2 WAYS FEMALE MINIFIT CONNECTOR        | 1   | PZ         |                                       |  |      |             |     |     |          |                                      |   |    |          |                             |   |    |          |                                   |       |   |          |                          |   |    |          |                                 |   |    |          |                         |   |    |          |  |   |    |
| VE1020B0  | MAGNET DOOR MICROSWITCH                | 1   | PZ         |                                       |  |      |             |     |     |          |                                      |   |    |          |                             |   |    |          |                                   |       |   |          |                          |   |    |          |                                 |   |    |          |                         |   |    |          |  |   |    |
| VE1030A1  | MAGNET FOR DOOR MICROSWITCH H D=22,9MM | 1   | PZ         |                                       |  |      |             |     |     |          |                                      |   |    |          |                             |   |    |          |                                   |       |   |          |                          |   |    |          |                                 |   |    |          |                         |   |    |          |  |   |    |
| 0H2561A   | 6 S. DOOR COUNTERBRACKET               |  | 0H2561A0   | 6 S. DOOR COUNTERBRACKET              |  |      |             |     |     |          |                                      |   |    |          |                             |   |    |          |                                   |       |   |          |                          |   |    |          |                                 |   |    |          |                         |   |    |          |  |   |    |



| COMPONENT |                                      |   | SPARE PART |                                       |  |      |             |     |     |          |                           |   |    |          |                      |   |    |          |                               |   |    |          |                                     |   |    |
|-----------|--------------------------------------|---|------------|---------------------------------------|--|------|-------------|-----|-----|----------|---------------------------|---|----|----------|----------------------|---|----|----------|-------------------------------|---|----|----------|-------------------------------------|---|----|
| Code      | Description                          | Image   | Code       | Description                           | Components list  |      |             |     |     |          |                           |   |    |          |                      |   |    |          |                               |   |    |          |                                     |   |    |
| VI1995A   | M5X25 ST.STEEL SCREW                 |    | VI1995A0   | M5X25 ST.STEEL SCREW                  |  |      |             |     |     |          |                           |   |    |          |                      |   |    |          |                               |   |    |          |                                     |   |    |
| VM2352A   | LOWER DOOR BRACKET SCREW LEFT COVER  |    | VM2352A0   | LOWER DOOR BRACKET SCREW LEFT COVER   |  |      |             |     |     |          |                           |   |    |          |                      |   |    |          |                               |   |    |          |                                     |   |    |
| VM2353A   | LOWER DOOR BRACKET SCREW RIGHT COVER |  | VM2353A0   | LOWER DOOR BRACKET SCREW RIGHT COVER  |  |      |             |     |     |          |                           |   |    |          |                      |   |    |          |                               |   |    |          |                                     |   |    |
| VM1240A   | NYLON SUPPORT CAP                    |  | KVM1240A   | 4 PCS COUNTER BRACKET SUPPORT CAP KIT | <table border="1"> <thead> <tr> <th>Code</th> <th>Description</th> <th>Qty</th> <th>UOM</th> </tr> </thead> <tbody> <tr> <td>VM1240A0</td> <td>NYLON SUPPORT CAP</td> <td>4</td> <td>PZ</td> </tr> </tbody> </table>   | Code | Description | Qty | UOM | VM1240A0 | NYLON SUPPORT CAP         | 4 | PZ |          |                      |   |    |          |                               |   |    |          |                                     |   |    |
| Code      | Description                          | Qty   | UOM        |                                       |  |      |             |     |     |          |                           |   |    |          |                      |   |    |          |                               |   |    |          |                                     |   |    |
| VM1240A0  | NYLON SUPPORT CAP                    | 4   | PZ         |                                       |  |      |             |     |     |          |                           |   |    |          |                      |   |    |          |                               |   |    |          |                                     |   |    |
| VM2273A   | 6 S. LEFT LOWER DOOR BRACKET         |  | KVM2273A   | MIND.MAPS DOOR LOWER LEFT BRACKET KIT | <table border="1"> <thead> <tr> <th>Code</th> <th>Description</th> <th>Qty</th> <th>UOM</th> </tr> </thead> <tbody> <tr> <td>0H7330A0</td> <td>DOOR LOWER BRACKET WASHER</td> <td>2</td> <td>PZ</td> </tr> <tr> <td>VI1995A0</td> <td>M5X25 ST.STEEL SCREW</td> <td>4</td> <td>PZ</td> </tr> <tr> <td>VM2273A1</td> <td>MM LEFT INFERIOR BRACKET DOOR</td> <td>1</td> <td>PZ</td> </tr> <tr> <td>VM2352A0</td> <td>LOWER DOOR BRACKET SCREW LEFT COVER</td> <td>1</td> <td>PZ</td> </tr> </tbody> </table> | Code | Description | Qty | UOM | 0H7330A0 | DOOR LOWER BRACKET WASHER | 2 | PZ | VI1995A0 | M5X25 ST.STEEL SCREW | 4 | PZ | VM2273A1 | MM LEFT INFERIOR BRACKET DOOR | 1 | PZ | VM2352A0 | LOWER DOOR BRACKET SCREW LEFT COVER | 1 | PZ |
| Code      | Description                          | Qty   | UOM        |                                       |  |      |             |     |     |          |                           |   |    |          |                      |   |    |          |                               |   |    |          |                                     |   |    |
| 0H7330A0  | DOOR LOWER BRACKET WASHER            | 2   | PZ         |                                       |  |      |             |     |     |          |                           |   |    |          |                      |   |    |          |                               |   |    |          |                                     |   |    |
| VI1995A0  | M5X25 ST.STEEL SCREW                 | 4   | PZ         |                                       |  |      |             |     |     |          |                           |   |    |          |                      |   |    |          |                               |   |    |          |                                     |   |    |
| VM2273A1  | MM LEFT INFERIOR BRACKET DOOR        | 1   | PZ         |                                       |  |      |             |     |     |          |                           |   |    |          |                      |   |    |          |                               |   |    |          |                                     |   |    |
| VM2352A0  | LOWER DOOR BRACKET SCREW LEFT COVER  | 1   | PZ         |                                       |  |      |             |     |     |          |                           |   |    |          |                      |   |    |          |                               |   |    |          |                                     |   |    |

| COMPONENT |                                      |   | SPARE PART |  |  |      |             |     |     |          |                                     |   |    |          |                                      |   |    |          |                                      |   |    |
|-----------|--------------------------------------|---|------------|--|--|------|-------------|-----|-----|----------|-------------------------------------|---|----|----------|--------------------------------------|---|----|----------|--------------------------------------|---|----|
| Code      | Description                          | Image   | Code       | Description                            | Components list  |      |             |     |     |          |                                     |   |    |          |                                      |   |    |          |                                      |   |    |
| VM2273A   | 6 S. LEFT LOWER DOOR BRACKET         |    | KVM2273A   | MIND.MAPS DOOR LOWER LEFT BRACKET KIT  | <table border="1"> <thead> <tr> <th>Code</th> <th>Description</th> <th>Qty</th> <th>UOM</th> </tr> </thead> <tbody> <tr> <td>VM2352A0</td> <td>LOWER DOOR BRACKET SCREW LEFT COVER</td> <td>1</td> <td>PZ</td> </tr> <tr> <td>VM2353A0</td> <td>LOWER DOOR BRACKET SCREW RIGHT COVER</td> <td>1</td> <td>PZ</td> </tr> <tr> <td>VM2353A0</td> <td>LOWER DOOR BRACKET SCREW RIGHT COVER</td> <td>1</td> <td>PZ</td> </tr> </tbody> </table> | Code | Description | Qty | UOM | VM2352A0 | LOWER DOOR BRACKET SCREW LEFT COVER | 1 | PZ | VM2353A0 | LOWER DOOR BRACKET SCREW RIGHT COVER | 1 | PZ | VM2353A0 | LOWER DOOR BRACKET SCREW RIGHT COVER | 1 | PZ |
| Code      | Description                          | Qty   | UOM        |  |  |      |             |     |     |          |                                     |   |    |          |                                      |   |    |          |                                      |   |    |
| VM2352A0  | LOWER DOOR BRACKET SCREW LEFT COVER  | 1   | PZ         |  |  |      |             |     |     |          |                                     |   |    |          |                                      |   |    |          |                                      |   |    |
| VM2353A0  | LOWER DOOR BRACKET SCREW RIGHT COVER | 1   | PZ         |  |  |      |             |     |     |          |                                     |   |    |          |                                      |   |    |          |                                      |   |    |
| VM2353A0  | LOWER DOOR BRACKET SCREW RIGHT COVER | 1   | PZ         |  |  |      |             |     |     |          |                                     |   |    |          |                                      |   |    |          |                                      |   |    |
| 0H2561A   | 6 S. DOOR COUNTERBRACKET             |   | 0H2561A0   | 6 S. DOOR COUNTERBRACKET               |  |      |             |     |     |          |                                     |   |    |          |                                      |   |    |          |                                      |   |    |
| VI1995A   | M5X25 ST.STEEL SCREW                 |  | VI1995A0   | M5X25 ST.STEEL SCREW                   |  |      |             |     |     |          |                                     |   |    |          |                                      |   |    |          |                                      |   |    |
| VM1240A   | NYLON SUPPORT CAP                    |  | KVM1240A   | 4 PCS COUNTER BRACKET SUPPORT CAP KIT  | <table border="1"> <thead> <tr> <th>Code</th> <th>Description</th> <th>Qty</th> <th>UOM</th> </tr> </thead> <tbody> <tr> <td>VM1240A0</td> <td>NYLON SUPPORT CAP</td> <td>4</td> <td>PZ</td> </tr> </tbody> </table>   | Code | Description | Qty | UOM | VM1240A0 | NYLON SUPPORT CAP                   | 4 | PZ |          |                                      |   |    |          |                                      |   |    |
| Code      | Description                          | Qty   | UOM        |  |  |      |             |     |     |          |                                     |   |    |          |                                      |   |    |          |                                      |   |    |
| VM1240A0  | NYLON SUPPORT CAP                    | 4   | PZ         |  |  |      |             |     |     |          |                                     |   |    |          |                                      |   |    |          |                                      |   |    |
| VM2298A   | DOOR BRACKET UPPER COVER             |  | KVM2298A   | MIND.MAPS DOOR UPPER BRACKET COVER KIT | <table border="1"> <thead> <tr> <th>Code</th> <th>Description</th> <th>Qty</th> <th>UOM</th> </tr> </thead> <tbody> <tr> <td>VI1220A0</td> <td>SELF-TAPPIN G SCREW 4,2X12 TCB</td> <td>2</td> <td>PZ</td> </tr> <tr> <td>VM2298A0</td> <td>DOOR BRACKET UPPER COVER</td> <td>1</td> <td>PZ</td> </tr> </tbody> </table>  | Code | Description | Qty | UOM | VI1220A0 | SELF-TAPPIN G SCREW 4,2X12 TCB      | 2 | PZ | VM2298A0 | DOOR BRACKET UPPER COVER             | 1 | PZ |          |                                      |   |    |
| Code      | Description                          | Qty   | UOM        |  |  |      |             |     |     |          |                                     |   |    |          |                                      |   |    |          |                                      |   |    |
| VI1220A0  | SELF-TAPPIN G SCREW 4,2X12 TCB       | 2   | PZ         |  |  |      |             |     |     |          |                                     |   |    |          |                                      |   |    |          |                                      |   |    |
| VM2298A0  | DOOR BRACKET UPPER COVER             | 1   | PZ         |  |  |      |             |     |     |          |                                     |   |    |          |                                      |   |    |          |                                      |   |    |

| COMPONENT |   |   | SPARE PART |  |   |      |             |     |     |          |                                     |   |    |          |                                      |   |    |          |   |   |    |          |                         |   |    |          |                          |   |    |
|-----------|---|---|------------|--|---|------|-------------|-----|-----|----------|-------------------------------------|---|----|----------|--------------------------------------|---|----|----------|---|---|----|----------|-------------------------|---|----|----------|--------------------------|---|----|
| Code      | Description                             | Image   | Code       | Description                            | Components list   |      |             |     |     |          |                                     |   |    |          |                                      |   |    |          |   |   |    |          |                         |   |    |          |                          |   |    |
| VM2271A   | LEFT DOOR UPPER BRACKET                 |    | KVM2271A   | MIND.MAPS UPPER LEFT DOOR BRACKET KIT  | <table border="1"> <thead> <tr> <th>Code</th> <th>Description</th> <th>Qty</th> <th>UOM</th> </tr> </thead> <tbody> <tr> <td>VI1220A1</td> <td>4,2X12 TCB SELF-TAPPING SCREW</td> <td>2</td> <td>PZ</td> </tr> <tr> <td>VI1995A0</td> <td>M5X25 ST.STEEL SCREW</td> <td>4</td> <td>PZ</td> </tr> <tr> <td>VI1997A0</td> <td>5X10X1 FLAT WASHER</td> <td>4</td> <td>PZ</td> </tr> <tr> <td>VM2271A0</td> <td>LEFT DOOR UPPER BRACKET</td> <td>1</td> <td>PZ</td> </tr> <tr> <td>VM2298A0</td> <td>DOOR BRACKET UPPER COVER</td> <td>1</td> <td>PZ</td> </tr> </tbody> </table> | Code | Description | Qty | UOM | VI1220A1 | 4,2X12 TCB SELF-TAPPING SCREW       | 2 | PZ | VI1995A0 | M5X25 ST.STEEL SCREW                 | 4 | PZ | VI1997A0 | 5X10X1 FLAT WASHER                      | 4 | PZ | VM2271A0 | LEFT DOOR UPPER BRACKET | 1 | PZ | VM2298A0 | DOOR BRACKET UPPER COVER | 1 | PZ |
| Code      | Description                             | Qty   | UOM        |  |   |      |             |     |     |          |                                     |   |    |          |                                      |   |    |          |   |   |    |          |                         |   |    |          |                          |   |    |
| VI1220A1  | 4,2X12 TCB SELF-TAPPING SCREW           | 2   | PZ         |  |   |      |             |     |     |          |                                     |   |    |          |                                      |   |    |          |   |   |    |          |                         |   |    |          |                          |   |    |
| VI1995A0  | M5X25 ST.STEEL SCREW                    | 4   | PZ         |  |   |      |             |     |     |          |                                     |   |    |          |                                      |   |    |          |   |   |    |          |                         |   |    |          |                          |   |    |
| VI1997A0  | 5X10X1 FLAT WASHER                      | 4   | PZ         |  |   |      |             |     |     |          |                                     |   |    |          |                                      |   |    |          |   |   |    |          |                         |   |    |          |                          |   |    |
| VM2271A0  | LEFT DOOR UPPER BRACKET                 | 1   | PZ         |  |   |      |             |     |     |          |                                     |   |    |          |                                      |   |    |          |   |   |    |          |                         |   |    |          |                          |   |    |
| VM2298A0  | DOOR BRACKET UPPER COVER                | 1   | PZ         |  |   |      |             |     |     |          |                                     |   |    |          |                                      |   |    |          |   |   |    |          |                         |   |    |          |                          |   |    |
| RC1365A   | 3/4"-10 JG FEMALE CONNECTION            |   | KRC1365A   | 3/4"-10 OR 8 JG WATER CONNECTION KIT   | <table border="1"> <thead> <tr> <th>Code</th> <th>Description</th> <th>Qty</th> <th>UOM</th> </tr> </thead> <tbody> <tr> <td>GN1200A1</td> <td>3/4 CONNECTION SEAL D=24 RUBBER+NET</td> <td>1</td> <td>PZ</td> </tr> <tr> <td>RC1002A0</td> <td>JG 10M-8F TERMINAL REDUCTION FITTING</td> <td>1</td> <td>PZ</td> </tr> <tr> <td>RC1365A0</td> <td>3/4"-10 JG FEMALE CONNECTION</td> <td>1</td> <td>PZ</td> </tr> </tbody> </table>  | Code | Description | Qty | UOM | GN1200A1 | 3/4 CONNECTION SEAL D=24 RUBBER+NET | 1 | PZ | RC1002A0 | JG 10M-8F TERMINAL REDUCTION FITTING | 1 | PZ | RC1365A0 | 3/4"-10 JG FEMALE CONNECTION            | 1 | PZ |          |                         |   |    |          |                          |   |    |
| Code      | Description                             | Qty   | UOM        |  |   |      |             |     |     |          |                                     |   |    |          |                                      |   |    |          |   |   |    |          |                         |   |    |          |                          |   |    |
| GN1200A1  | 3/4 CONNECTION SEAL D=24 RUBBER+NET     | 1   | PZ         |  |   |      |             |     |     |          |                                     |   |    |          |                                      |   |    |          |   |   |    |          |                         |   |    |          |                          |   |    |
| RC1002A0  | JG 10M-8F TERMINAL REDUCTION FITTING    | 1   | PZ         |  |   |      |             |     |     |          |                                     |   |    |          |                                      |   |    |          |   |   |    |          |                         |   |    |          |                          |   |    |
| RC1365A0  | 3/4"-10 JG FEMALE CONNECTION            | 1   | PZ         |  |   |      |             |     |     |          |                                     |   |    |          |                                      |   |    |          |   |   |    |          |                         |   |    |          |                          |   |    |
| VL1086A   | LIMESCALE REMOVER NEODYMIUM MAGNET      |  | KVL1086A   | NEODYMIUM MAGNET ANTI-LIMESCALE KI     | <table border="1"> <thead> <tr> <th>Code</th> <th>Description</th> <th>Qty</th> <th>UOM</th> </tr> </thead> <tbody> <tr> <td>VL1086A0</td> <td>LIMESCALE REMOVER NEODYMIUM MAGNET</td> <td>2</td> <td>PZ</td> </tr> </tbody> </table>   | Code | Description | Qty | UOM | VL1086A0 | LIMESCALE REMOVER NEODYMIUM MAGNET  | 2 | PZ |          |                                      |   |    |          |   |   |    |          |                         |   |    |          |                          |   |    |
| Code      | Description                             | Qty   | UOM        |  |   |      |             |     |     |          |                                     |   |    |          |                                      |   |    |          |   |   |    |          |                         |   |    |          |                          |   |    |
| VL1086A0  | LIMESCALE REMOVER NEODYMIUM MAGNET      | 2   | PZ         |  |   |      |             |     |     |          |                                     |   |    |          |                                      |   |    |          |   |   |    |          |                         |   |    |          |                          |   |    |
| VM1054A   | H7.8 PRESSURE REDUCER RING NUT          |  | KVM1054A   | H7.8 PRESSURE REDUCER DIAL KIT         | <table border="1"> <thead> <tr> <th>Code</th> <th>Description</th> <th>Qty</th> <th>UOM</th> </tr> </thead> <tbody> <tr> <td>VM1054A0</td> <td>H7.8 PRESSURE REDUCER RING NUT</td> <td>1</td> <td>PZ</td> </tr> </tbody> </table>   | Code | Description | Qty | UOM | VM1054A0 | H7.8 PRESSURE REDUCER RING NUT      | 1 | PZ |          |                                      |   |    |          |   |   |    |          |                         |   |    |          |                          |   |    |
| Code      | Description                             | Qty   | UOM        |  |   |      |             |     |     |          |                                     |   |    |          |                                      |   |    |          |   |   |    |          |                         |   |    |          |                          |   |    |
| VM1054A0  | H7.8 PRESSURE REDUCER RING NUT          | 1   | PZ         |  |   |      |             |     |     |          |                                     |   |    |          |                                      |   |    |          |   |   |    |          |                         |   |    |          |                          |   |    |
|           |   |   | KVL1117A   | EUR MM 2016+LMT FILTER+PRESS. RED. KIT | <table border="1"> <thead> <tr> <th>Code</th> <th>Description</th> <th>Qty</th> <th>UOM</th> </tr> </thead> <tbody> <tr> <td>0H7472A1</td> <td>DISTRIBUTOR SUPPORT PLATE</td> <td>1</td> <td>PZ</td> </tr> <tr> <td>RC1004A0</td> <td>Ø10-Ø8-8 Y CONNECTION</td> <td>1</td> <td>PZ</td> </tr> <tr> <td>RC1243A0</td> <td>Ø10F-Ø10M ELBOW CONNECTION + JG END KIT</td> <td>1</td> <td>PZ</td> </tr> </tbody> </table>  | Code | Description | Qty | UOM | 0H7472A1 | DISTRIBUTOR SUPPORT PLATE           | 1 | PZ | RC1004A0 | Ø10-Ø8-8 Y CONNECTION                | 1 | PZ | RC1243A0 | Ø10F-Ø10M ELBOW CONNECTION + JG END KIT | 1 | PZ |          |                         |   |    |          |                          |   |    |
| Code      | Description                             | Qty   | UOM        |  |   |      |             |     |     |          |                                     |   |    |          |                                      |   |    |          |   |   |    |          |                         |   |    |          |                          |   |    |
| 0H7472A1  | DISTRIBUTOR SUPPORT PLATE               | 1   | PZ         |  |   |      |             |     |     |          |                                     |   |    |          |                                      |   |    |          |   |   |    |          |                         |   |    |          |                          |   |    |
| RC1004A0  | Ø10-Ø8-8 Y CONNECTION                   | 1   | PZ         |  |   |      |             |     |     |          |                                     |   |    |          |                                      |   |    |          |   |   |    |          |                         |   |    |          |                          |   |    |
| RC1243A0  | Ø10F-Ø10M ELBOW CONNECTION + JG END KIT | 1   | PZ         |  |   |      |             |     |     |          |                                     |   |    |          |                                      |   |    |          |   |   |    |          |                         |   |    |          |                          |   |    |



| COMPONENT |   |   | SPARE PART |  |   |      |             |     |     |           |                                  |   |    |          |                                |   |    |          |   |   |    |          |                                  |   |    |          |                                      |   |    |          |                                   |   |    |          |                       |   |    |          |                                      |   |    |          |                                |   |    |
|-----------|---|---|------------|--|---|------|-------------|-----|-----|-----------|----------------------------------|---|----|----------|--------------------------------|---|----|----------|---|---|----|----------|----------------------------------|---|----|----------|--------------------------------------|---|----|----------|-----------------------------------|---|----|----------|-----------------------|---|----|----------|--------------------------------------|---|----|----------|--------------------------------|---|----|
| Code      | Description                             | Image   | Code       | Description                            | Components list   |      |             |     |     |           |                                  |   |    |          |                                |   |    |          |   |   |    |          |                                  |   |    |          |                                      |   |    |          |                                   |   |    |          |                       |   |    |          |                                      |   |    |          |                                |   |    |
| VM1054A   | H7.8 PRESSURE REDUCER RING NUT          |    | KVL1117A   | EUR MM 2016+LMT FILTER+PRESS. RED. KIT | <table border="1"> <thead> <tr> <th>Code</th> <th>Description</th> <th>Qty</th> <th>UOM</th> </tr> </thead> <tbody> <tr> <td>RC1372A0</td> <td>Ø10M-1/4 M CIL. STRAIGHT FITTING</td> <td>2</td> <td>PZ</td> </tr> <tr> <td>VI1220A1</td> <td>4,2X12 TCB SELF-TAPPIN G SCREW</td> <td>4</td> <td>PZ</td> </tr> <tr> <td>VL1014B1</td> <td>PRESSURE REDUCER WITH DISTRIBUTOR</td> <td>1</td> <td>PZ</td> </tr> <tr> <td>VL1034C0</td> <td>MESH WATER FILTER D10</td> <td>1</td> <td>PZ</td> </tr> <tr> <td>VL1062C0</td> <td>PRESSURE REDUCER-FILTER LOCKING FORK</td> <td>1</td> <td>PZ</td> </tr> <tr> <td>VM1054A0</td> <td>H7.8 PRESSURE REDUCER RING NUT</td> <td>1</td> <td>PZ</td> </tr> </tbody> </table>   | Code | Description | Qty | UOM | RC1372A0  | Ø10M-1/4 M CIL. STRAIGHT FITTING | 2 | PZ | VI1220A1 | 4,2X12 TCB SELF-TAPPIN G SCREW | 4 | PZ | VL1014B1 | PRESSURE REDUCER WITH DISTRIBUTOR       | 1 | PZ | VL1034C0 | MESH WATER FILTER D10            | 1 | PZ | VL1062C0 | PRESSURE REDUCER-FILTER LOCKING FORK | 1 | PZ | VM1054A0 | H7.8 PRESSURE REDUCER RING NUT    | 1 | PZ |          |                       |   |    |          |                                      |   |    |          |                                |   |    |
| Code      | Description                             | Qty   | UOM        |  |   |      |             |     |     |           |                                  |   |    |          |                                |   |    |          |   |   |    |          |                                  |   |    |          |                                      |   |    |          |                                   |   |    |          |                       |   |    |          |                                      |   |    |          |                                |   |    |
| RC1372A0  | Ø10M-1/4 M CIL. STRAIGHT FITTING        | 2   | PZ         |  |   |      |             |     |     |           |                                  |   |    |          |                                |   |    |          |   |   |    |          |                                  |   |    |          |                                      |   |    |          |                                   |   |    |          |                       |   |    |          |                                      |   |    |          |                                |   |    |
| VI1220A1  | 4,2X12 TCB SELF-TAPPIN G SCREW          | 4   | PZ         |  |   |      |             |     |     |           |                                  |   |    |          |                                |   |    |          |   |   |    |          |                                  |   |    |          |                                      |   |    |          |                                   |   |    |          |                       |   |    |          |                                      |   |    |          |                                |   |    |
| VL1014B1  | PRESSURE REDUCER WITH DISTRIBUTOR       | 1   | PZ         |  |   |      |             |     |     |           |                                  |   |    |          |                                |   |    |          |   |   |    |          |                                  |   |    |          |                                      |   |    |          |                                   |   |    |          |                       |   |    |          |                                      |   |    |          |                                |   |    |
| VL1034C0  | MESH WATER FILTER D10                   | 1   | PZ         |  |   |      |             |     |     |           |                                  |   |    |          |                                |   |    |          |   |   |    |          |                                  |   |    |          |                                      |   |    |          |                                   |   |    |          |                       |   |    |          |                                      |   |    |          |                                |   |    |
| VL1062C0  | PRESSURE REDUCER-FILTER LOCKING FORK    | 1   | PZ         |  |   |      |             |     |     |           |                                  |   |    |          |                                |   |    |          |   |   |    |          |                                  |   |    |          |                                      |   |    |          |                                   |   |    |          |                       |   |    |          |                                      |   |    |          |                                |   |    |
| VM1054A0  | H7.8 PRESSURE REDUCER RING NUT          | 1   | PZ         |  |   |      |             |     |     |           |                                  |   |    |          |                                |   |    |          |   |   |    |          |                                  |   |    |          |                                      |   |    |          |                                   |   |    |          |                       |   |    |          |                                      |   |    |          |                                |   |    |
| VL1034C   | MESH WATER FILTER D10                   |  | KVL1117A   | EUR MM 2016+LMT FILTER+PRESS. RED. KIT | <table border="1"> <thead> <tr> <th>Code</th> <th>Description</th> <th>Qty</th> <th>UOM</th> </tr> </thead> <tbody> <tr> <td>OH17472A1</td> <td>DISTRIBUTOR SUPPORT PLATE</td> <td>1</td> <td>PZ</td> </tr> <tr> <td>RC1004A0</td> <td>Ø10-Ø8-8 Y CONNECTION</td> <td>1</td> <td>PZ</td> </tr> <tr> <td>RC1243A0</td> <td>Ø10F-Ø10M ELBOW CONNECTION + JG END KIT</td> <td>1</td> <td>PZ</td> </tr> <tr> <td>RC1372A0</td> <td>Ø10M-1/4 M CIL. STRAIGHT FITTING</td> <td>2</td> <td>PZ</td> </tr> <tr> <td>VI1220A1</td> <td>4,2X12 TCB SELF-TAPPIN G SCREW</td> <td>4</td> <td>PZ</td> </tr> <tr> <td>VL1014B1</td> <td>PRESSURE REDUCER WITH DISTRIBUTOR</td> <td>1</td> <td>PZ</td> </tr> <tr> <td>VL1034C0</td> <td>MESH WATER FILTER D10</td> <td>1</td> <td>PZ</td> </tr> <tr> <td>VL1062C0</td> <td>PRESSURE REDUCER-FILTER LOCKING FORK</td> <td>1</td> <td>PZ</td> </tr> <tr> <td>VM1054A0</td> <td>H7.8 PRESSURE REDUCER RING NUT</td> <td>1</td> <td>PZ</td> </tr> </tbody> </table> | Code | Description | Qty | UOM | OH17472A1 | DISTRIBUTOR SUPPORT PLATE        | 1 | PZ | RC1004A0 | Ø10-Ø8-8 Y CONNECTION          | 1 | PZ | RC1243A0 | Ø10F-Ø10M ELBOW CONNECTION + JG END KIT | 1 | PZ | RC1372A0 | Ø10M-1/4 M CIL. STRAIGHT FITTING | 2 | PZ | VI1220A1 | 4,2X12 TCB SELF-TAPPIN G SCREW       | 4 | PZ | VL1014B1 | PRESSURE REDUCER WITH DISTRIBUTOR | 1 | PZ | VL1034C0 | MESH WATER FILTER D10 | 1 | PZ | VL1062C0 | PRESSURE REDUCER-FILTER LOCKING FORK | 1 | PZ | VM1054A0 | H7.8 PRESSURE REDUCER RING NUT | 1 | PZ |
| Code      | Description                             | Qty   | UOM        |  |   |      |             |     |     |           |                                  |   |    |          |                                |   |    |          |   |   |    |          |                                  |   |    |          |                                      |   |    |          |                                   |   |    |          |                       |   |    |          |                                      |   |    |          |                                |   |    |
| OH17472A1 | DISTRIBUTOR SUPPORT PLATE               | 1   | PZ         |  |   |      |             |     |     |           |                                  |   |    |          |                                |   |    |          |   |   |    |          |                                  |   |    |          |                                      |   |    |          |                                   |   |    |          |                       |   |    |          |                                      |   |    |          |                                |   |    |
| RC1004A0  | Ø10-Ø8-8 Y CONNECTION                   | 1   | PZ         |  |   |      |             |     |     |           |                                  |   |    |          |                                |   |    |          |   |   |    |          |                                  |   |    |          |                                      |   |    |          |                                   |   |    |          |                       |   |    |          |                                      |   |    |          |                                |   |    |
| RC1243A0  | Ø10F-Ø10M ELBOW CONNECTION + JG END KIT | 1   | PZ         |  |   |      |             |     |     |           |                                  |   |    |          |                                |   |    |          |   |   |    |          |                                  |   |    |          |                                      |   |    |          |                                   |   |    |          |                       |   |    |          |                                      |   |    |          |                                |   |    |
| RC1372A0  | Ø10M-1/4 M CIL. STRAIGHT FITTING        | 2   | PZ         |  |   |      |             |     |     |           |                                  |   |    |          |                                |   |    |          |   |   |    |          |                                  |   |    |          |                                      |   |    |          |                                   |   |    |          |                       |   |    |          |                                      |   |    |          |                                |   |    |
| VI1220A1  | 4,2X12 TCB SELF-TAPPIN G SCREW          | 4   | PZ         |  |   |      |             |     |     |           |                                  |   |    |          |                                |   |    |          |   |   |    |          |                                  |   |    |          |                                      |   |    |          |                                   |   |    |          |                       |   |    |          |                                      |   |    |          |                                |   |    |
| VL1014B1  | PRESSURE REDUCER WITH DISTRIBUTOR       | 1   | PZ         |  |   |      |             |     |     |           |                                  |   |    |          |                                |   |    |          |   |   |    |          |                                  |   |    |          |                                      |   |    |          |                                   |   |    |          |                       |   |    |          |                                      |   |    |          |                                |   |    |
| VL1034C0  | MESH WATER FILTER D10                   | 1   | PZ         |  |   |      |             |     |     |           |                                  |   |    |          |                                |   |    |          |   |   |    |          |                                  |   |    |          |                                      |   |    |          |                                   |   |    |          |                       |   |    |          |                                      |   |    |          |                                |   |    |
| VL1062C0  | PRESSURE REDUCER-FILTER LOCKING FORK    | 1   | PZ         |  |   |      |             |     |     |           |                                  |   |    |          |                                |   |    |          |   |   |    |          |                                  |   |    |          |                                      |   |    |          |                                   |   |    |          |                       |   |    |          |                                      |   |    |          |                                |   |    |
| VM1054A0  | H7.8 PRESSURE REDUCER RING NUT          | 1   | PZ         |  |   |      |             |     |     |           |                                  |   |    |          |                                |   |    |          |   |   |    |          |                                  |   |    |          |                                      |   |    |          |                                   |   |    |          |                       |   |    |          |                                      |   |    |          |                                |   |    |



| COMPONENT   |   |   | SPARE PART |  |  |                           |             |     |          |                       |                                      |       |          |   |                       |    |          |                                  |                                      |    |          |                               |   |    |          |                                   |   |    |          |                       |   |    |          |                                      |   |    |          |                                |   |    |
|---|---|---|------------|--|--|---------------------------|-------------|-----|----------|-----------------------|--------------------------------------|-------|----------|---|-----------------------|----|----------|----------------------------------|--------------------------------------|----|----------|-------------------------------|---|----|----------|-----------------------------------|---|----|----------|-----------------------|---|----|----------|--------------------------------------|---|----|----------|--------------------------------|---|----|
| Code  | Description                             | Image   | Code       | Description                            | Components list  |                           |             |     |          |                       |                                      |       |          |   |                       |    |          |                                  |                                      |    |          |                               |   |    |          |                                   |   |    |          |                       |   |    |          |                                      |   |    |          |                                |   |    |
| VL1034C   | MESH WATER FILTER D10                   |    | KVL1034C   | Ø8-Ø10 MESH100 WATER FILTER KIT        | <table border="1"> <thead> <tr> <th>Code</th> <th>Description</th> <th>Qty</th> <th>UOM</th> </tr> </thead> <tbody> <tr> <td>RC1002A0</td> <td>JG 10M-8F TERMINAL REDUCTION FITTING</td> <td>2</td> <td>PZ</td> </tr> <tr> <td>VL1034C0</td> <td>MESH WATER FILTER D10</td> <td>1</td> <td>PZ</td> </tr> <tr> <td>VL1062C0</td> <td>PRESSURE REDUCER-FILTER LOCKING FORK</td> <td>1</td> <td>PZ</td> </tr> </tbody> </table> | Code                      | Description | Qty | UOM      | RC1002A0              | JG 10M-8F TERMINAL REDUCTION FITTING | 2     | PZ       | VL1034C0                                | MESH WATER FILTER D10 | 1  | PZ       | VL1062C0                         | PRESSURE REDUCER-FILTER LOCKING FORK | 1  | PZ       |                               |   |    |          |                                   |   |    |          |                       |   |    |          |                                      |   |    |          |                                |   |    |
|   |   |   |            |  | Code   | Description               | Qty         | UOM |          |                       |                                      |       |          |   |                       |    |          |                                  |                                      |    |          |                               |   |    |          |                                   |   |    |          |                       |   |    |          |                                      |   |    |          |                                |   |    |
| RC1002A0  | JG 10M-8F TERMINAL REDUCTION FITTING    | 2   | PZ         |  |  |                           |             |     |          |                       |                                      |       |          |   |                       |    |          |                                  |                                      |    |          |                               |   |    |          |                                   |   |    |          |                       |   |    |          |                                      |   |    |          |                                |   |    |
| VL1034C0  | MESH WATER FILTER D10                   | 1   | PZ         |  |  |                           |             |     |          |                       |                                      |       |          |   |                       |    |          |                                  |                                      |    |          |                               |   |    |          |                                   |   |    |          |                       |   |    |          |                                      |   |    |          |                                |   |    |
| VL1062C0  | PRESSURE REDUCER-FILTER LOCKING FORK    | 1   | PZ         |  |  |                           |             |     |          |                       |                                      |       |          |   |                       |    |          |                                  |                                      |    |          |                               |   |    |          |                                   |   |    |          |                       |   |    |          |                                      |   |    |          |                                |   |    |
| <table border="1"> <thead> <tr> <th>Code</th> <th>Description</th> <th>Qty</th> <th>UOM</th> </tr> </thead> <tbody> <tr> <td>0H7472A1</td> <td>DISTRIBUTOR SUPPORT PLATE</td> <td>1</td> <td>PZ</td> </tr> <tr> <td>RC1004A0</td> <td>Ø10-Ø8-8 Y CONNECTION</td> <td>1</td> <td>PZ</td> </tr> <tr> <td>RC1243A0</td> <td>Ø10F-Ø10M ELBOW CONNECTION + JG END KIT</td> <td>1</td> <td>PZ</td> </tr> <tr> <td>RC1372A0</td> <td>Ø10M-1/4 M CIL. STRAIGHT FITTING</td> <td>2</td> <td>PZ</td> </tr> <tr> <td>VI1220A1</td> <td>4,2X12 TCB SELF-TAPPING SCREW</td> <td>4</td> <td>PZ</td> </tr> <tr> <td>VL1014B1</td> <td>PRESSURE REDUCER WITH DISTRIBUTOR</td> <td>1</td> <td>PZ</td> </tr> <tr> <td>VL1034C0</td> <td>MESH WATER FILTER D10</td> <td>1</td> <td>PZ</td> </tr> <tr> <td>VL1062C0</td> <td>PRESSURE REDUCER-FILTER LOCKING FORK</td> <td>1</td> <td>PZ</td> </tr> <tr> <td>VM1054A0</td> <td>H7.8 PRESSURE REDUCER RING NUT</td> <td>1</td> <td>PZ</td> </tr> </tbody> </table> | Code                                    | Description   | Qty        | UOM                                    | 0H7472A1   | DISTRIBUTOR SUPPORT PLATE | 1           | PZ  | RC1004A0 | Ø10-Ø8-8 Y CONNECTION | 1                                    | PZ    | RC1243A0 | Ø10F-Ø10M ELBOW CONNECTION + JG END KIT | 1                     | PZ | RC1372A0 | Ø10M-1/4 M CIL. STRAIGHT FITTING | 2                                    | PZ | VI1220A1 | 4,2X12 TCB SELF-TAPPING SCREW | 4 | PZ | VL1014B1 | PRESSURE REDUCER WITH DISTRIBUTOR | 1 | PZ | VL1034C0 | MESH WATER FILTER D10 | 1 | PZ | VL1062C0 | PRESSURE REDUCER-FILTER LOCKING FORK | 1 | PZ | VM1054A0 | H7.8 PRESSURE REDUCER RING NUT | 1 | PZ |
| Code  | Description                             | Qty   | UOM        |  |  |                           |             |     |          |                       |                                      |       |          |   |                       |    |          |                                  |                                      |    |          |                               |   |    |          |                                   |   |    |          |                       |   |    |          |                                      |   |    |          |                                |   |    |
| 0H7472A1  | DISTRIBUTOR SUPPORT PLATE               | 1   | PZ         |  |  |                           |             |     |          |                       |                                      |       |          |   |                       |    |          |                                  |                                      |    |          |                               |   |    |          |                                   |   |    |          |                       |   |    |          |                                      |   |    |          |                                |   |    |
| RC1004A0  | Ø10-Ø8-8 Y CONNECTION                   | 1   | PZ         |  |  |                           |             |     |          |                       |                                      |       |          |   |                       |    |          |                                  |                                      |    |          |                               |   |    |          |                                   |   |    |          |                       |   |    |          |                                      |   |    |          |                                |   |    |
| RC1243A0  | Ø10F-Ø10M ELBOW CONNECTION + JG END KIT | 1   | PZ         |  |  |                           |             |     |          |                       |                                      |       |          |   |                       |    |          |                                  |                                      |    |          |                               |   |    |          |                                   |   |    |          |                       |   |    |          |                                      |   |    |          |                                |   |    |
| RC1372A0  | Ø10M-1/4 M CIL. STRAIGHT FITTING        | 2   | PZ         |  |  |                           |             |     |          |                       |                                      |       |          |   |                       |    |          |                                  |                                      |    |          |                               |   |    |          |                                   |   |    |          |                       |   |    |          |                                      |   |    |          |                                |   |    |
| VI1220A1  | 4,2X12 TCB SELF-TAPPING SCREW           | 4   | PZ         |  |  |                           |             |     |          |                       |                                      |       |          |   |                       |    |          |                                  |                                      |    |          |                               |   |    |          |                                   |   |    |          |                       |   |    |          |                                      |   |    |          |                                |   |    |
| VL1014B1  | PRESSURE REDUCER WITH DISTRIBUTOR       | 1   | PZ         |  |  |                           |             |     |          |                       |                                      |       |          |   |                       |    |          |                                  |                                      |    |          |                               |   |    |          |                                   |   |    |          |                       |   |    |          |                                      |   |    |          |                                |   |    |
| VL1034C0  | MESH WATER FILTER D10                   | 1   | PZ         |  |  |                           |             |     |          |                       |                                      |       |          |   |                       |    |          |                                  |                                      |    |          |                               |   |    |          |                                   |   |    |          |                       |   |    |          |                                      |   |    |          |                                |   |    |
| VL1062C0  | PRESSURE REDUCER-FILTER LOCKING FORK    | 1   | PZ         |  |  |                           |             |     |          |                       |                                      |       |          |   |                       |    |          |                                  |                                      |    |          |                               |   |    |          |                                   |   |    |          |                       |   |    |          |                                      |   |    |          |                                |   |    |
| VM1054A0  | H7.8 PRESSURE REDUCER RING NUT          | 1   | PZ         |  |  |                           |             |     |          |                       |                                      |       |          |   |                       |    |          |                                  |                                      |    |          |                               |   |    |          |                                   |   |    |          |                       |   |    |          |                                      |   |    |          |                                |   |    |
| VL1062C   | PRESSURE REDUCER-FILTER LOCKING FORK    |   | KVL1117A   | EUR MM 2016+LMT FILTER+PRESS. RED. KIT | <table border="1"> <thead> <tr> <th>Code</th> <th>Description</th> <th>Qty</th> <th>UOM</th> </tr> </thead> <tbody> <tr> <td>TB2243A0</td> <td>Ø10 PET PIPE</td> <td>1.500</td> <td>M</td> </tr> </tbody> </table>   | Code                      | Description | Qty | UOM      | TB2243A0              | Ø10 PET PIPE                         | 1.500 | M        |   |                       |    |          |                                  |                                      |    |          |                               |   |    |          |                                   |   |    |          |                       |   |    |          |                                      |   |    |          |                                |   |    |
|   |   |   |            |  | Code   | Description               | Qty         | UOM |          |                       |                                      |       |          |   |                       |    |          |                                  |                                      |    |          |                               |   |    |          |                                   |   |    |          |                       |   |    |          |                                      |   |    |          |                                |   |    |
| TB2243A0  | Ø10 PET PIPE                            | 1.500   | M          |  |  |                           |             |     |          |                       |                                      |       |          |   |                       |    |          |                                  |                                      |    |          |                               |   |    |          |                                   |   |    |          |                       |   |    |          |                                      |   |    |          |                                |   |    |
| <table border="1"> <thead> <tr> <th>Code</th> <th>Description</th> <th>Qty</th> <th>UOM</th> </tr> </thead> <tbody> <tr> <td>TB2243A0</td> <td>Ø10 PET PIPE</td> <td>1.500</td> <td>M</td> </tr> </tbody> </table>  | Code                                    | Description   | Qty        | UOM                                    | TB2243A0   | Ø10 PET PIPE              | 1.500       | M   |          |                       |                                      |       |          |   |                       |    |          |                                  |                                      |    |          |                               |   |    |          |                                   |   |    |          |                       |   |    |          |                                      |   |    |          |                                |   |    |
| Code  | Description                             | Qty   | UOM        |  |  |                           |             |     |          |                       |                                      |       |          |   |                       |    |          |                                  |                                      |    |          |                               |   |    |          |                                   |   |    |          |                       |   |    |          |                                      |   |    |          |                                |   |    |
| TB2243A0  | Ø10 PET PIPE                            | 1.500   | M          |  |  |                           |             |     |          |                       |                                      |       |          |   |                       |    |          |                                  |                                      |    |          |                               |   |    |          |                                   |   |    |          |                       |   |    |          |                                      |   |    |          |                                |   |    |
| VL1125A   | BENDED FITTING M-M RUBBER-HOLDER D8-END |  | KTB2237A   | 1,5M D10 TB2243A CONNECTION PIPE KIT   | <table border="1"> <thead> <tr> <th>Code</th> <th>Description</th> <th>Qty</th> <th>UOM</th> </tr> </thead> <tbody> <tr> <td>TB2243A0</td> <td>Ø10 PET PIPE</td> <td>1.500</td> <td>M</td> </tr> </tbody> </table>   | Code                      | Description | Qty | UOM      | TB2243A0              | Ø10 PET PIPE                         | 1.500 | M        |   |                       |    |          |                                  |                                      |    |          |                               |   |    |          |                                   |   |    |          |                       |   |    |          |                                      |   |    |          |                                |   |    |
| Code  | Description                             | Qty   | UOM        |  |  |                           |             |     |          |                       |                                      |       |          |   |                       |    |          |                                  |                                      |    |          |                               |   |    |          |                                   |   |    |          |                       |   |    |          |                                      |   |    |          |                                |   |    |
| TB2243A0  | Ø10 PET PIPE                            | 1.500   | M          |  |  |                           |             |     |          |                       |                                      |       |          |   |                       |    |          |                                  |                                      |    |          |                               |   |    |          |                                   |   |    |          |                       |   |    |          |                                      |   |    |          |                                |   |    |

| COMPONENT |   |   | SPARE PART |  |  |             |             |                                  |     |          |                           |   |    |          |                       |   |    |          |   |   |    |          |                                  |   |    |          |                                |   |    |          |                                   |   |    |          |                       |   |    |          |                                      |   |    |          |                                |   |    |
|-----------|---|---|------------|--|--|-------------|-------------|----------------------------------|-----|----------|---------------------------|---|----|----------|-----------------------|---|----|----------|---|---|----|----------|----------------------------------|---|----|----------|--------------------------------|---|----|----------|-----------------------------------|---|----|----------|-----------------------|---|----|----------|--------------------------------------|---|----|----------|--------------------------------|---|----|
| Code      | Description                                   | Image   | Code       | Description                                  | Components list  |             |             |                                  |     |          |                           |   |    |          |                       |   |    |          |   |   |    |          |                                  |   |    |          |                                |   |    |          |                                   |   |    |          |                       |   |    |          |                                      |   |    |          |                                |   |    |
| RC1372A   | Ø10M-1/4 M CIL.<br>STRAIGHT FITTING           |    | KVL1117A   | EUR MM 2016+LMT<br>FILTER+PRESS.<br>RED. KIT | <table border="1"> <thead> <tr> <th>Code</th> <th>Description</th> <th>Qty</th> <th>UOM</th> </tr> </thead> <tbody> <tr> <td>0H7472A1</td> <td>DISTRIBUTOR SUPPORT PLATE</td> <td>1</td> <td>PZ</td> </tr> <tr> <td>RC1004A0</td> <td>Ø10-Ø8-8 Y CONNECTION</td> <td>1</td> <td>PZ</td> </tr> <tr> <td>RC1243A0</td> <td>Ø10F-Ø10M ELBOW CONNECTION + JG END KIT</td> <td>1</td> <td>PZ</td> </tr> <tr> <td>RC1372A0</td> <td>Ø10M-1/4 M CIL. STRAIGHT FITTING</td> <td>2</td> <td>PZ</td> </tr> <tr> <td>VI1220A1</td> <td>4,2X12 TCB SELF-TAPPIN G SCREW</td> <td>4</td> <td>PZ</td> </tr> <tr> <td>VL1014B1</td> <td>PRESSURE REDUCER WITH DISTRIBUTOR</td> <td>1</td> <td>PZ</td> </tr> <tr> <td>VL1034C0</td> <td>MESH WATER FILTER D10</td> <td>1</td> <td>PZ</td> </tr> <tr> <td>VL1062C0</td> <td>PRESSURE REDUCER-FILTER LOCKING FORK</td> <td>1</td> <td>PZ</td> </tr> <tr> <td>VM1054A0</td> <td>H7.8 PRESSURE REDUCER RING NUT</td> <td>1</td> <td>PZ</td> </tr> </tbody> </table> | Code        | Description | Qty                              | UOM | 0H7472A1 | DISTRIBUTOR SUPPORT PLATE | 1 | PZ | RC1004A0 | Ø10-Ø8-8 Y CONNECTION | 1 | PZ | RC1243A0 | Ø10F-Ø10M ELBOW CONNECTION + JG END KIT | 1 | PZ | RC1372A0 | Ø10M-1/4 M CIL. STRAIGHT FITTING | 2 | PZ | VI1220A1 | 4,2X12 TCB SELF-TAPPIN G SCREW | 4 | PZ | VL1014B1 | PRESSURE REDUCER WITH DISTRIBUTOR | 1 | PZ | VL1034C0 | MESH WATER FILTER D10 | 1 | PZ | VL1062C0 | PRESSURE REDUCER-FILTER LOCKING FORK | 1 | PZ | VM1054A0 | H7.8 PRESSURE REDUCER RING NUT | 1 | PZ |
|           |   |   |            |  | Code   | Description | Qty         | UOM                              |     |          |                           |   |    |          |                       |   |    |          |   |   |    |          |                                  |   |    |          |                                |   |    |          |                                   |   |    |          |                       |   |    |          |                                      |   |    |          |                                |   |    |
| 0H7472A1  | DISTRIBUTOR SUPPORT PLATE                     | 1   | PZ         |  |  |             |             |                                  |     |          |                           |   |    |          |                       |   |    |          |   |   |    |          |                                  |   |    |          |                                |   |    |          |                                   |   |    |          |                       |   |    |          |                                      |   |    |          |                                |   |    |
| RC1004A0  | Ø10-Ø8-8 Y CONNECTION                         | 1   | PZ         |  |  |             |             |                                  |     |          |                           |   |    |          |                       |   |    |          |   |   |    |          |                                  |   |    |          |                                |   |    |          |                                   |   |    |          |                       |   |    |          |                                      |   |    |          |                                |   |    |
| RC1243A0  | Ø10F-Ø10M ELBOW CONNECTION + JG END KIT       | 1   | PZ         |  |  |             |             |                                  |     |          |                           |   |    |          |                       |   |    |          |   |   |    |          |                                  |   |    |          |                                |   |    |          |                                   |   |    |          |                       |   |    |          |                                      |   |    |          |                                |   |    |
| RC1372A0  | Ø10M-1/4 M CIL. STRAIGHT FITTING              | 2   | PZ         |  |  |             |             |                                  |     |          |                           |   |    |          |                       |   |    |          |   |   |    |          |                                  |   |    |          |                                |   |    |          |                                   |   |    |          |                       |   |    |          |                                      |   |    |          |                                |   |    |
| VI1220A1  | 4,2X12 TCB SELF-TAPPIN G SCREW                | 4   | PZ         |  |  |             |             |                                  |     |          |                           |   |    |          |                       |   |    |          |   |   |    |          |                                  |   |    |          |                                |   |    |          |                                   |   |    |          |                       |   |    |          |                                      |   |    |          |                                |   |    |
| VL1014B1  | PRESSURE REDUCER WITH DISTRIBUTOR             | 1   | PZ         |  |  |             |             |                                  |     |          |                           |   |    |          |                       |   |    |          |   |   |    |          |                                  |   |    |          |                                |   |    |          |                                   |   |    |          |                       |   |    |          |                                      |   |    |          |                                |   |    |
| VL1034C0  | MESH WATER FILTER D10                         | 1   | PZ         |  |  |             |             |                                  |     |          |                           |   |    |          |                       |   |    |          |   |   |    |          |                                  |   |    |          |                                |   |    |          |                                   |   |    |          |                       |   |    |          |                                      |   |    |          |                                |   |    |
| VL1062C0  | PRESSURE REDUCER-FILTER LOCKING FORK          | 1   | PZ         |  |  |             |             |                                  |     |          |                           |   |    |          |                       |   |    |          |   |   |    |          |                                  |   |    |          |                                |   |    |          |                                   |   |    |          |                       |   |    |          |                                      |   |    |          |                                |   |    |
| VM1054A0  | H7.8 PRESSURE REDUCER RING NUT                | 1   | PZ         |  |  |             |             |                                  |     |          |                           |   |    |          |                       |   |    |          |   |   |    |          |                                  |   |    |          |                                |   |    |          |                                   |   |    |          |                       |   |    |          |                                      |   |    |          |                                |   |    |
| KRC1372A  | D 10M-1/4 M CIL<br>STRAIGHT<br>CONNECTION KIT | <table border="1"> <thead> <tr> <th>Code</th> <th>Description</th> <th>Qty</th> <th>UOM</th> </tr> </thead> <tbody> <tr> <td>RC1372A0</td> <td>Ø10M-1/4 M CIL. STRAIGHT FITTING</td> <td>1</td> <td>PZ</td> </tr> </tbody> </table> | Code       | Description                                  | Qty  | UOM         | RC1372A0    | Ø10M-1/4 M CIL. STRAIGHT FITTING | 1   | PZ       |                           |   |    |          |                       |   |    |          |   |   |    |          |                                  |   |    |          |                                |   |    |          |                                   |   |    |          |                       |   |    |          |                                      |   |    |          |                                |   |    |
| Code      | Description                                   | Qty   | UOM        |  |  |             |             |                                  |     |          |                           |   |    |          |                       |   |    |          |   |   |    |          |                                  |   |    |          |                                |   |    |          |                                   |   |    |          |                       |   |    |          |                                      |   |    |          |                                |   |    |
| RC1372A0  | Ø10M-1/4 M CIL. STRAIGHT FITTING              | 1   | PZ         |  |  |             |             |                                  |     |          |                           |   |    |          |                       |   |    |          |   |   |    |          |                                  |   |    |          |                                |   |    |          |                                   |   |    |          |                       |   |    |          |                                      |   |    |          |                                |   |    |
| VL1014B   | PRESSURE REDUCER WITH DISTRIBUTOR             |    | KVL1117A   | EUR MM 2016+LMT<br>FILTER+PRESS.<br>RED. KIT | <table border="1"> <thead> <tr> <th>Code</th> <th>Description</th> <th>Qty</th> <th>UOM</th> </tr> </thead> <tbody> <tr> <td>0H7472A1</td> <td>DISTRIBUTOR SUPPORT PLATE</td> <td>1</td> <td>PZ</td> </tr> <tr> <td>RC1004A0</td> <td>Ø10-Ø8-8 Y CONNECTION</td> <td>1</td> <td>PZ</td> </tr> <tr> <td>RC1243A0</td> <td>Ø10F-Ø10M ELBOW CONNECTION + JG END KIT</td> <td>1</td> <td>PZ</td> </tr> <tr> <td>RC1372A0</td> <td>Ø10M-1/4 M CIL. STRAIGHT FITTING</td> <td>2</td> <td>PZ</td> </tr> <tr> <td>VI1220A1</td> <td>4,2X12 TCB SELF-TAPPIN G SCREW</td> <td>4</td> <td>PZ</td> </tr> <tr> <td>VL1014B1</td> <td>PRESSURE REDUCER WITH DISTRIBUTOR</td> <td>1</td> <td>PZ</td> </tr> </tbody> </table>  | Code        | Description | Qty                              | UOM | 0H7472A1 | DISTRIBUTOR SUPPORT PLATE | 1 | PZ | RC1004A0 | Ø10-Ø8-8 Y CONNECTION | 1 | PZ | RC1243A0 | Ø10F-Ø10M ELBOW CONNECTION + JG END KIT | 1 | PZ | RC1372A0 | Ø10M-1/4 M CIL. STRAIGHT FITTING | 2 | PZ | VI1220A1 | 4,2X12 TCB SELF-TAPPIN G SCREW | 4 | PZ | VL1014B1 | PRESSURE REDUCER WITH DISTRIBUTOR | 1 | PZ |          |                       |   |    |          |                                      |   |    |          |                                |   |    |
| Code      | Description                                   | Qty   | UOM        |  |  |             |             |                                  |     |          |                           |   |    |          |                       |   |    |          |   |   |    |          |                                  |   |    |          |                                |   |    |          |                                   |   |    |          |                       |   |    |          |                                      |   |    |          |                                |   |    |
| 0H7472A1  | DISTRIBUTOR SUPPORT PLATE                     | 1   | PZ         |  |  |             |             |                                  |     |          |                           |   |    |          |                       |   |    |          |   |   |    |          |                                  |   |    |          |                                |   |    |          |                                   |   |    |          |                       |   |    |          |                                      |   |    |          |                                |   |    |
| RC1004A0  | Ø10-Ø8-8 Y CONNECTION                         | 1   | PZ         |  |  |             |             |                                  |     |          |                           |   |    |          |                       |   |    |          |   |   |    |          |                                  |   |    |          |                                |   |    |          |                                   |   |    |          |                       |   |    |          |                                      |   |    |          |                                |   |    |
| RC1243A0  | Ø10F-Ø10M ELBOW CONNECTION + JG END KIT       | 1   | PZ         |  |  |             |             |                                  |     |          |                           |   |    |          |                       |   |    |          |   |   |    |          |                                  |   |    |          |                                |   |    |          |                                   |   |    |          |                       |   |    |          |                                      |   |    |          |                                |   |    |
| RC1372A0  | Ø10M-1/4 M CIL. STRAIGHT FITTING              | 2   | PZ         |  |  |             |             |                                  |     |          |                           |   |    |          |                       |   |    |          |   |   |    |          |                                  |   |    |          |                                |   |    |          |                                   |   |    |          |                       |   |    |          |                                      |   |    |          |                                |   |    |
| VI1220A1  | 4,2X12 TCB SELF-TAPPIN G SCREW                | 4   | PZ         |  |  |             |             |                                  |     |          |                           |   |    |          |                       |   |    |          |   |   |    |          |                                  |   |    |          |                                |   |    |          |                                   |   |    |          |                       |   |    |          |                                      |   |    |          |                                |   |    |
| VL1014B1  | PRESSURE REDUCER WITH DISTRIBUTOR             | 1   | PZ         |  |  |             |             |                                  |     |          |                           |   |    |          |                       |   |    |          |   |   |    |          |                                  |   |    |          |                                |   |    |          |                                   |   |    |          |                       |   |    |          |                                      |   |    |          |                                |   |    |

| COMPONENT |   |   | SPARE PART |  |  |      |             |                                      |     |          |                       |                                   |    |          |                                      |                                   |    |          |                                |                                |    |    |
|-----------|---|---|------------|--|--|------|-------------|--------------------------------------|-----|----------|-----------------------|-----------------------------------|----|----------|--------------------------------------|-----------------------------------|----|----------|--------------------------------|--------------------------------|----|----|
| Code      | Description                             | Image   | Code       | Description                            | Components list  |      |             |                                      |     |          |                       |                                   |    |          |                                      |                                   |    |          |                                |                                |    |    |
| VL1014B   | PRESSURE REDUCER WITH DISTRIBUTOR       |    | KVL1117A   | EUR MM 2016+LMT FILTER+PRESS. RED. KIT | <table border="1"> <thead> <tr> <th>Code</th> <th>Description</th> <th>Qty</th> <th>UOM</th> </tr> </thead> <tbody> <tr> <td>VL1034C0</td> <td>MESH WATER FILTER D10</td> <td>1</td> <td>PZ</td> </tr> <tr> <td>VL1062C0</td> <td>PRESSURE REDUCER-FILTER LOCKING FORK</td> <td>1</td> <td>PZ</td> </tr> <tr> <td>VM1054A0</td> <td>H7.8 PRESSURE REDUCER RING NUT</td> <td>1</td> <td>PZ</td> </tr> </tbody> </table> | Code | Description | Qty                                  | UOM | VL1034C0 | MESH WATER FILTER D10 | 1                                 | PZ | VL1062C0 | PRESSURE REDUCER-FILTER LOCKING FORK | 1                                 | PZ | VM1054A0 | H7.8 PRESSURE REDUCER RING NUT | 1                              | PZ |    |
|           |   |   | Code       | Description                            | Qty  | UOM  |             |                                      |     |          |                       |                                   |    |          |                                      |                                   |    |          |                                |                                |    |    |
|           |   |   | VL1034C0   | MESH WATER FILTER D10                  | 1  | PZ   |             |                                      |     |          |                       |                                   |    |          |                                      |                                   |    |          |                                |                                |    |    |
|           |   |   | VL1062C0   | PRESSURE REDUCER-FILTER LOCKING FORK   | 1  | PZ   |             |                                      |     |          |                       |                                   |    |          |                                      |                                   |    |          |                                |                                |    |    |
| VM1054A0  | H7.8 PRESSURE REDUCER RING NUT          | 1   | PZ         |  |  |      |             |                                      |     |          |                       |                                   |    |          |                                      |                                   |    |          |                                |                                |    |    |
| KVL0014B  | EUR 2017 MIND.MAPS PRESSURE REDUCER KIT | <table border="1"> <thead> <tr> <th>Code</th> <th>Description</th> <th>Qty</th> <th>UOM</th> </tr> </thead> <tbody> <tr> <td>RC1372A0</td> <td>Ø10M-1/4 M CIL. STRAIGHT FITTING</td> <td>1</td> <td>PZ</td> </tr> <tr> <td>RC1396A0</td> <td>JG D10-1/4 STRAIGHT END FITTING</td> <td>1</td> <td>PZ</td> </tr> <tr> <td>VL1014B1</td> <td>PRESSURE REDUCER WITH DISTRIBUTOR</td> <td>1</td> <td>PZ</td> </tr> <tr> <td>VM1054A0</td> <td>H7.8 PRESSURE REDUCER RING NUT</td> <td>1</td> <td>PZ</td> </tr> </tbody> </table> | Code       | Description                            | Qty  | UOM  | RC1372A0    | Ø10M-1/4 M CIL. STRAIGHT FITTING     | 1   | PZ       | RC1396A0              | JG D10-1/4 STRAIGHT END FITTING   | 1  | PZ       | VL1014B1                             | PRESSURE REDUCER WITH DISTRIBUTOR | 1  | PZ       | VM1054A0                       | H7.8 PRESSURE REDUCER RING NUT | 1  | PZ |
| Code      | Description                             | Qty   | UOM        |  |  |      |             |                                      |     |          |                       |                                   |    |          |                                      |                                   |    |          |                                |                                |    |    |
| RC1372A0  | Ø10M-1/4 M CIL. STRAIGHT FITTING        | 1   | PZ         |  |  |      |             |                                      |     |          |                       |                                   |    |          |                                      |                                   |    |          |                                |                                |    |    |
| RC1396A0  | JG D10-1/4 STRAIGHT END FITTING         | 1   | PZ         |  |  |      |             |                                      |     |          |                       |                                   |    |          |                                      |                                   |    |          |                                |                                |    |    |
| VL1014B1  | PRESSURE REDUCER WITH DISTRIBUTOR       | 1   | PZ         |  |  |      |             |                                      |     |          |                       |                                   |    |          |                                      |                                   |    |          |                                |                                |    |    |
| VM1054A0  | H7.8 PRESSURE REDUCER RING NUT          | 1   | PZ         |  |  |      |             |                                      |     |          |                       |                                   |    |          |                                      |                                   |    |          |                                |                                |    |    |
| KVL0014A  | EUR MIND.MAPS PRESSURE REDUCER KIT      | <table border="1"> <thead> <tr> <th>Code</th> <th>Description</th> <th>Qty</th> <th>UOM</th> </tr> </thead> <tbody> <tr> <td>RC1372A0</td> <td>Ø10M-1/4 M CIL. STRAIGHT FITTING</td> <td>2</td> <td>PZ</td> </tr> <tr> <td>VL1014B1</td> <td>PRESSURE REDUCER WITH DISTRIBUTOR</td> <td>1</td> <td>PZ</td> </tr> <tr> <td>VM1054A0</td> <td>H7.8 PRESSURE REDUCER RING NUT</td> <td>1</td> <td>PZ</td> </tr> </tbody> </table>  | Code       | Description                            | Qty  | UOM  | RC1372A0    | Ø10M-1/4 M CIL. STRAIGHT FITTING     | 2   | PZ       | VL1014B1              | PRESSURE REDUCER WITH DISTRIBUTOR | 1  | PZ       | VM1054A0                             | H7.8 PRESSURE REDUCER RING NUT    | 1  | PZ       |                                |                                |    |    |
| Code      | Description                             | Qty   | UOM        |  |  |      |             |                                      |     |          |                       |                                   |    |          |                                      |                                   |    |          |                                |                                |    |    |
| RC1372A0  | Ø10M-1/4 M CIL. STRAIGHT FITTING        | 2   | PZ         |  |  |      |             |                                      |     |          |                       |                                   |    |          |                                      |                                   |    |          |                                |                                |    |    |
| VL1014B1  | PRESSURE REDUCER WITH DISTRIBUTOR       | 1   | PZ         |  |  |      |             |                                      |     |          |                       |                                   |    |          |                                      |                                   |    |          |                                |                                |    |    |
| VM1054A0  | H7.8 PRESSURE REDUCER RING NUT          | 1   | PZ         |  |  |      |             |                                      |     |          |                       |                                   |    |          |                                      |                                   |    |          |                                |                                |    |    |
| KVL0010A  | S.4 - 5 WATER PRESSURE REDUCER KIT      | <table border="1"> <thead> <tr> <th>Code</th> <th>Description</th> <th>Qty</th> <th>UOM</th> </tr> </thead> <tbody> <tr> <td>EL1210A0</td> <td>D8-BSP1/4 JG STRAIGHT END CONNECTION</td> <td>2</td> <td>PZ</td> </tr> <tr> <td>VL1014B1</td> <td>PRESSURE REDUCER WITH DISTRIBUTOR</td> <td>1</td> <td>PZ</td> </tr> </tbody> </table>  | Code       | Description                            | Qty  | UOM  | EL1210A0    | D8-BSP1/4 JG STRAIGHT END CONNECTION | 2   | PZ       | VL1014B1              | PRESSURE REDUCER WITH DISTRIBUTOR | 1  | PZ       |                                      |                                   |    |          |                                |                                |    |    |
| Code      | Description                             | Qty   | UOM        |  |  |      |             |                                      |     |          |                       |                                   |    |          |                                      |                                   |    |          |                                |                                |    |    |
| EL1210A0  | D8-BSP1/4 JG STRAIGHT END CONNECTION    | 2   | PZ         |  |  |      |             |                                      |     |          |                       |                                   |    |          |                                      |                                   |    |          |                                |                                |    |    |
| VL1014B1  | PRESSURE REDUCER WITH DISTRIBUTOR       | 1   | PZ         |  |  |      |             |                                      |     |          |                       |                                   |    |          |                                      |                                   |    |          |                                |                                |    |    |

| COMPONENT |  |   | SPARE PART |  |   |      |             |     |     |          |  |       |    |          |   |   |    |          |  |   |    |          |   |   |    |
|-----------|--|---|------------|--|---|------|-------------|-----|-----|----------|--|-------|----|----------|---|---|----|----------|--|---|----|----------|---|---|----|
| Code      | Description                                    | Image   | Code       | Description                                      | Components list   |      |             |     |     |          |  |       |    |          |   |   |    |          |  |   |    |          |   |   |    |
| RC1396A   | JG D10-1/4<br>STRAIGHT END<br>FITTING          |    | KVL0014B   | EUR 2017<br>MIND.MAPS<br>PRESSURE<br>REDUCER KIT | <table border="1"> <thead> <tr> <th>Code</th> <th>Description</th> <th>Qty</th> <th>UOM</th> </tr> </thead> <tbody> <tr> <td>RC1372A0</td> <td>Ø10M-1/4 M<br/>CIL. STRAIGHT<br/>FITTING</td> <td>1</td> <td>PZ</td> </tr> <tr> <td>RC1396A0</td> <td>JG D10-1/4<br/>STRAIGHT<br/>END FITTING</td> <td>1</td> <td>PZ</td> </tr> <tr> <td>VL1014B1</td> <td>PRESSURE<br/>REDUCER<br/>WITH<br/>DISTRIBUTOR</td> <td>1</td> <td>PZ</td> </tr> <tr> <td>VM1054A0</td> <td>H7.8<br/>PRESSURE<br/>REDUCER<br/>RING NUT</td> <td>1</td> <td>PZ</td> </tr> </tbody> </table> | Code | Description | Qty | UOM | RC1372A0 | Ø10M-1/4 M<br>CIL. STRAIGHT<br>FITTING | 1     | PZ | RC1396A0 | JG D10-1/4<br>STRAIGHT<br>END FITTING       | 1 | PZ | VL1014B1 | PRESSURE<br>REDUCER<br>WITH<br>DISTRIBUTOR   | 1 | PZ | VM1054A0 | H7.8<br>PRESSURE<br>REDUCER<br>RING NUT | 1 | PZ |
| Code      | Description                                    | Qty   | UOM        |  |   |      |             |     |     |          |  |       |    |          |   |   |    |          |  |   |    |          |   |   |    |
| RC1372A0  | Ø10M-1/4 M<br>CIL. STRAIGHT<br>FITTING         | 1   | PZ         |  |   |      |             |     |     |          |  |       |    |          |   |   |    |          |  |   |    |          |   |   |    |
| RC1396A0  | JG D10-1/4<br>STRAIGHT<br>END FITTING          | 1   | PZ         |  |   |      |             |     |     |          |  |       |    |          |   |   |    |          |  |   |    |          |   |   |    |
| VL1014B1  | PRESSURE<br>REDUCER<br>WITH<br>DISTRIBUTOR     | 1   | PZ         |  |   |      |             |     |     |          |  |       |    |          |   |   |    |          |  |   |    |          |   |   |    |
| VM1054A0  | H7.8<br>PRESSURE<br>REDUCER<br>RING NUT        | 1   | PZ         |  |   |      |             |     |     |          |  |       |    |          |   |   |    |          |  |   |    |          |   |   |    |
| VL1063A   | HOSE D8 TANG D10                               |   | KVL1063A   | Ø8 PIPE<br>HOLDER+Ø10 JG<br>TERMINAL 10PCS KI    | <table border="1"> <thead> <tr> <th>Code</th> <th>Description</th> <th>Qty</th> <th>UOM</th> </tr> </thead> <tbody> <tr> <td>VL1063A0</td> <td>HOSE D8<br/>TANG D10</td> <td>10</td> <td>PZ</td> </tr> </tbody> </table>  | Code | Description | Qty | UOM | VL1063A0 | HOSE D8<br>TANG D10                    | 10    | PZ |          |   |   |    |          |  |   |    |          |   |   |    |
| Code      | Description                                    | Qty   | UOM        |  |   |      |             |     |     |          |  |       |    |          |   |   |    |          |  |   |    |          |   |   |    |
| VL1063A0  | HOSE D8<br>TANG D10                            | 10  | PZ         |  |   |      |             |     |     |          |  |       |    |          |   |   |    |          |  |   |    |          |   |   |    |
| RC1046A   | D10-16 H9 ST STEEL<br>HOSE CLAMP               |  | KTB2237A   | 1,5M D10 TB2243A<br>CONNECTION PIPE<br>KIT       | <table border="1"> <thead> <tr> <th>Code</th> <th>Description</th> <th>Qty</th> <th>UOM</th> </tr> </thead> <tbody> <tr> <td>TB2243A0</td> <td>Ø10 PET PIPE</td> <td>1.500</td> <td>M</td> </tr> </tbody> </table>  | Code | Description | Qty | UOM | TB2243A0 | Ø10 PET PIPE                           | 1.500 | M  |          |   |   |    |          |  |   |    |          |   |   |    |
| Code      | Description                                    | Qty   | UOM        |  |   |      |             |     |     |          |  |       |    |          |   |   |    |          |  |   |    |          |   |   |    |
| TB2243A0  | Ø10 PET PIPE                                   | 1.500   | M          |  |   |      |             |     |     |          |  |       |    |          |   |   |    |          |  |   |    |          |   |   |    |
| VL1096A   | T SHAPED FITTING<br>2X RUBBER<br>HOLDER D6-D10 |  | KVL1096A   | T - SHAPED<br>FIT-D6-D10 HOLD-2<br>MAGNETS KIT   | <table border="1"> <thead> <tr> <th>Code</th> <th>Description</th> <th>Qty</th> <th>UOM</th> </tr> </thead> <tbody> <tr> <td>RC1018A0</td> <td>ZINC PLATED<br/>D12 ELASTIC<br/>CLAMP</td> <td>2</td> <td>PZ</td> </tr> <tr> <td>VL1086A0</td> <td>LIMESCALE<br/>REMOVER<br/>NEODYMIUM<br/>MAGNET</td> <td>2</td> <td>PZ</td> </tr> <tr> <td>VL1096A1</td> <td>2PCS<br/>T-SHAPED<br/>FIT-D6-D10<br/>HOLD-MAGNE</td> <td>1</td> <td>PZ</td> </tr> </tbody> </table>   | Code | Description | Qty | UOM | RC1018A0 | ZINC PLATED<br>D12 ELASTIC<br>CLAMP    | 2     | PZ | VL1086A0 | LIMESCALE<br>REMOVER<br>NEODYMIUM<br>MAGNET | 2 | PZ | VL1096A1 | 2PCS<br>T-SHAPED<br>FIT-D6-D10<br>HOLD-MAGNE | 1 | PZ |          |   |   |    |
| Code      | Description                                    | Qty   | UOM        |  |   |      |             |     |     |          |  |       |    |          |   |   |    |          |  |   |    |          |   |   |    |
| RC1018A0  | ZINC PLATED<br>D12 ELASTIC<br>CLAMP            | 2   | PZ         |  |   |      |             |     |     |          |  |       |    |          |   |   |    |          |  |   |    |          |   |   |    |
| VL1086A0  | LIMESCALE<br>REMOVER<br>NEODYMIUM<br>MAGNET    | 2   | PZ         |  |   |      |             |     |     |          |  |       |    |          |   |   |    |          |  |   |    |          |   |   |    |
| VL1096A1  | 2PCS<br>T-SHAPED<br>FIT-D6-D10<br>HOLD-MAGNE   | 1   | PZ         |  |   |      |             |     |     |          |  |       |    |          |   |   |    |          |  |   |    |          |   |   |    |

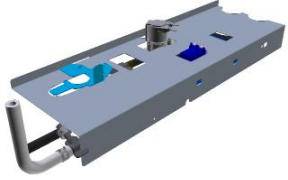
| COMPONENT |  |   | SPARE PART |  |  |      |             |     |     |          |   |    |    |
|-----------|--|---|------------|--|--|------|-------------|-----|-----|----------|---|----|----|
| Code      | Description                                  | Image   | Code       | Description                                    | Components list  |      |             |     |     |          |   |    |    |
| 0F1507B   | XEVC-2011 SERIES<br>LOWER BACK               |    |            |  |  |      |             |     |     |          |   |    |    |
| VL1047A   | HOSE D6 TANG D8                              |    |            |  |  |      |             |     |     |          |   |    |    |
| VL1095A   | FITTING M-M<br>RUBBER HOLDER<br>D7,8-D10     |  | KVL1095A   | STRAIGHT<br>CONNECT-HOLDER<br>D7-D10 10PCS KIT | <table border="1"> <thead> <tr> <th>Code</th> <th>Description</th> <th>Qty</th> <th>UOM</th> </tr> </thead> <tbody> <tr> <td>VL1095A0</td> <td>FITTING M-M<br/>RUBBER<br/>HOLDER<br/>D7,8-D10</td> <td>10</td> <td>PZ</td> </tr> </tbody> </table> | Code | Description | Qty | UOM | VL1095A0 | FITTING M-M<br>RUBBER<br>HOLDER<br>D7,8-D10 | 10 | PZ |
| Code      | Description                                  | Qty   | UOM        |  |  |      |             |     |     |          |   |    |    |
| VL1095A0  | FITTING M-M<br>RUBBER<br>HOLDER<br>D7,8-D10  | 10  | PZ         |  |  |      |             |     |     |          |   |    |    |
| 0H7515A   | XEVC-2011-E1R<br>DOUBLE WASHING<br>SYS PLATE |  | 0H7515A0   | XEVC-2011-E1R<br>DOUBLE WASHING<br>SYS PLATE   |  |      |             |     |     |          |   |    |    |
| VL1127A   | T SHAPED BARBED<br>FITTING D=6               |  | KVL1127A   | 6MM BARBED<br>T-SHAPED FITTING<br>10 PCS KIT   | <table border="1"> <thead> <tr> <th>Code</th> <th>Description</th> <th>Qty</th> <th>UOM</th> </tr> </thead> <tbody> <tr> <td>VL1127A1</td> <td>6MM BARBED<br/>T-SHAPED<br/>FITTING</td> <td>10</td> <td>PZ</td> </tr> </tbody> </table>            | Code | Description | Qty | UOM | VL1127A1 | 6MM BARBED<br>T-SHAPED<br>FITTING           | 10 | PZ |
| Code      | Description                                  | Qty   | UOM        |  |  |      |             |     |     |          |   |    |    |
| VL1127A1  | 6MM BARBED<br>T-SHAPED<br>FITTING            | 10  | PZ         |  |  |      |             |     |     |          |   |    |    |

| COMPONENT |  |   | SPARE PART |  |  |      |             |     |     |          |  |    |    |          |   |   |    |          |                             |   |    |          |                    |   |    |          |                                    |       |   |          |                                      |   |    |          |                   |   |    |          |  |   |    |          |  |   |    |          |  |   |    |          |                             |   |    |          |                      |   |    |
|-----------|--|---|------------|--|--|------|-------------|-----|-----|----------|--|----|----|----------|---|---|----|----------|-----------------------------|---|----|----------|--------------------|---|----|----------|------------------------------------|-------|---|----------|--------------------------------------|---|----|----------|-------------------|---|----|----------|--|---|----|----------|--|---|----|----------|--|---|----|----------|-----------------------------|---|----|----------|----------------------|---|----|
| Code      | Description  | Image   | Code       | Description                                    | Components list  |      |             |     |     |          |  |    |    |          |   |   |    |          |                             |   |    |          |                    |   |    |          |                                    |       |   |          |                                      |   |    |          |                   |   |    |          |  |   |    |          |  |   |    |          |  |   |    |          |                             |   |    |          |                      |   |    |
| VL1106B   |  |    | KVL1106A   | EUR 1 ROTOR ARM<br>ONE CLEANING<br>SYSTEM KIT  | <table border="1"> <thead> <tr> <th>Code</th> <th>Description</th> <th>Qty</th> <th>UOM</th> </tr> </thead> <tbody> <tr> <td>0H7819A0</td> <td>ONE<br/>WASHING SYS<br/>SUPPORT<br/>WITH STEAM<br/>VALVE</td> <td>1</td> <td>PZ</td> </tr> <tr> <td>EL1436A0</td> <td>H2O<br/>SOLENOID JG<br/>D8 CHECK<br/>VALVE</td> <td>1</td> <td>PZ</td> </tr> <tr> <td>GN1526A0</td> <td>INT. D.=6.9<br/>TH=1.8 O-RIN</td> <td>1</td> <td>PZ</td> </tr> <tr> <td>RC1242A0</td> <td>D=10 CLOSED<br/>CAP</td> <td>2</td> <td>PZ</td> </tr> <tr> <td>TB2820A0</td> <td>PIPE EPDM<br/>FOR WASHING<br/>SYSTEM</td> <td>1.420</td> <td>M</td> </tr> <tr> <td>V11220A1</td> <td>4,2X12 TCB<br/>SELF-TAPPIN<br/>G SCREW</td> <td>1</td> <td>PZ</td> </tr> <tr> <td>VL1019A0</td> <td>VIBRATION<br/>PUMP</td> <td>1</td> <td>PZ</td> </tr> <tr> <td>VL1053B0</td> <td>ONE<br/>WASHING SYS<br/>EXT<br/>DISTRIBUTOR</td> <td>1</td> <td>PZ</td> </tr> <tr> <td>VL1054B0</td> <td>ONE<br/>WASHING SYS<br/>INLET<br/>DISTRIBUTOR</td> <td>1</td> <td>PZ</td> </tr> <tr> <td>VL1102A1</td> <td>DETERGENT<br/>LINE FILTER +<br/>BARBED VNR<br/>6 MM</td> <td>1</td> <td>PZ</td> </tr> <tr> <td>VL1128A0</td> <td>BARBED<br/>CHECK VALVE<br/>D6</td> <td>1</td> <td>PZ</td> </tr> <tr> <td>VM2172A0</td> <td>PUMP<br/>LOCKING CLIP</td> <td>1</td> <td>PZ</td> </tr> </tbody> </table> | Code | Description | Qty | UOM | 0H7819A0 | ONE<br>WASHING SYS<br>SUPPORT<br>WITH STEAM<br>VALVE | 1  | PZ | EL1436A0 | H2O<br>SOLENOID JG<br>D8 CHECK<br>VALVE | 1 | PZ | GN1526A0 | INT. D.=6.9<br>TH=1.8 O-RIN | 1 | PZ | RC1242A0 | D=10 CLOSED<br>CAP | 2 | PZ | TB2820A0 | PIPE EPDM<br>FOR WASHING<br>SYSTEM | 1.420 | M | V11220A1 | 4,2X12 TCB<br>SELF-TAPPIN<br>G SCREW | 1 | PZ | VL1019A0 | VIBRATION<br>PUMP | 1 | PZ | VL1053B0 | ONE<br>WASHING SYS<br>EXT<br>DISTRIBUTOR | 1 | PZ | VL1054B0 | ONE<br>WASHING SYS<br>INLET<br>DISTRIBUTOR | 1 | PZ | VL1102A1 | DETERGENT<br>LINE FILTER +<br>BARBED VNR<br>6 MM | 1 | PZ | VL1128A0 | BARBED<br>CHECK VALVE<br>D6 | 1 | PZ | VM2172A0 | PUMP<br>LOCKING CLIP | 1 | PZ |
| Code      | Description  | Qty   | UOM        |  |  |      |             |     |     |          |  |    |    |          |   |   |    |          |                             |   |    |          |                    |   |    |          |                                    |       |   |          |                                      |   |    |          |                   |   |    |          |  |   |    |          |  |   |    |          |  |   |    |          |                             |   |    |          |                      |   |    |
| 0H7819A0  | ONE<br>WASHING SYS<br>SUPPORT<br>WITH STEAM<br>VALVE | 1   | PZ         |  |  |      |             |     |     |          |  |    |    |          |   |   |    |          |                             |   |    |          |                    |   |    |          |                                    |       |   |          |                                      |   |    |          |                   |   |    |          |  |   |    |          |  |   |    |          |  |   |    |          |                             |   |    |          |                      |   |    |
| EL1436A0  | H2O<br>SOLENOID JG<br>D8 CHECK<br>VALVE              | 1   | PZ         |  |  |      |             |     |     |          |  |    |    |          |   |   |    |          |                             |   |    |          |                    |   |    |          |                                    |       |   |          |                                      |   |    |          |                   |   |    |          |  |   |    |          |  |   |    |          |  |   |    |          |                             |   |    |          |                      |   |    |
| GN1526A0  | INT. D.=6.9<br>TH=1.8 O-RIN                          | 1   | PZ         |  |  |      |             |     |     |          |  |    |    |          |   |   |    |          |                             |   |    |          |                    |   |    |          |                                    |       |   |          |                                      |   |    |          |                   |   |    |          |  |   |    |          |  |   |    |          |  |   |    |          |                             |   |    |          |                      |   |    |
| RC1242A0  | D=10 CLOSED<br>CAP                                   | 2   | PZ         |  |  |      |             |     |     |          |  |    |    |          |   |   |    |          |                             |   |    |          |                    |   |    |          |                                    |       |   |          |                                      |   |    |          |                   |   |    |          |  |   |    |          |  |   |    |          |  |   |    |          |                             |   |    |          |                      |   |    |
| TB2820A0  | PIPE EPDM<br>FOR WASHING<br>SYSTEM                   | 1.420   | M          |  |  |      |             |     |     |          |  |    |    |          |   |   |    |          |                             |   |    |          |                    |   |    |          |                                    |       |   |          |                                      |   |    |          |                   |   |    |          |  |   |    |          |  |   |    |          |  |   |    |          |                             |   |    |          |                      |   |    |
| V11220A1  | 4,2X12 TCB<br>SELF-TAPPIN<br>G SCREW                 | 1   | PZ         |  |  |      |             |     |     |          |  |    |    |          |   |   |    |          |                             |   |    |          |                    |   |    |          |                                    |       |   |          |                                      |   |    |          |                   |   |    |          |  |   |    |          |  |   |    |          |  |   |    |          |                             |   |    |          |                      |   |    |
| VL1019A0  | VIBRATION<br>PUMP                                    | 1   | PZ         |  |  |      |             |     |     |          |  |    |    |          |   |   |    |          |                             |   |    |          |                    |   |    |          |                                    |       |   |          |                                      |   |    |          |                   |   |    |          |  |   |    |          |  |   |    |          |  |   |    |          |                             |   |    |          |                      |   |    |
| VL1053B0  | ONE<br>WASHING SYS<br>EXT<br>DISTRIBUTOR             | 1   | PZ         |  |  |      |             |     |     |          |  |    |    |          |   |   |    |          |                             |   |    |          |                    |   |    |          |                                    |       |   |          |                                      |   |    |          |                   |   |    |          |  |   |    |          |  |   |    |          |  |   |    |          |                             |   |    |          |                      |   |    |
| VL1054B0  | ONE<br>WASHING SYS<br>INLET<br>DISTRIBUTOR           | 1   | PZ         |  |  |      |             |     |     |          |  |    |    |          |   |   |    |          |                             |   |    |          |                    |   |    |          |                                    |       |   |          |                                      |   |    |          |                   |   |    |          |  |   |    |          |  |   |    |          |  |   |    |          |                             |   |    |          |                      |   |    |
| VL1102A1  | DETERGENT<br>LINE FILTER +<br>BARBED VNR<br>6 MM     | 1   | PZ         |  |  |      |             |     |     |          |  |    |    |          |   |   |    |          |                             |   |    |          |                    |   |    |          |                                    |       |   |          |                                      |   |    |          |                   |   |    |          |  |   |    |          |  |   |    |          |  |   |    |          |                             |   |    |          |                      |   |    |
| VL1128A0  | BARBED<br>CHECK VALVE<br>D6                          | 1   | PZ         |  |  |      |             |     |     |          |  |    |    |          |   |   |    |          |                             |   |    |          |                    |   |    |          |                                    |       |   |          |                                      |   |    |          |                   |   |    |          |  |   |    |          |  |   |    |          |  |   |    |          |                             |   |    |          |                      |   |    |
| VM2172A0  | PUMP<br>LOCKING CLIP                                 | 1   | PZ         |  |  |      |             |     |     |          |  |    |    |          |   |   |    |          |                             |   |    |          |                    |   |    |          |                                    |       |   |          |                                      |   |    |          |                   |   |    |          |  |   |    |          |  |   |    |          |  |   |    |          |                             |   |    |          |                      |   |    |
| RC1019A   | D=10 ELASTIC CLAM                                    |  | KRC1019A   | Ø10 ZINC PLATED<br>ELASTIC CLAMP 15<br>PCS KIT | <table border="1"> <thead> <tr> <th>Code</th> <th>Description</th> <th>Qty</th> <th>UOM</th> </tr> </thead> <tbody> <tr> <td>RC1019A0</td> <td>D=10 ELASTIC<br/>CLAMP</td> <td>17</td> <td>PZ</td> </tr> </tbody> </table>   | Code | Description | Qty | UOM | RC1019A0 | D=10 ELASTIC<br>CLAMP                                | 17 | PZ |          |   |   |    |          |                             |   |    |          |                    |   |    |          |                                    |       |   |          |                                      |   |    |          |                   |   |    |          |  |   |    |          |  |   |    |          |  |   |    |          |                             |   |    |          |                      |   |    |
| Code      | Description  | Qty   | UOM        |  |  |      |             |     |     |          |  |    |    |          |   |   |    |          |                             |   |    |          |                    |   |    |          |                                    |       |   |          |                                      |   |    |          |                   |   |    |          |  |   |    |          |  |   |    |          |  |   |    |          |                             |   |    |          |                      |   |    |
| RC1019A0  | D=10 ELASTIC<br>CLAMP                                | 17  | PZ         |  |  |      |             |     |     |          |  |    |    |          |   |   |    |          |                             |   |    |          |                    |   |    |          |                                    |       |   |          |                                      |   |    |          |                   |   |    |          |  |   |    |          |  |   |    |          |  |   |    |          |                             |   |    |          |                      |   |    |



| COMPONENT |                                     |   | SPARE PART |  |  |      |             |     |     |          |                              |       |    |
|-----------|-------------------------------------|---|------------|--|--|------|-------------|-----|-----|----------|------------------------------|-------|----|
| Code      | Description                         | Image   | Code       | Description                            | Components list  |      |             |     |     |          |                              |       |    |
| TB3007A   | TB2820A-DETERGENT ONE COIL          |    | KTB3007A   | MIND.MAPS ONE DETERGENT PIPE COIL KIT  | <table border="1"> <thead> <tr> <th>Code</th> <th>Description</th> <th>Qty</th> <th>UOM</th> </tr> </thead> <tbody> <tr> <td>TB2820A0</td> <td>PIPE EPDM FOR WASHING SYSTEM</td> <td>0.550</td> <td>M</td> </tr> </tbody> </table> | Code | Description | Qty | UOM | TB2820A0 | PIPE EPDM FOR WASHING SYSTEM | 0.550 | M  |
| Code      | Description                         | Qty   | UOM        |  |  |      |             |     |     |          |                              |       |    |
| TB2820A0  | PIPE EPDM FOR WASHING SYSTEM        | 0.550   | M          |  |  |      |             |     |     |          |                              |       |    |
| TB3225B   | TB2820A-TANK-WASHING SYS CONNECTION |    | TB3225B0   | TB2820A-TANK-WASHING SYS CONNECTION    |  |      |             |     |     |          |                              |       |    |
| VL1127A   | T SHAPED BARBED FITTING D=6         |  | KVL1127A   | 6MM BARBED T-SHAPED FITTING 10 PCS KIT | <table border="1"> <thead> <tr> <th>Code</th> <th>Description</th> <th>Qty</th> <th>UOM</th> </tr> </thead> <tbody> <tr> <td>VL1127A1</td> <td>6MM BARBED T-SHAPED FITTING</td> <td>10</td> <td>PZ</td> </tr> </tbody> </table>    | Code | Description | Qty | UOM | VL1127A1 | 6MM BARBED T-SHAPED FITTING  | 10    | PZ |
| Code      | Description                         | Qty   | UOM        |  |  |      |             |     |     |          |                              |       |    |
| VL1127A1  | 6MM BARBED T-SHAPED FITTING         | 10  | PZ         |  |  |      |             |     |     |          |                              |       |    |
| VL1047A   | HOSE D6 TANG D8                     |  |            |  |  |      |             |     |     |          |                              |       |    |
| TB3254A   | TB3132A-USA H2O STEAM INLET PIPE    |  | TB3254A0   | TB3132A-USA H2O STEAM INLET PIPE       |  |      |             |     |     |          |                              |       |    |

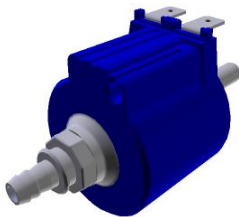

| COMPONENT |   |   | SPARE PART |  |   |      |             |     |     |          |                           |   |    |          |                                    |   |    |          |                                |   |    |          |                          |   |    |          |                    |    |    |          |                 |   |    |          |                                   |   |    |          |                              |       |   |          |                                |   |    |          |                |   |    |          |                                 |   |    |          |                                   |   |    |          |   |   |    |          |                       |   |    |          |                   |   |    |          |                                      |  |      |             |     |     |          |                               |   |    |
|-----------|---|---|------------|--|---|------|-------------|-----|-----|----------|---------------------------|---|----|----------|------------------------------------|---|----|----------|--------------------------------|---|----|----------|--------------------------|---|----|----------|--------------------|----|----|----------|-----------------|---|----|----------|-----------------------------------|---|----|----------|------------------------------|-------|---|----------|--------------------------------|---|----|----------|----------------|---|----|----------|---------------------------------|---|----|----------|-----------------------------------|---|----|----------|---|---|----|----------|-----------------------|---|----|----------|-------------------|---|----|----------|--------------------------------------|--|------|-------------|-----|-----|----------|-------------------------------|---|----|
| Code      | Description                             | Image   | Code       | Description                            | Components list   |      |             |     |     |          |                           |   |    |          |                                    |   |    |          |                                |   |    |          |                          |   |    |          |                    |    |    |          |                 |   |    |          |                                   |   |    |          |                              |       |   |          |                                |   |    |          |                |   |    |          |                                 |   |    |          |                                   |   |    |          |   |   |    |          |                       |   |    |          |                   |   |    |          |                                      |  |      |             |     |     |          |                               |   |    |
| VL1019A   | VIBRATION PUMP                          |  | KVL1121A   | EUR MIND.MAPS HOOD CLEANING SYSTEM KIT | <table border="1"> <thead> <tr> <th>Code</th> <th>Description</th> <th>Qty</th> <th>UOM</th> </tr> </thead> <tbody> <tr> <td>0H7368A0</td> <td>S6 HOOD WATER SYSTEM PLAT</td> <td>1</td> <td>PZ</td> </tr> <tr> <td>EL1424A0</td> <td>D8 CONNECTION WATER SOLENOID VALVE</td> <td>1</td> <td>PZ</td> </tr> <tr> <td>EL1436A0</td> <td>H2O SOLENOID JG D8 CHECK VALVE</td> <td>1</td> <td>PZ</td> </tr> <tr> <td>GN1526A0</td> <td>INT. D.=6.9 TH=1.8 O-RIN</td> <td>1</td> <td>PZ</td> </tr> <tr> <td>RC1019A0</td> <td>D=10 ELASTIC CLAMP</td> <td>12</td> <td>PZ</td> </tr> <tr> <td>RC1242A0</td> <td>D=10 CLOSED CAP</td> <td>2</td> <td>PZ</td> </tr> <tr> <td>RC1408A0</td> <td>DOUBLE WIRE SPRING CLAMP D10.8 ZN</td> <td>2</td> <td>PZ</td> </tr> <tr> <td>TB2820A0</td> <td>PIPE EPDM FOR WASHING SYSTEM</td> <td>2.200</td> <td>M</td> </tr> <tr> <td>VH1220A1</td> <td>4,2X12 TCB SELF-TAPPIN G SCREW</td> <td>5</td> <td>PZ</td> </tr> <tr> <td>VL1019A0</td> <td>VIBRATION PUMP</td> <td>1</td> <td>PZ</td> </tr> <tr> <td>VL1053B0</td> <td>ONE WASHING SYS EXT DISTRIBUTOR</td> <td>1</td> <td>PZ</td> </tr> <tr> <td>VL1054B0</td> <td>ONE WASHING SYS INLET DISTRIBUTOR</td> <td>1</td> <td>PZ</td> </tr> <tr> <td>VL1102A1</td> <td>DETERGENT LINE FILTER + BARBED VNR 6 MM</td> <td>1</td> <td>PZ</td> </tr> <tr> <td>VL1128A0</td> <td>BARBED CHECK VALVE D6</td> <td>1</td> <td>PZ</td> </tr> <tr> <td>VM2172A0</td> <td>PUMP LOCKING CLIP</td> <td>1</td> <td>PZ</td> </tr> </tbody> </table> | Code | Description | Qty | UOM | 0H7368A0 | S6 HOOD WATER SYSTEM PLAT | 1 | PZ | EL1424A0 | D8 CONNECTION WATER SOLENOID VALVE | 1 | PZ | EL1436A0 | H2O SOLENOID JG D8 CHECK VALVE | 1 | PZ | GN1526A0 | INT. D.=6.9 TH=1.8 O-RIN | 1 | PZ | RC1019A0 | D=10 ELASTIC CLAMP | 12 | PZ | RC1242A0 | D=10 CLOSED CAP | 2 | PZ | RC1408A0 | DOUBLE WIRE SPRING CLAMP D10.8 ZN | 2 | PZ | TB2820A0 | PIPE EPDM FOR WASHING SYSTEM | 2.200 | M | VH1220A1 | 4,2X12 TCB SELF-TAPPIN G SCREW | 5 | PZ | VL1019A0 | VIBRATION PUMP | 1 | PZ | VL1053B0 | ONE WASHING SYS EXT DISTRIBUTOR | 1 | PZ | VL1054B0 | ONE WASHING SYS INLET DISTRIBUTOR | 1 | PZ | VL1102A1 | DETERGENT LINE FILTER + BARBED VNR 6 MM | 1 | PZ | VL1128A0 | BARBED CHECK VALVE D6 | 1 | PZ | VM2172A0 | PUMP LOCKING CLIP | 1 | PZ | KVL1120A | USA COMPACT PLUS CLEANING SYSTEM KIT | <table border="1"> <thead> <tr> <th>Code</th> <th>Description</th> <th>Qty</th> <th>UOM</th> </tr> </thead> <tbody> <tr> <td>0H7553D0</td> <td>XECC PLUS WASHING SYSTEM PLAT</td> <td>1</td> <td>PZ</td> </tr> </tbody> </table> | Code | Description | Qty | UOM | 0H7553D0 | XECC PLUS WASHING SYSTEM PLAT | 1 | PZ |
|           |   |   | Code       | Description                            | Qty   | UOM  |             |     |     |          |                           |   |    |          |                                    |   |    |          |                                |   |    |          |                          |   |    |          |                    |    |    |          |                 |   |    |          |                                   |   |    |          |                              |       |   |          |                                |   |    |          |                |   |    |          |                                 |   |    |          |                                   |   |    |          |   |   |    |          |                       |   |    |          |                   |   |    |          |                                      |  |      |             |     |     |          |                               |   |    |
| 0H7368A0  | S6 HOOD WATER SYSTEM PLAT               | 1   | PZ         |  |   |      |             |     |     |          |                           |   |    |          |                                    |   |    |          |                                |   |    |          |                          |   |    |          |                    |    |    |          |                 |   |    |          |                                   |   |    |          |                              |       |   |          |                                |   |    |          |                |   |    |          |                                 |   |    |          |                                   |   |    |          |   |   |    |          |                       |   |    |          |                   |   |    |          |                                      |  |      |             |     |     |          |                               |   |    |
| EL1424A0  | D8 CONNECTION WATER SOLENOID VALVE      | 1   | PZ         |  |   |      |             |     |     |          |                           |   |    |          |                                    |   |    |          |                                |   |    |          |                          |   |    |          |                    |    |    |          |                 |   |    |          |                                   |   |    |          |                              |       |   |          |                                |   |    |          |                |   |    |          |                                 |   |    |          |                                   |   |    |          |   |   |    |          |                       |   |    |          |                   |   |    |          |                                      |  |      |             |     |     |          |                               |   |    |
| EL1436A0  | H2O SOLENOID JG D8 CHECK VALVE          | 1   | PZ         |  |   |      |             |     |     |          |                           |   |    |          |                                    |   |    |          |                                |   |    |          |                          |   |    |          |                    |    |    |          |                 |   |    |          |                                   |   |    |          |                              |       |   |          |                                |   |    |          |                |   |    |          |                                 |   |    |          |                                   |   |    |          |   |   |    |          |                       |   |    |          |                   |   |    |          |                                      |  |      |             |     |     |          |                               |   |    |
| GN1526A0  | INT. D.=6.9 TH=1.8 O-RIN                | 1   | PZ         |  |   |      |             |     |     |          |                           |   |    |          |                                    |   |    |          |                                |   |    |          |                          |   |    |          |                    |    |    |          |                 |   |    |          |                                   |   |    |          |                              |       |   |          |                                |   |    |          |                |   |    |          |                                 |   |    |          |                                   |   |    |          |   |   |    |          |                       |   |    |          |                   |   |    |          |                                      |  |      |             |     |     |          |                               |   |    |
| RC1019A0  | D=10 ELASTIC CLAMP                      | 12  | PZ         |  |   |      |             |     |     |          |                           |   |    |          |                                    |   |    |          |                                |   |    |          |                          |   |    |          |                    |    |    |          |                 |   |    |          |                                   |   |    |          |                              |       |   |          |                                |   |    |          |                |   |    |          |                                 |   |    |          |                                   |   |    |          |   |   |    |          |                       |   |    |          |                   |   |    |          |                                      |  |      |             |     |     |          |                               |   |    |
| RC1242A0  | D=10 CLOSED CAP                         | 2   | PZ         |  |   |      |             |     |     |          |                           |   |    |          |                                    |   |    |          |                                |   |    |          |                          |   |    |          |                    |    |    |          |                 |   |    |          |                                   |   |    |          |                              |       |   |          |                                |   |    |          |                |   |    |          |                                 |   |    |          |                                   |   |    |          |   |   |    |          |                       |   |    |          |                   |   |    |          |                                      |  |      |             |     |     |          |                               |   |    |
| RC1408A0  | DOUBLE WIRE SPRING CLAMP D10.8 ZN       | 2   | PZ         |  |   |      |             |     |     |          |                           |   |    |          |                                    |   |    |          |                                |   |    |          |                          |   |    |          |                    |    |    |          |                 |   |    |          |                                   |   |    |          |                              |       |   |          |                                |   |    |          |                |   |    |          |                                 |   |    |          |                                   |   |    |          |   |   |    |          |                       |   |    |          |                   |   |    |          |                                      |  |      |             |     |     |          |                               |   |    |
| TB2820A0  | PIPE EPDM FOR WASHING SYSTEM            | 2.200   | M          |  |   |      |             |     |     |          |                           |   |    |          |                                    |   |    |          |                                |   |    |          |                          |   |    |          |                    |    |    |          |                 |   |    |          |                                   |   |    |          |                              |       |   |          |                                |   |    |          |                |   |    |          |                                 |   |    |          |                                   |   |    |          |   |   |    |          |                       |   |    |          |                   |   |    |          |                                      |  |      |             |     |     |          |                               |   |    |
| VH1220A1  | 4,2X12 TCB SELF-TAPPIN G SCREW          | 5   | PZ         |  |   |      |             |     |     |          |                           |   |    |          |                                    |   |    |          |                                |   |    |          |                          |   |    |          |                    |    |    |          |                 |   |    |          |                                   |   |    |          |                              |       |   |          |                                |   |    |          |                |   |    |          |                                 |   |    |          |                                   |   |    |          |   |   |    |          |                       |   |    |          |                   |   |    |          |                                      |  |      |             |     |     |          |                               |   |    |
| VL1019A0  | VIBRATION PUMP                          | 1   | PZ         |  |   |      |             |     |     |          |                           |   |    |          |                                    |   |    |          |                                |   |    |          |                          |   |    |          |                    |    |    |          |                 |   |    |          |                                   |   |    |          |                              |       |   |          |                                |   |    |          |                |   |    |          |                                 |   |    |          |                                   |   |    |          |   |   |    |          |                       |   |    |          |                   |   |    |          |                                      |  |      |             |     |     |          |                               |   |    |
| VL1053B0  | ONE WASHING SYS EXT DISTRIBUTOR         | 1   | PZ         |  |   |      |             |     |     |          |                           |   |    |          |                                    |   |    |          |                                |   |    |          |                          |   |    |          |                    |    |    |          |                 |   |    |          |                                   |   |    |          |                              |       |   |          |                                |   |    |          |                |   |    |          |                                 |   |    |          |                                   |   |    |          |   |   |    |          |                       |   |    |          |                   |   |    |          |                                      |  |      |             |     |     |          |                               |   |    |
| VL1054B0  | ONE WASHING SYS INLET DISTRIBUTOR       | 1   | PZ         |  |   |      |             |     |     |          |                           |   |    |          |                                    |   |    |          |                                |   |    |          |                          |   |    |          |                    |    |    |          |                 |   |    |          |                                   |   |    |          |                              |       |   |          |                                |   |    |          |                |   |    |          |                                 |   |    |          |                                   |   |    |          |   |   |    |          |                       |   |    |          |                   |   |    |          |                                      |  |      |             |     |     |          |                               |   |    |
| VL1102A1  | DETERGENT LINE FILTER + BARBED VNR 6 MM | 1   | PZ         |  |   |      |             |     |     |          |                           |   |    |          |                                    |   |    |          |                                |   |    |          |                          |   |    |          |                    |    |    |          |                 |   |    |          |                                   |   |    |          |                              |       |   |          |                                |   |    |          |                |   |    |          |                                 |   |    |          |                                   |   |    |          |   |   |    |          |                       |   |    |          |                   |   |    |          |                                      |  |      |             |     |     |          |                               |   |    |
| VL1128A0  | BARBED CHECK VALVE D6                   | 1   | PZ         |  |   |      |             |     |     |          |                           |   |    |          |                                    |   |    |          |                                |   |    |          |                          |   |    |          |                    |    |    |          |                 |   |    |          |                                   |   |    |          |                              |       |   |          |                                |   |    |          |                |   |    |          |                                 |   |    |          |                                   |   |    |          |   |   |    |          |                       |   |    |          |                   |   |    |          |                                      |  |      |             |     |     |          |                               |   |    |
| VM2172A0  | PUMP LOCKING CLIP                       | 1   | PZ         |  |   |      |             |     |     |          |                           |   |    |          |                                    |   |    |          |                                |   |    |          |                          |   |    |          |                    |    |    |          |                 |   |    |          |                                   |   |    |          |                              |       |   |          |                                |   |    |          |                |   |    |          |                                 |   |    |          |                                   |   |    |          |   |   |    |          |                       |   |    |          |                   |   |    |          |                                      |  |      |             |     |     |          |                               |   |    |
| Code      | Description                             | Qty   | UOM        |  |   |      |             |     |     |          |                           |   |    |          |                                    |   |    |          |                                |   |    |          |                          |   |    |          |                    |    |    |          |                 |   |    |          |                                   |   |    |          |                              |       |   |          |                                |   |    |          |                |   |    |          |                                 |   |    |          |                                   |   |    |          |   |   |    |          |                       |   |    |          |                   |   |    |          |                                      |  |      |             |     |     |          |                               |   |    |
| 0H7553D0  | XECC PLUS WASHING SYSTEM PLAT           | 1   | PZ         |  |   |      |             |     |     |          |                           |   |    |          |                                    |   |    |          |                                |   |    |          |                          |   |    |          |                    |    |    |          |                 |   |    |          |                                   |   |    |          |                              |       |   |          |                                |   |    |          |                |   |    |          |                                 |   |    |          |                                   |   |    |          |   |   |    |          |                       |   |    |          |                   |   |    |          |                                      |  |      |             |     |     |          |                               |   |    |

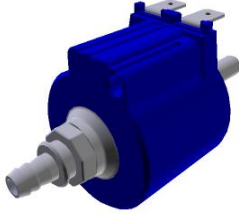
| COMPONENT |   |   | SPARE PART |                                      |  |      |             |     |     |          |   |   |    |          |                                   |   |    |          |                                   |   |    |          |   |   |    |          |                          |   |    |          |                    |    |    |          |                 |   |    |          |   |   |    |          |                              |       |   |          |                                |   |    |          |                |   |    |          |                                   |   |    |          |                                    |   |    |          |                               |   |    |          |   |   |    |          |                       |   |    |          |                   |   |    |
|-----------|---|---|------------|--------------------------------------|--|------|-------------|-----|-----|----------|---|---|----|----------|-----------------------------------|---|----|----------|-----------------------------------|---|----|----------|---|---|----|----------|--------------------------|---|----|----------|--------------------|----|----|----------|-----------------|---|----|----------|---|---|----|----------|------------------------------|-------|---|----------|--------------------------------|---|----|----------|----------------|---|----|----------|-----------------------------------|---|----|----------|------------------------------------|---|----|----------|-------------------------------|---|----|----------|---|---|----|----------|-----------------------|---|----|----------|-------------------|---|----|
| Code      | Description                             | Image   | Code       | Description                          | Components list  |      |             |     |     |          |   |   |    |          |                                   |   |    |          |                                   |   |    |          |   |   |    |          |                          |   |    |          |                    |    |    |          |                 |   |    |          |   |   |    |          |                              |       |   |          |                                |   |    |          |                |   |    |          |                                   |   |    |          |                                    |   |    |          |                               |   |    |          |   |   |    |          |                       |   |    |          |                   |   |    |
| VL1019A   | VIBRATION PUMP                          |  | KVL1120A   | USA COMPACT PLUS CLEANING SYSTEM KIT | <table border="1"> <thead> <tr> <th>Code</th> <th>Description</th> <th>Qty</th> <th>UOM</th> </tr> </thead> <tbody> <tr> <td>EL1422A1</td> <td>1 WAY SOLENOID VALVE + D8-D10 REDUCTION</td> <td>1</td> <td>PZ</td> </tr> <tr> <td>EL1426A0</td> <td>H2O UL SOLENOID JG D8-PIPE HOLDER</td> <td>1</td> <td>PZ</td> </tr> <tr> <td>EL1437A0</td> <td>H2O SOLENOID JG D6 UL CHECK VALVE</td> <td>1</td> <td>PZ</td> </tr> <tr> <td>GN1312A0</td> <td>RUBBER CABLE-PASSI NG DE=26 DI=15 SP=10</td> <td>1</td> <td>PZ</td> </tr> <tr> <td>GN1526A0</td> <td>INT. D.=6.9 TH=1.8 O-RIN</td> <td>1</td> <td>PZ</td> </tr> <tr> <td>RC1019A0</td> <td>D=10 ELASTIC CLAMP</td> <td>10</td> <td>PZ</td> </tr> <tr> <td>RC1242A0</td> <td>D=10 CLOSED CAP</td> <td>2</td> <td>PZ</td> </tr> <tr> <td>RC1356A0</td> <td>STRAIGHT THREADED FEMALE END 8X1/4" BSP</td> <td>1</td> <td>PZ</td> </tr> <tr> <td>TB2820A0</td> <td>PIPE EPDM FOR WASHING SYSTEM</td> <td>1.200</td> <td>M</td> </tr> <tr> <td>VI1220A1</td> <td>4,2X12 TCB SELF-TAPPIN G SCREW</td> <td>9</td> <td>PZ</td> </tr> <tr> <td>VL1019A0</td> <td>VIBRATION PUMP</td> <td>1</td> <td>PZ</td> </tr> <tr> <td>VL1054B0</td> <td>ONE WASHING SYS INLET DISTRIBUTOR</td> <td>1</td> <td>PZ</td> </tr> <tr> <td>VL1064A0</td> <td>WASHING SYSTEM OUTLETS DISTRIBUTOR</td> <td>1</td> <td>PZ</td> </tr> <tr> <td>VL1065A1</td> <td>1/4 MALE N.O. PRESSURE SWITCH</td> <td>1</td> <td>PZ</td> </tr> <tr> <td>VL1102A1</td> <td>DETERGENT LINE FILTER + BARBED VNR 6 MM</td> <td>1</td> <td>PZ</td> </tr> <tr> <td>VL1128A0</td> <td>BARBED CHECK VALVE D6</td> <td>1</td> <td>PZ</td> </tr> <tr> <td>VM2172A0</td> <td>PUMP LOCKING CLIP</td> <td>1</td> <td>PZ</td> </tr> </tbody> </table> | Code | Description | Qty | UOM | EL1422A1 | 1 WAY SOLENOID VALVE + D8-D10 REDUCTION | 1 | PZ | EL1426A0 | H2O UL SOLENOID JG D8-PIPE HOLDER | 1 | PZ | EL1437A0 | H2O SOLENOID JG D6 UL CHECK VALVE | 1 | PZ | GN1312A0 | RUBBER CABLE-PASSI NG DE=26 DI=15 SP=10 | 1 | PZ | GN1526A0 | INT. D.=6.9 TH=1.8 O-RIN | 1 | PZ | RC1019A0 | D=10 ELASTIC CLAMP | 10 | PZ | RC1242A0 | D=10 CLOSED CAP | 2 | PZ | RC1356A0 | STRAIGHT THREADED FEMALE END 8X1/4" BSP | 1 | PZ | TB2820A0 | PIPE EPDM FOR WASHING SYSTEM | 1.200 | M | VI1220A1 | 4,2X12 TCB SELF-TAPPIN G SCREW | 9 | PZ | VL1019A0 | VIBRATION PUMP | 1 | PZ | VL1054B0 | ONE WASHING SYS INLET DISTRIBUTOR | 1 | PZ | VL1064A0 | WASHING SYSTEM OUTLETS DISTRIBUTOR | 1 | PZ | VL1065A1 | 1/4 MALE N.O. PRESSURE SWITCH | 1 | PZ | VL1102A1 | DETERGENT LINE FILTER + BARBED VNR 6 MM | 1 | PZ | VL1128A0 | BARBED CHECK VALVE D6 | 1 | PZ | VM2172A0 | PUMP LOCKING CLIP | 1 | PZ |
| Code      | Description                             | Qty   | UOM        |                                      |  |      |             |     |     |          |   |   |    |          |                                   |   |    |          |                                   |   |    |          |   |   |    |          |                          |   |    |          |                    |    |    |          |                 |   |    |          |   |   |    |          |                              |       |   |          |                                |   |    |          |                |   |    |          |                                   |   |    |          |                                    |   |    |          |                               |   |    |          |   |   |    |          |                       |   |    |          |                   |   |    |
| EL1422A1  | 1 WAY SOLENOID VALVE + D8-D10 REDUCTION | 1   | PZ         |                                      |  |      |             |     |     |          |   |   |    |          |                                   |   |    |          |                                   |   |    |          |   |   |    |          |                          |   |    |          |                    |    |    |          |                 |   |    |          |   |   |    |          |                              |       |   |          |                                |   |    |          |                |   |    |          |                                   |   |    |          |                                    |   |    |          |                               |   |    |          |   |   |    |          |                       |   |    |          |                   |   |    |
| EL1426A0  | H2O UL SOLENOID JG D8-PIPE HOLDER       | 1   | PZ         |                                      |  |      |             |     |     |          |   |   |    |          |                                   |   |    |          |                                   |   |    |          |   |   |    |          |                          |   |    |          |                    |    |    |          |                 |   |    |          |   |   |    |          |                              |       |   |          |                                |   |    |          |                |   |    |          |                                   |   |    |          |                                    |   |    |          |                               |   |    |          |   |   |    |          |                       |   |    |          |                   |   |    |
| EL1437A0  | H2O SOLENOID JG D6 UL CHECK VALVE       | 1   | PZ         |                                      |  |      |             |     |     |          |   |   |    |          |                                   |   |    |          |                                   |   |    |          |   |   |    |          |                          |   |    |          |                    |    |    |          |                 |   |    |          |   |   |    |          |                              |       |   |          |                                |   |    |          |                |   |    |          |                                   |   |    |          |                                    |   |    |          |                               |   |    |          |   |   |    |          |                       |   |    |          |                   |   |    |
| GN1312A0  | RUBBER CABLE-PASSI NG DE=26 DI=15 SP=10 | 1   | PZ         |                                      |  |      |             |     |     |          |   |   |    |          |                                   |   |    |          |                                   |   |    |          |   |   |    |          |                          |   |    |          |                    |    |    |          |                 |   |    |          |   |   |    |          |                              |       |   |          |                                |   |    |          |                |   |    |          |                                   |   |    |          |                                    |   |    |          |                               |   |    |          |   |   |    |          |                       |   |    |          |                   |   |    |
| GN1526A0  | INT. D.=6.9 TH=1.8 O-RIN                | 1   | PZ         |                                      |  |      |             |     |     |          |   |   |    |          |                                   |   |    |          |                                   |   |    |          |   |   |    |          |                          |   |    |          |                    |    |    |          |                 |   |    |          |   |   |    |          |                              |       |   |          |                                |   |    |          |                |   |    |          |                                   |   |    |          |                                    |   |    |          |                               |   |    |          |   |   |    |          |                       |   |    |          |                   |   |    |
| RC1019A0  | D=10 ELASTIC CLAMP                      | 10  | PZ         |                                      |  |      |             |     |     |          |   |   |    |          |                                   |   |    |          |                                   |   |    |          |   |   |    |          |                          |   |    |          |                    |    |    |          |                 |   |    |          |   |   |    |          |                              |       |   |          |                                |   |    |          |                |   |    |          |                                   |   |    |          |                                    |   |    |          |                               |   |    |          |   |   |    |          |                       |   |    |          |                   |   |    |
| RC1242A0  | D=10 CLOSED CAP                         | 2   | PZ         |                                      |  |      |             |     |     |          |   |   |    |          |                                   |   |    |          |                                   |   |    |          |   |   |    |          |                          |   |    |          |                    |    |    |          |                 |   |    |          |   |   |    |          |                              |       |   |          |                                |   |    |          |                |   |    |          |                                   |   |    |          |                                    |   |    |          |                               |   |    |          |   |   |    |          |                       |   |    |          |                   |   |    |
| RC1356A0  | STRAIGHT THREADED FEMALE END 8X1/4" BSP | 1   | PZ         |                                      |  |      |             |     |     |          |   |   |    |          |                                   |   |    |          |                                   |   |    |          |   |   |    |          |                          |   |    |          |                    |    |    |          |                 |   |    |          |   |   |    |          |                              |       |   |          |                                |   |    |          |                |   |    |          |                                   |   |    |          |                                    |   |    |          |                               |   |    |          |   |   |    |          |                       |   |    |          |                   |   |    |
| TB2820A0  | PIPE EPDM FOR WASHING SYSTEM            | 1.200   | M          |                                      |  |      |             |     |     |          |   |   |    |          |                                   |   |    |          |                                   |   |    |          |   |   |    |          |                          |   |    |          |                    |    |    |          |                 |   |    |          |   |   |    |          |                              |       |   |          |                                |   |    |          |                |   |    |          |                                   |   |    |          |                                    |   |    |          |                               |   |    |          |   |   |    |          |                       |   |    |          |                   |   |    |
| VI1220A1  | 4,2X12 TCB SELF-TAPPIN G SCREW          | 9   | PZ         |                                      |  |      |             |     |     |          |   |   |    |          |                                   |   |    |          |                                   |   |    |          |   |   |    |          |                          |   |    |          |                    |    |    |          |                 |   |    |          |   |   |    |          |                              |       |   |          |                                |   |    |          |                |   |    |          |                                   |   |    |          |                                    |   |    |          |                               |   |    |          |   |   |    |          |                       |   |    |          |                   |   |    |
| VL1019A0  | VIBRATION PUMP                          | 1   | PZ         |                                      |  |      |             |     |     |          |   |   |    |          |                                   |   |    |          |                                   |   |    |          |   |   |    |          |                          |   |    |          |                    |    |    |          |                 |   |    |          |   |   |    |          |                              |       |   |          |                                |   |    |          |                |   |    |          |                                   |   |    |          |                                    |   |    |          |                               |   |    |          |   |   |    |          |                       |   |    |          |                   |   |    |
| VL1054B0  | ONE WASHING SYS INLET DISTRIBUTOR       | 1   | PZ         |                                      |  |      |             |     |     |          |   |   |    |          |                                   |   |    |          |                                   |   |    |          |   |   |    |          |                          |   |    |          |                    |    |    |          |                 |   |    |          |   |   |    |          |                              |       |   |          |                                |   |    |          |                |   |    |          |                                   |   |    |          |                                    |   |    |          |                               |   |    |          |   |   |    |          |                       |   |    |          |                   |   |    |
| VL1064A0  | WASHING SYSTEM OUTLETS DISTRIBUTOR      | 1   | PZ         |                                      |  |      |             |     |     |          |   |   |    |          |                                   |   |    |          |                                   |   |    |          |   |   |    |          |                          |   |    |          |                    |    |    |          |                 |   |    |          |   |   |    |          |                              |       |   |          |                                |   |    |          |                |   |    |          |                                   |   |    |          |                                    |   |    |          |                               |   |    |          |   |   |    |          |                       |   |    |          |                   |   |    |
| VL1065A1  | 1/4 MALE N.O. PRESSURE SWITCH           | 1   | PZ         |                                      |  |      |             |     |     |          |   |   |    |          |                                   |   |    |          |                                   |   |    |          |   |   |    |          |                          |   |    |          |                    |    |    |          |                 |   |    |          |   |   |    |          |                              |       |   |          |                                |   |    |          |                |   |    |          |                                   |   |    |          |                                    |   |    |          |                               |   |    |          |   |   |    |          |                       |   |    |          |                   |   |    |
| VL1102A1  | DETERGENT LINE FILTER + BARBED VNR 6 MM | 1   | PZ         |                                      |  |      |             |     |     |          |   |   |    |          |                                   |   |    |          |                                   |   |    |          |   |   |    |          |                          |   |    |          |                    |    |    |          |                 |   |    |          |   |   |    |          |                              |       |   |          |                                |   |    |          |                |   |    |          |                                   |   |    |          |                                    |   |    |          |                               |   |    |          |   |   |    |          |                       |   |    |          |                   |   |    |
| VL1128A0  | BARBED CHECK VALVE D6                   | 1   | PZ         |                                      |  |      |             |     |     |          |   |   |    |          |                                   |   |    |          |                                   |   |    |          |   |   |    |          |                          |   |    |          |                    |    |    |          |                 |   |    |          |   |   |    |          |                              |       |   |          |                                |   |    |          |                |   |    |          |                                   |   |    |          |                                    |   |    |          |                               |   |    |          |   |   |    |          |                       |   |    |          |                   |   |    |
| VM2172A0  | PUMP LOCKING CLIP                       | 1   | PZ         |                                      |  |      |             |     |     |          |   |   |    |          |                                   |   |    |          |                                   |   |    |          |   |   |    |          |                          |   |    |          |                    |    |    |          |                 |   |    |          |   |   |    |          |                              |       |   |          |                                |   |    |          |                |   |    |          |                                   |   |    |          |                                    |   |    |          |                               |   |    |          |   |   |    |          |                       |   |    |          |                   |   |    |

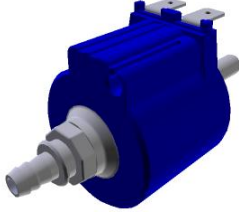
| COMPONENT |   |   | SPARE PART |                                      |  |      |             |     |     |          |                               |   |    |          |                                     |   |    |          |                                    |   |    |          |                                |   |    |          |   |   |    |          |                          |   |    |          |                    |    |    |          |                 |   |    |          |   |   |    |          |                              |       |   |          |                                |    |    |          |                |   |    |          |                                   |   |    |          |                                    |   |    |          |                               |   |    |          |   |   |    |          |                       |   |    |          |                   |   |    |
|-----------|---|---|------------|--------------------------------------|--|------|-------------|-----|-----|----------|-------------------------------|---|----|----------|-------------------------------------|---|----|----------|------------------------------------|---|----|----------|--------------------------------|---|----|----------|---|---|----|----------|--------------------------|---|----|----------|--------------------|----|----|----------|-----------------|---|----|----------|---|---|----|----------|------------------------------|-------|---|----------|--------------------------------|----|----|----------|----------------|---|----|----------|-----------------------------------|---|----|----------|------------------------------------|---|----|----------|-------------------------------|---|----|----------|---|---|----|----------|-----------------------|---|----|----------|-------------------|---|----|
| Code      | Description                             | Image   | Code       | Description                          | Components list  |      |             |     |     |          |                               |   |    |          |                                     |   |    |          |                                    |   |    |          |                                |   |    |          |   |   |    |          |                          |   |    |          |                    |    |    |          |                 |   |    |          |   |   |    |          |                              |       |   |          |                                |    |    |          |                |   |    |          |                                   |   |    |          |                                    |   |    |          |                               |   |    |          |   |   |    |          |                       |   |    |          |                   |   |    |
| VL1019A   | VIBRATION PUMP                          |  | KVL1119A   | EUR COMPACT PLUS CLEANING SYSTEM KIT | <table border="1"> <thead> <tr> <th>Code</th> <th>Description</th> <th>Qty</th> <th>UOM</th> </tr> </thead> <tbody> <tr> <td>0H7553D0</td> <td>XECC PLUS WASHING SYSTEM PLAT</td> <td>1</td> <td>PZ</td> </tr> <tr> <td>EL1252A1</td> <td>1 WAY WATER VALVE + J.G. CONNECTION</td> <td>1</td> <td>PZ</td> </tr> <tr> <td>EL1424A0</td> <td>D8 CONNECTION WATER SOLENOID VALVE</td> <td>1</td> <td>PZ</td> </tr> <tr> <td>EL1436A0</td> <td>H2O SOLENOID JG D8 CHECK VALVE</td> <td>1</td> <td>PZ</td> </tr> <tr> <td>GN1312A0</td> <td>RUBBER CABLE-PASSI NG DE=26 DI=15 SP=10</td> <td>1</td> <td>PZ</td> </tr> <tr> <td>GN1526A0</td> <td>INT. D.=6.9 TH=1.8 O-RIN</td> <td>1</td> <td>PZ</td> </tr> <tr> <td>RC1019A0</td> <td>D=10 ELASTIC CLAMP</td> <td>11</td> <td>PZ</td> </tr> <tr> <td>RC1242A0</td> <td>D=10 CLOSED CAP</td> <td>2</td> <td>PZ</td> </tr> <tr> <td>RC1356A0</td> <td>STRAIGHT THREADED FEMALE END 8X1/4" BSP</td> <td>1</td> <td>PZ</td> </tr> <tr> <td>TB2820A0</td> <td>PIPE EPDM FOR WASHING SYSTEM</td> <td>1.200</td> <td>M</td> </tr> <tr> <td>VI1220A1</td> <td>4,2X12 TCB SELF-TAPPIN G SCREW</td> <td>16</td> <td>PZ</td> </tr> <tr> <td>VL1019A0</td> <td>VIBRATION PUMP</td> <td>1</td> <td>PZ</td> </tr> <tr> <td>VL1054B0</td> <td>ONE WASHING SYS INLET DISTRIBUTOR</td> <td>1</td> <td>PZ</td> </tr> <tr> <td>VL1064A0</td> <td>WASHING SYSTEM OUTLETS DISTRIBUTOR</td> <td>1</td> <td>PZ</td> </tr> <tr> <td>VL1065A1</td> <td>1/4 MALE N.O. PRESSURE SWITCH</td> <td>1</td> <td>PZ</td> </tr> <tr> <td>VL1102A1</td> <td>DETERGENT LINE FILTER + BARBED VNR 6 MM</td> <td>1</td> <td>PZ</td> </tr> <tr> <td>VL1128A0</td> <td>BARBED CHECK VALVE D6</td> <td>1</td> <td>PZ</td> </tr> <tr> <td>VM2172A0</td> <td>PUMP LOCKING CLIP</td> <td>1</td> <td>PZ</td> </tr> </tbody> </table> | Code | Description | Qty | UOM | 0H7553D0 | XECC PLUS WASHING SYSTEM PLAT | 1 | PZ | EL1252A1 | 1 WAY WATER VALVE + J.G. CONNECTION | 1 | PZ | EL1424A0 | D8 CONNECTION WATER SOLENOID VALVE | 1 | PZ | EL1436A0 | H2O SOLENOID JG D8 CHECK VALVE | 1 | PZ | GN1312A0 | RUBBER CABLE-PASSI NG DE=26 DI=15 SP=10 | 1 | PZ | GN1526A0 | INT. D.=6.9 TH=1.8 O-RIN | 1 | PZ | RC1019A0 | D=10 ELASTIC CLAMP | 11 | PZ | RC1242A0 | D=10 CLOSED CAP | 2 | PZ | RC1356A0 | STRAIGHT THREADED FEMALE END 8X1/4" BSP | 1 | PZ | TB2820A0 | PIPE EPDM FOR WASHING SYSTEM | 1.200 | M | VI1220A1 | 4,2X12 TCB SELF-TAPPIN G SCREW | 16 | PZ | VL1019A0 | VIBRATION PUMP | 1 | PZ | VL1054B0 | ONE WASHING SYS INLET DISTRIBUTOR | 1 | PZ | VL1064A0 | WASHING SYSTEM OUTLETS DISTRIBUTOR | 1 | PZ | VL1065A1 | 1/4 MALE N.O. PRESSURE SWITCH | 1 | PZ | VL1102A1 | DETERGENT LINE FILTER + BARBED VNR 6 MM | 1 | PZ | VL1128A0 | BARBED CHECK VALVE D6 | 1 | PZ | VM2172A0 | PUMP LOCKING CLIP | 1 | PZ |
| Code      | Description                             | Qty   | UOM        |                                      |  |      |             |     |     |          |                               |   |    |          |                                     |   |    |          |                                    |   |    |          |                                |   |    |          |   |   |    |          |                          |   |    |          |                    |    |    |          |                 |   |    |          |   |   |    |          |                              |       |   |          |                                |    |    |          |                |   |    |          |                                   |   |    |          |                                    |   |    |          |                               |   |    |          |   |   |    |          |                       |   |    |          |                   |   |    |
| 0H7553D0  | XECC PLUS WASHING SYSTEM PLAT           | 1   | PZ         |                                      |  |      |             |     |     |          |                               |   |    |          |                                     |   |    |          |                                    |   |    |          |                                |   |    |          |   |   |    |          |                          |   |    |          |                    |    |    |          |                 |   |    |          |   |   |    |          |                              |       |   |          |                                |    |    |          |                |   |    |          |                                   |   |    |          |                                    |   |    |          |                               |   |    |          |   |   |    |          |                       |   |    |          |                   |   |    |
| EL1252A1  | 1 WAY WATER VALVE + J.G. CONNECTION     | 1   | PZ         |                                      |  |      |             |     |     |          |                               |   |    |          |                                     |   |    |          |                                    |   |    |          |                                |   |    |          |   |   |    |          |                          |   |    |          |                    |    |    |          |                 |   |    |          |   |   |    |          |                              |       |   |          |                                |    |    |          |                |   |    |          |                                   |   |    |          |                                    |   |    |          |                               |   |    |          |   |   |    |          |                       |   |    |          |                   |   |    |
| EL1424A0  | D8 CONNECTION WATER SOLENOID VALVE      | 1   | PZ         |                                      |  |      |             |     |     |          |                               |   |    |          |                                     |   |    |          |                                    |   |    |          |                                |   |    |          |   |   |    |          |                          |   |    |          |                    |    |    |          |                 |   |    |          |   |   |    |          |                              |       |   |          |                                |    |    |          |                |   |    |          |                                   |   |    |          |                                    |   |    |          |                               |   |    |          |   |   |    |          |                       |   |    |          |                   |   |    |
| EL1436A0  | H2O SOLENOID JG D8 CHECK VALVE          | 1   | PZ         |                                      |  |      |             |     |     |          |                               |   |    |          |                                     |   |    |          |                                    |   |    |          |                                |   |    |          |   |   |    |          |                          |   |    |          |                    |    |    |          |                 |   |    |          |   |   |    |          |                              |       |   |          |                                |    |    |          |                |   |    |          |                                   |   |    |          |                                    |   |    |          |                               |   |    |          |   |   |    |          |                       |   |    |          |                   |   |    |
| GN1312A0  | RUBBER CABLE-PASSI NG DE=26 DI=15 SP=10 | 1   | PZ         |                                      |  |      |             |     |     |          |                               |   |    |          |                                     |   |    |          |                                    |   |    |          |                                |   |    |          |   |   |    |          |                          |   |    |          |                    |    |    |          |                 |   |    |          |   |   |    |          |                              |       |   |          |                                |    |    |          |                |   |    |          |                                   |   |    |          |                                    |   |    |          |                               |   |    |          |   |   |    |          |                       |   |    |          |                   |   |    |
| GN1526A0  | INT. D.=6.9 TH=1.8 O-RIN                | 1   | PZ         |                                      |  |      |             |     |     |          |                               |   |    |          |                                     |   |    |          |                                    |   |    |          |                                |   |    |          |   |   |    |          |                          |   |    |          |                    |    |    |          |                 |   |    |          |   |   |    |          |                              |       |   |          |                                |    |    |          |                |   |    |          |                                   |   |    |          |                                    |   |    |          |                               |   |    |          |   |   |    |          |                       |   |    |          |                   |   |    |
| RC1019A0  | D=10 ELASTIC CLAMP                      | 11  | PZ         |                                      |  |      |             |     |     |          |                               |   |    |          |                                     |   |    |          |                                    |   |    |          |                                |   |    |          |   |   |    |          |                          |   |    |          |                    |    |    |          |                 |   |    |          |   |   |    |          |                              |       |   |          |                                |    |    |          |                |   |    |          |                                   |   |    |          |                                    |   |    |          |                               |   |    |          |   |   |    |          |                       |   |    |          |                   |   |    |
| RC1242A0  | D=10 CLOSED CAP                         | 2   | PZ         |                                      |  |      |             |     |     |          |                               |   |    |          |                                     |   |    |          |                                    |   |    |          |                                |   |    |          |   |   |    |          |                          |   |    |          |                    |    |    |          |                 |   |    |          |   |   |    |          |                              |       |   |          |                                |    |    |          |                |   |    |          |                                   |   |    |          |                                    |   |    |          |                               |   |    |          |   |   |    |          |                       |   |    |          |                   |   |    |
| RC1356A0  | STRAIGHT THREADED FEMALE END 8X1/4" BSP | 1   | PZ         |                                      |  |      |             |     |     |          |                               |   |    |          |                                     |   |    |          |                                    |   |    |          |                                |   |    |          |   |   |    |          |                          |   |    |          |                    |    |    |          |                 |   |    |          |   |   |    |          |                              |       |   |          |                                |    |    |          |                |   |    |          |                                   |   |    |          |                                    |   |    |          |                               |   |    |          |   |   |    |          |                       |   |    |          |                   |   |    |
| TB2820A0  | PIPE EPDM FOR WASHING SYSTEM            | 1.200   | M          |                                      |  |      |             |     |     |          |                               |   |    |          |                                     |   |    |          |                                    |   |    |          |                                |   |    |          |   |   |    |          |                          |   |    |          |                    |    |    |          |                 |   |    |          |   |   |    |          |                              |       |   |          |                                |    |    |          |                |   |    |          |                                   |   |    |          |                                    |   |    |          |                               |   |    |          |   |   |    |          |                       |   |    |          |                   |   |    |
| VI1220A1  | 4,2X12 TCB SELF-TAPPIN G SCREW          | 16  | PZ         |                                      |  |      |             |     |     |          |                               |   |    |          |                                     |   |    |          |                                    |   |    |          |                                |   |    |          |   |   |    |          |                          |   |    |          |                    |    |    |          |                 |   |    |          |   |   |    |          |                              |       |   |          |                                |    |    |          |                |   |    |          |                                   |   |    |          |                                    |   |    |          |                               |   |    |          |   |   |    |          |                       |   |    |          |                   |   |    |
| VL1019A0  | VIBRATION PUMP                          | 1   | PZ         |                                      |  |      |             |     |     |          |                               |   |    |          |                                     |   |    |          |                                    |   |    |          |                                |   |    |          |   |   |    |          |                          |   |    |          |                    |    |    |          |                 |   |    |          |   |   |    |          |                              |       |   |          |                                |    |    |          |                |   |    |          |                                   |   |    |          |                                    |   |    |          |                               |   |    |          |   |   |    |          |                       |   |    |          |                   |   |    |
| VL1054B0  | ONE WASHING SYS INLET DISTRIBUTOR       | 1   | PZ         |                                      |  |      |             |     |     |          |                               |   |    |          |                                     |   |    |          |                                    |   |    |          |                                |   |    |          |   |   |    |          |                          |   |    |          |                    |    |    |          |                 |   |    |          |   |   |    |          |                              |       |   |          |                                |    |    |          |                |   |    |          |                                   |   |    |          |                                    |   |    |          |                               |   |    |          |   |   |    |          |                       |   |    |          |                   |   |    |
| VL1064A0  | WASHING SYSTEM OUTLETS DISTRIBUTOR      | 1   | PZ         |                                      |  |      |             |     |     |          |                               |   |    |          |                                     |   |    |          |                                    |   |    |          |                                |   |    |          |   |   |    |          |                          |   |    |          |                    |    |    |          |                 |   |    |          |   |   |    |          |                              |       |   |          |                                |    |    |          |                |   |    |          |                                   |   |    |          |                                    |   |    |          |                               |   |    |          |   |   |    |          |                       |   |    |          |                   |   |    |
| VL1065A1  | 1/4 MALE N.O. PRESSURE SWITCH           | 1   | PZ         |                                      |  |      |             |     |     |          |                               |   |    |          |                                     |   |    |          |                                    |   |    |          |                                |   |    |          |   |   |    |          |                          |   |    |          |                    |    |    |          |                 |   |    |          |   |   |    |          |                              |       |   |          |                                |    |    |          |                |   |    |          |                                   |   |    |          |                                    |   |    |          |                               |   |    |          |   |   |    |          |                       |   |    |          |                   |   |    |
| VL1102A1  | DETERGENT LINE FILTER + BARBED VNR 6 MM | 1   | PZ         |                                      |  |      |             |     |     |          |                               |   |    |          |                                     |   |    |          |                                    |   |    |          |                                |   |    |          |   |   |    |          |                          |   |    |          |                    |    |    |          |                 |   |    |          |   |   |    |          |                              |       |   |          |                                |    |    |          |                |   |    |          |                                   |   |    |          |                                    |   |    |          |                               |   |    |          |   |   |    |          |                       |   |    |          |                   |   |    |
| VL1128A0  | BARBED CHECK VALVE D6                   | 1   | PZ         |                                      |  |      |             |     |     |          |                               |   |    |          |                                     |   |    |          |                                    |   |    |          |                                |   |    |          |   |   |    |          |                          |   |    |          |                    |    |    |          |                 |   |    |          |   |   |    |          |                              |       |   |          |                                |    |    |          |                |   |    |          |                                   |   |    |          |                                    |   |    |          |                               |   |    |          |   |   |    |          |                       |   |    |          |                   |   |    |
| VM2172A0  | PUMP LOCKING CLIP                       | 1   | PZ         |                                      |  |      |             |     |     |          |                               |   |    |          |                                     |   |    |          |                                    |   |    |          |                                |   |    |          |   |   |    |          |                          |   |    |          |                    |    |    |          |                 |   |    |          |   |   |    |          |                              |       |   |          |                                |    |    |          |                |   |    |          |                                   |   |    |          |                                    |   |    |          |                               |   |    |          |   |   |    |          |                       |   |    |          |                   |   |    |

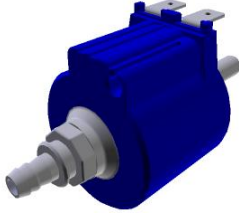
| COMPONENT |   |   | SPARE PART |                                     |   |      |             |     |     |          |                              |   |    |          |                                |   |    |          |                          |   |    |          |                    |    |    |          |                 |   |    |          |                              |       |   |          |                                |   |    |          |                |   |    |          |                                 |   |    |          |                                   |   |    |          |   |   |    |          |                       |   |    |          |                   |   |    |          |  |   |      |             |     |     |          |                                      |   |    |          |   |   |    |          |                  |   |    |          |                 |   |    |
|-----------|---|---|------------|-------------------------------------|---|------|-------------|-----|-----|----------|------------------------------|---|----|----------|--------------------------------|---|----|----------|--------------------------|---|----|----------|--------------------|----|----|----------|-----------------|---|----|----------|------------------------------|-------|---|----------|--------------------------------|---|----|----------|----------------|---|----|----------|---------------------------------|---|----|----------|-----------------------------------|---|----|----------|---|---|----|----------|-----------------------|---|----|----------|-------------------|---|----|----------|--|---|------|-------------|-----|-----|----------|--------------------------------------|---|----|----------|---|---|----|----------|------------------|---|----|----------|-----------------|---|----|
| Code      | Description                             | Image   | Code       | Description                         | Components list   |      |             |     |     |          |                              |   |    |          |                                |   |    |          |                          |   |    |          |                    |    |    |          |                 |   |    |          |                              |       |   |          |                                |   |    |          |                |   |    |          |                                 |   |    |          |                                   |   |    |          |   |   |    |          |                       |   |    |          |                   |   |    |          |  |   |      |             |     |     |          |                                      |   |    |          |   |   |    |          |                  |   |    |          |                 |   |    |
| VL1019A   | VIBRATION PUMP                          |  | KVL1118A   | EUR COMPACT ONE CLEANING SYSTEM KIT | <table border="1"> <thead> <tr> <th>Code</th> <th>Description</th> <th>Qty</th> <th>UOM</th> </tr> </thead> <tbody> <tr> <td>0H7173C0</td> <td>XECC ONE WASHING SYSTEM PLAT</td> <td>1</td> <td>PZ</td> </tr> <tr> <td>EL1436A0</td> <td>H2O SOLENOID JG D8 CHECK VALVE</td> <td>1</td> <td>PZ</td> </tr> <tr> <td>GN1526A0</td> <td>INT. D.=6.9 TH=1.8 O-RIN</td> <td>1</td> <td>PZ</td> </tr> <tr> <td>RC1019A0</td> <td>D=10 ELASTIC CLAMP</td> <td>12</td> <td>PZ</td> </tr> <tr> <td>RC1242A0</td> <td>D=10 CLOSED CAP</td> <td>2</td> <td>PZ</td> </tr> <tr> <td>TB2820A0</td> <td>PIPE EPDM FOR WASHING SYSTEM</td> <td>1.200</td> <td>M</td> </tr> <tr> <td>VI1220A1</td> <td>4,2X12 TCB SELF-TAPPIN G SCREW</td> <td>6</td> <td>PZ</td> </tr> <tr> <td>VL1019A0</td> <td>VIBRATION PUMP</td> <td>1</td> <td>PZ</td> </tr> <tr> <td>VL1053B0</td> <td>ONE WASHING SYS EXT DISTRIBUTOR</td> <td>1</td> <td>PZ</td> </tr> <tr> <td>VL1054B0</td> <td>ONE WASHING SYS INLET DISTRIBUTOR</td> <td>1</td> <td>PZ</td> </tr> <tr> <td>VL1102A1</td> <td>DETERGENT LINE FILTER + BARBED VNR 6 MM</td> <td>1</td> <td>PZ</td> </tr> <tr> <td>VL1128A0</td> <td>BARBED CHECK VALVE D6</td> <td>1</td> <td>PZ</td> </tr> <tr> <td>VM2172A0</td> <td>PUMP LOCKING CLIP</td> <td>1</td> <td>PZ</td> </tr> </tbody> </table> | Code | Description | Qty | UOM | 0H7173C0 | XECC ONE WASHING SYSTEM PLAT | 1 | PZ | EL1436A0 | H2O SOLENOID JG D8 CHECK VALVE | 1 | PZ | GN1526A0 | INT. D.=6.9 TH=1.8 O-RIN | 1 | PZ | RC1019A0 | D=10 ELASTIC CLAMP | 12 | PZ | RC1242A0 | D=10 CLOSED CAP | 2 | PZ | TB2820A0 | PIPE EPDM FOR WASHING SYSTEM | 1.200 | M | VI1220A1 | 4,2X12 TCB SELF-TAPPIN G SCREW | 6 | PZ | VL1019A0 | VIBRATION PUMP | 1 | PZ | VL1053B0 | ONE WASHING SYS EXT DISTRIBUTOR | 1 | PZ | VL1054B0 | ONE WASHING SYS INLET DISTRIBUTOR | 1 | PZ | VL1102A1 | DETERGENT LINE FILTER + BARBED VNR 6 MM | 1 | PZ | VL1128A0 | BARBED CHECK VALVE D6 | 1 | PZ | VM2172A0 | PUMP LOCKING CLIP | 1 | PZ | KVL1109A | EUR 2 ROTOR ARMS ONE CLEANING SYSTEM KIT | <table border="1"> <thead> <tr> <th>Code</th> <th>Description</th> <th>Qty</th> <th>UOM</th> </tr> </thead> <tbody> <tr> <td>0H7324A0</td> <td>ONE OVENS WASHING SYST HOLDING PLATE</td> <td>2</td> <td>PZ</td> </tr> <tr> <td>0H7515A0</td> <td>XEVC-2011-E1 R DOUBLE WASHING SYS PLATE</td> <td>1</td> <td>PZ</td> </tr> <tr> <td>CH1000A0</td> <td>SNIP PIPE CUTTER</td> <td>1</td> <td>PZ</td> </tr> <tr> <td>EL1115A0</td> <td>Ø8 Y CONNECTION</td> <td>1</td> <td>PZ</td> </tr> </tbody> </table> | Code | Description | Qty | UOM | 0H7324A0 | ONE OVENS WASHING SYST HOLDING PLATE | 2 | PZ | 0H7515A0 | XEVC-2011-E1 R DOUBLE WASHING SYS PLATE | 1 | PZ | CH1000A0 | SNIP PIPE CUTTER | 1 | PZ | EL1115A0 | Ø8 Y CONNECTION | 1 | PZ |
|           |   |   | Code       | Description                         | Qty   | UOM  |             |     |     |          |                              |   |    |          |                                |   |    |          |                          |   |    |          |                    |    |    |          |                 |   |    |          |                              |       |   |          |                                |   |    |          |                |   |    |          |                                 |   |    |          |                                   |   |    |          |   |   |    |          |                       |   |    |          |                   |   |    |          |  |   |      |             |     |     |          |                                      |   |    |          |   |   |    |          |                  |   |    |          |                 |   |    |
| 0H7173C0  | XECC ONE WASHING SYSTEM PLAT            | 1   | PZ         |                                     |   |      |             |     |     |          |                              |   |    |          |                                |   |    |          |                          |   |    |          |                    |    |    |          |                 |   |    |          |                              |       |   |          |                                |   |    |          |                |   |    |          |                                 |   |    |          |                                   |   |    |          |   |   |    |          |                       |   |    |          |                   |   |    |          |  |   |      |             |     |     |          |                                      |   |    |          |   |   |    |          |                  |   |    |          |                 |   |    |
| EL1436A0  | H2O SOLENOID JG D8 CHECK VALVE          | 1   | PZ         |                                     |   |      |             |     |     |          |                              |   |    |          |                                |   |    |          |                          |   |    |          |                    |    |    |          |                 |   |    |          |                              |       |   |          |                                |   |    |          |                |   |    |          |                                 |   |    |          |                                   |   |    |          |   |   |    |          |                       |   |    |          |                   |   |    |          |  |   |      |             |     |     |          |                                      |   |    |          |   |   |    |          |                  |   |    |          |                 |   |    |
| GN1526A0  | INT. D.=6.9 TH=1.8 O-RIN                | 1   | PZ         |                                     |   |      |             |     |     |          |                              |   |    |          |                                |   |    |          |                          |   |    |          |                    |    |    |          |                 |   |    |          |                              |       |   |          |                                |   |    |          |                |   |    |          |                                 |   |    |          |                                   |   |    |          |   |   |    |          |                       |   |    |          |                   |   |    |          |  |   |      |             |     |     |          |                                      |   |    |          |   |   |    |          |                  |   |    |          |                 |   |    |
| RC1019A0  | D=10 ELASTIC CLAMP                      | 12  | PZ         |                                     |   |      |             |     |     |          |                              |   |    |          |                                |   |    |          |                          |   |    |          |                    |    |    |          |                 |   |    |          |                              |       |   |          |                                |   |    |          |                |   |    |          |                                 |   |    |          |                                   |   |    |          |   |   |    |          |                       |   |    |          |                   |   |    |          |  |   |      |             |     |     |          |                                      |   |    |          |   |   |    |          |                  |   |    |          |                 |   |    |
| RC1242A0  | D=10 CLOSED CAP                         | 2   | PZ         |                                     |   |      |             |     |     |          |                              |   |    |          |                                |   |    |          |                          |   |    |          |                    |    |    |          |                 |   |    |          |                              |       |   |          |                                |   |    |          |                |   |    |          |                                 |   |    |          |                                   |   |    |          |   |   |    |          |                       |   |    |          |                   |   |    |          |  |   |      |             |     |     |          |                                      |   |    |          |   |   |    |          |                  |   |    |          |                 |   |    |
| TB2820A0  | PIPE EPDM FOR WASHING SYSTEM            | 1.200   | M          |                                     |   |      |             |     |     |          |                              |   |    |          |                                |   |    |          |                          |   |    |          |                    |    |    |          |                 |   |    |          |                              |       |   |          |                                |   |    |          |                |   |    |          |                                 |   |    |          |                                   |   |    |          |   |   |    |          |                       |   |    |          |                   |   |    |          |  |   |      |             |     |     |          |                                      |   |    |          |   |   |    |          |                  |   |    |          |                 |   |    |
| VI1220A1  | 4,2X12 TCB SELF-TAPPIN G SCREW          | 6   | PZ         |                                     |   |      |             |     |     |          |                              |   |    |          |                                |   |    |          |                          |   |    |          |                    |    |    |          |                 |   |    |          |                              |       |   |          |                                |   |    |          |                |   |    |          |                                 |   |    |          |                                   |   |    |          |   |   |    |          |                       |   |    |          |                   |   |    |          |  |   |      |             |     |     |          |                                      |   |    |          |   |   |    |          |                  |   |    |          |                 |   |    |
| VL1019A0  | VIBRATION PUMP                          | 1   | PZ         |                                     |   |      |             |     |     |          |                              |   |    |          |                                |   |    |          |                          |   |    |          |                    |    |    |          |                 |   |    |          |                              |       |   |          |                                |   |    |          |                |   |    |          |                                 |   |    |          |                                   |   |    |          |   |   |    |          |                       |   |    |          |                   |   |    |          |  |   |      |             |     |     |          |                                      |   |    |          |   |   |    |          |                  |   |    |          |                 |   |    |
| VL1053B0  | ONE WASHING SYS EXT DISTRIBUTOR         | 1   | PZ         |                                     |   |      |             |     |     |          |                              |   |    |          |                                |   |    |          |                          |   |    |          |                    |    |    |          |                 |   |    |          |                              |       |   |          |                                |   |    |          |                |   |    |          |                                 |   |    |          |                                   |   |    |          |   |   |    |          |                       |   |    |          |                   |   |    |          |  |   |      |             |     |     |          |                                      |   |    |          |   |   |    |          |                  |   |    |          |                 |   |    |
| VL1054B0  | ONE WASHING SYS INLET DISTRIBUTOR       | 1   | PZ         |                                     |   |      |             |     |     |          |                              |   |    |          |                                |   |    |          |                          |   |    |          |                    |    |    |          |                 |   |    |          |                              |       |   |          |                                |   |    |          |                |   |    |          |                                 |   |    |          |                                   |   |    |          |   |   |    |          |                       |   |    |          |                   |   |    |          |  |   |      |             |     |     |          |                                      |   |    |          |   |   |    |          |                  |   |    |          |                 |   |    |
| VL1102A1  | DETERGENT LINE FILTER + BARBED VNR 6 MM | 1   | PZ         |                                     |   |      |             |     |     |          |                              |   |    |          |                                |   |    |          |                          |   |    |          |                    |    |    |          |                 |   |    |          |                              |       |   |          |                                |   |    |          |                |   |    |          |                                 |   |    |          |                                   |   |    |          |   |   |    |          |                       |   |    |          |                   |   |    |          |  |   |      |             |     |     |          |                                      |   |    |          |   |   |    |          |                  |   |    |          |                 |   |    |
| VL1128A0  | BARBED CHECK VALVE D6                   | 1   | PZ         |                                     |   |      |             |     |     |          |                              |   |    |          |                                |   |    |          |                          |   |    |          |                    |    |    |          |                 |   |    |          |                              |       |   |          |                                |   |    |          |                |   |    |          |                                 |   |    |          |                                   |   |    |          |   |   |    |          |                       |   |    |          |                   |   |    |          |  |   |      |             |     |     |          |                                      |   |    |          |   |   |    |          |                  |   |    |          |                 |   |    |
| VM2172A0  | PUMP LOCKING CLIP                       | 1   | PZ         |                                     |   |      |             |     |     |          |                              |   |    |          |                                |   |    |          |                          |   |    |          |                    |    |    |          |                 |   |    |          |                              |       |   |          |                                |   |    |          |                |   |    |          |                                 |   |    |          |                                   |   |    |          |   |   |    |          |                       |   |    |          |                   |   |    |          |  |   |      |             |     |     |          |                                      |   |    |          |   |   |    |          |                  |   |    |          |                 |   |    |
| Code      | Description                             | Qty   | UOM        |                                     |   |      |             |     |     |          |                              |   |    |          |                                |   |    |          |                          |   |    |          |                    |    |    |          |                 |   |    |          |                              |       |   |          |                                |   |    |          |                |   |    |          |                                 |   |    |          |                                   |   |    |          |   |   |    |          |                       |   |    |          |                   |   |    |          |  |   |      |             |     |     |          |                                      |   |    |          |   |   |    |          |                  |   |    |          |                 |   |    |
| 0H7324A0  | ONE OVENS WASHING SYST HOLDING PLATE    | 2   | PZ         |                                     |   |      |             |     |     |          |                              |   |    |          |                                |   |    |          |                          |   |    |          |                    |    |    |          |                 |   |    |          |                              |       |   |          |                                |   |    |          |                |   |    |          |                                 |   |    |          |                                   |   |    |          |   |   |    |          |                       |   |    |          |                   |   |    |          |  |   |      |             |     |     |          |                                      |   |    |          |   |   |    |          |                  |   |    |          |                 |   |    |
| 0H7515A0  | XEVC-2011-E1 R DOUBLE WASHING SYS PLATE | 1   | PZ         |                                     |   |      |             |     |     |          |                              |   |    |          |                                |   |    |          |                          |   |    |          |                    |    |    |          |                 |   |    |          |                              |       |   |          |                                |   |    |          |                |   |    |          |                                 |   |    |          |                                   |   |    |          |   |   |    |          |                       |   |    |          |                   |   |    |          |  |   |      |             |     |     |          |                                      |   |    |          |   |   |    |          |                  |   |    |          |                 |   |    |
| CH1000A0  | SNIP PIPE CUTTER                        | 1   | PZ         |                                     |   |      |             |     |     |          |                              |   |    |          |                                |   |    |          |                          |   |    |          |                    |    |    |          |                 |   |    |          |                              |       |   |          |                                |   |    |          |                |   |    |          |                                 |   |    |          |                                   |   |    |          |   |   |    |          |                       |   |    |          |                   |   |    |          |  |   |      |             |     |     |          |                                      |   |    |          |   |   |    |          |                  |   |    |          |                 |   |    |
| EL1115A0  | Ø8 Y CONNECTION                         | 1   | PZ         |                                     |   |      |             |     |     |          |                              |   |    |          |                                |   |    |          |                          |   |    |          |                    |    |    |          |                 |   |    |          |                              |       |   |          |                                |   |    |          |                |   |    |          |                                 |   |    |          |                                   |   |    |          |   |   |    |          |                       |   |    |          |                   |   |    |          |  |   |      |             |     |     |          |                                      |   |    |          |   |   |    |          |                  |   |    |          |                 |   |    |

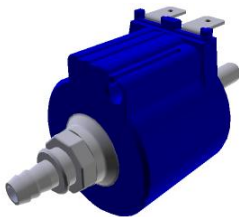
| COMPONENT |  |   | SPARE PART |  |  |      |             |     |     |          |   |   |    |          |                             |   |    |          |                           |   |    |          |                       |    |    |          |                    |   |    |          |                       |       |   |          |                                    |       |   |          |                                      |   |    |          |                   |   |    |          |  |   |    |          |  |   |    |          |  |   |    |          |                             |   |    |          |                      |   |    |          |  |   |      |             |     |     |          |  |   |    |          |   |   |    |          |                             |   |    |          |                           |   |    |
|-----------|--|---|------------|--|--|------|-------------|-----|-----|----------|---|---|----|----------|-----------------------------|---|----|----------|---------------------------|---|----|----------|-----------------------|----|----|----------|--------------------|---|----|----------|-----------------------|-------|---|----------|------------------------------------|-------|---|----------|--------------------------------------|---|----|----------|-------------------|---|----|----------|--|---|----|----------|--|---|----|----------|--|---|----|----------|-----------------------------|---|----|----------|----------------------|---|----|----------|--|---|------|-------------|-----|-----|----------|--|---|----|----------|---|---|----|----------|-----------------------------|---|----|----------|---------------------------|---|----|
| Code      | Description                                      | Image   | Code       | Description                                    | Components list  |      |             |     |     |          |   |   |    |          |                             |   |    |          |                           |   |    |          |                       |    |    |          |                    |   |    |          |                       |       |   |          |                                    |       |   |          |                                      |   |    |          |                   |   |    |          |  |   |    |          |  |   |    |          |  |   |    |          |                             |   |    |          |                      |   |    |          |  |   |      |             |     |     |          |  |   |    |          |   |   |    |          |                             |   |    |          |                           |   |    |
| VL1019A   | VIBRATION PUMP                                   |  | KVL1109A   | EUR 2 ROTOR ARMS<br>ONE CLEANING<br>SYSTEM KIT | <table border="1"> <thead> <tr> <th>Code</th> <th>Description</th> <th>Qty</th> <th>UOM</th> </tr> </thead> <tbody> <tr> <td>EL1436A0</td> <td>H2O<br/>SOLENOID JG<br/>D8 CHECK<br/>VALVE</td> <td>2</td> <td>PZ</td> </tr> <tr> <td>GN1526A0</td> <td>INT. D.=6.9<br/>TH=1.8 O-RIN</td> <td>2</td> <td>PZ</td> </tr> <tr> <td>RC1006A0</td> <td>D8 PET PIPE<br/>GUIDE BEND</td> <td>4</td> <td>PZ</td> </tr> <tr> <td>RC1019A0</td> <td>D=10 ELASTIC<br/>CLAMP</td> <td>26</td> <td>PZ</td> </tr> <tr> <td>RC1242A0</td> <td>D=10 CLOSED<br/>CAP</td> <td>4</td> <td>PZ</td> </tr> <tr> <td>TB1818A0</td> <td>JG Ø8 BLUE<br/>PE PIPE</td> <td>1.640</td> <td>M</td> </tr> <tr> <td>TB2820A0</td> <td>PIPE EPDM<br/>FOR WASHING<br/>SYSTEM</td> <td>3.940</td> <td>M</td> </tr> <tr> <td>VI1220A1</td> <td>4,2X12 TCB<br/>SELF-TAPPIN<br/>G SCREW</td> <td>8</td> <td>PZ</td> </tr> <tr> <td>VL1019A0</td> <td>VIBRATION<br/>PUMP</td> <td>2</td> <td>PZ</td> </tr> <tr> <td>VL1053B0</td> <td>ONE<br/>WASHING SYS<br/>EXT<br/>DISTRIBUTOR</td> <td>2</td> <td>PZ</td> </tr> <tr> <td>VL1054B0</td> <td>ONE<br/>WASHING SYS<br/>INLET<br/>DISTRIBUTOR</td> <td>2</td> <td>PZ</td> </tr> <tr> <td>VL1102A1</td> <td>DETERGENT<br/>LINE FILTER +<br/>BARBED VNR<br/>6 MM</td> <td>2</td> <td>PZ</td> </tr> <tr> <td>VL1128A0</td> <td>BARBED<br/>CHECK VALVE<br/>D6</td> <td>2</td> <td>PZ</td> </tr> <tr> <td>VM2172A0</td> <td>PUMP<br/>LOCKING CLIP</td> <td>2</td> <td>PZ</td> </tr> </tbody> </table> | Code | Description | Qty | UOM | EL1436A0 | H2O<br>SOLENOID JG<br>D8 CHECK<br>VALVE | 2 | PZ | GN1526A0 | INT. D.=6.9<br>TH=1.8 O-RIN | 2 | PZ | RC1006A0 | D8 PET PIPE<br>GUIDE BEND | 4 | PZ | RC1019A0 | D=10 ELASTIC<br>CLAMP | 26 | PZ | RC1242A0 | D=10 CLOSED<br>CAP | 4 | PZ | TB1818A0 | JG Ø8 BLUE<br>PE PIPE | 1.640 | M | TB2820A0 | PIPE EPDM<br>FOR WASHING<br>SYSTEM | 3.940 | M | VI1220A1 | 4,2X12 TCB<br>SELF-TAPPIN<br>G SCREW | 8 | PZ | VL1019A0 | VIBRATION<br>PUMP | 2 | PZ | VL1053B0 | ONE<br>WASHING SYS<br>EXT<br>DISTRIBUTOR | 2 | PZ | VL1054B0 | ONE<br>WASHING SYS<br>INLET<br>DISTRIBUTOR | 2 | PZ | VL1102A1 | DETERGENT<br>LINE FILTER +<br>BARBED VNR<br>6 MM | 2 | PZ | VL1128A0 | BARBED<br>CHECK VALVE<br>D6 | 2 | PZ | VM2172A0 | PUMP<br>LOCKING CLIP | 2 | PZ | KVL1108A | 04EU ONE EUR 1<br>ROTOR CLEANING<br>SYSTEM KIT | <table border="1"> <thead> <tr> <th>Code</th> <th>Description</th> <th>Qty</th> <th>UOM</th> </tr> </thead> <tbody> <tr> <td>0H7511A0</td> <td>ONE OVENS<br/>WASHING<br/>SYST<br/>HOLDING<br/>PLATE</td> <td>1</td> <td>PZ</td> </tr> <tr> <td>EL1436A0</td> <td>H2O<br/>SOLENOID JG<br/>D8 CHECK<br/>VALVE</td> <td>1</td> <td>PZ</td> </tr> <tr> <td>GN1526A0</td> <td>INT. D.=6.9<br/>TH=1.8 O-RIN</td> <td>1</td> <td>PZ</td> </tr> <tr> <td>RC1006A0</td> <td>D8 PET PIPE<br/>GUIDE BEND</td> <td>2</td> <td>PZ</td> </tr> </tbody> </table> | Code | Description | Qty | UOM | 0H7511A0 | ONE OVENS<br>WASHING<br>SYST<br>HOLDING<br>PLATE | 1 | PZ | EL1436A0 | H2O<br>SOLENOID JG<br>D8 CHECK<br>VALVE | 1 | PZ | GN1526A0 | INT. D.=6.9<br>TH=1.8 O-RIN | 1 | PZ | RC1006A0 | D8 PET PIPE<br>GUIDE BEND | 2 | PZ |
|           |  |   | Code       | Description                                    | Qty  | UOM  |             |     |     |          |   |   |    |          |                             |   |    |          |                           |   |    |          |                       |    |    |          |                    |   |    |          |                       |       |   |          |                                    |       |   |          |                                      |   |    |          |                   |   |    |          |  |   |    |          |  |   |    |          |  |   |    |          |                             |   |    |          |                      |   |    |          |  |   |      |             |     |     |          |  |   |    |          |   |   |    |          |                             |   |    |          |                           |   |    |
| EL1436A0  | H2O<br>SOLENOID JG<br>D8 CHECK<br>VALVE          | 2   | PZ         |  |  |      |             |     |     |          |   |   |    |          |                             |   |    |          |                           |   |    |          |                       |    |    |          |                    |   |    |          |                       |       |   |          |                                    |       |   |          |                                      |   |    |          |                   |   |    |          |  |   |    |          |  |   |    |          |  |   |    |          |                             |   |    |          |                      |   |    |          |  |   |      |             |     |     |          |  |   |    |          |   |   |    |          |                             |   |    |          |                           |   |    |
| GN1526A0  | INT. D.=6.9<br>TH=1.8 O-RIN                      | 2   | PZ         |  |  |      |             |     |     |          |   |   |    |          |                             |   |    |          |                           |   |    |          |                       |    |    |          |                    |   |    |          |                       |       |   |          |                                    |       |   |          |                                      |   |    |          |                   |   |    |          |  |   |    |          |  |   |    |          |  |   |    |          |                             |   |    |          |                      |   |    |          |  |   |      |             |     |     |          |  |   |    |          |   |   |    |          |                             |   |    |          |                           |   |    |
| RC1006A0  | D8 PET PIPE<br>GUIDE BEND                        | 4   | PZ         |  |  |      |             |     |     |          |   |   |    |          |                             |   |    |          |                           |   |    |          |                       |    |    |          |                    |   |    |          |                       |       |   |          |                                    |       |   |          |                                      |   |    |          |                   |   |    |          |  |   |    |          |  |   |    |          |  |   |    |          |                             |   |    |          |                      |   |    |          |  |   |      |             |     |     |          |  |   |    |          |   |   |    |          |                             |   |    |          |                           |   |    |
| RC1019A0  | D=10 ELASTIC<br>CLAMP                            | 26  | PZ         |  |  |      |             |     |     |          |   |   |    |          |                             |   |    |          |                           |   |    |          |                       |    |    |          |                    |   |    |          |                       |       |   |          |                                    |       |   |          |                                      |   |    |          |                   |   |    |          |  |   |    |          |  |   |    |          |  |   |    |          |                             |   |    |          |                      |   |    |          |  |   |      |             |     |     |          |  |   |    |          |   |   |    |          |                             |   |    |          |                           |   |    |
| RC1242A0  | D=10 CLOSED<br>CAP                               | 4   | PZ         |  |  |      |             |     |     |          |   |   |    |          |                             |   |    |          |                           |   |    |          |                       |    |    |          |                    |   |    |          |                       |       |   |          |                                    |       |   |          |                                      |   |    |          |                   |   |    |          |  |   |    |          |  |   |    |          |  |   |    |          |                             |   |    |          |                      |   |    |          |  |   |      |             |     |     |          |  |   |    |          |   |   |    |          |                             |   |    |          |                           |   |    |
| TB1818A0  | JG Ø8 BLUE<br>PE PIPE                            | 1.640   | M          |  |  |      |             |     |     |          |   |   |    |          |                             |   |    |          |                           |   |    |          |                       |    |    |          |                    |   |    |          |                       |       |   |          |                                    |       |   |          |                                      |   |    |          |                   |   |    |          |  |   |    |          |  |   |    |          |  |   |    |          |                             |   |    |          |                      |   |    |          |  |   |      |             |     |     |          |  |   |    |          |   |   |    |          |                             |   |    |          |                           |   |    |
| TB2820A0  | PIPE EPDM<br>FOR WASHING<br>SYSTEM               | 3.940   | M          |  |  |      |             |     |     |          |   |   |    |          |                             |   |    |          |                           |   |    |          |                       |    |    |          |                    |   |    |          |                       |       |   |          |                                    |       |   |          |                                      |   |    |          |                   |   |    |          |  |   |    |          |  |   |    |          |  |   |    |          |                             |   |    |          |                      |   |    |          |  |   |      |             |     |     |          |  |   |    |          |   |   |    |          |                             |   |    |          |                           |   |    |
| VI1220A1  | 4,2X12 TCB<br>SELF-TAPPIN<br>G SCREW             | 8   | PZ         |  |  |      |             |     |     |          |   |   |    |          |                             |   |    |          |                           |   |    |          |                       |    |    |          |                    |   |    |          |                       |       |   |          |                                    |       |   |          |                                      |   |    |          |                   |   |    |          |  |   |    |          |  |   |    |          |  |   |    |          |                             |   |    |          |                      |   |    |          |  |   |      |             |     |     |          |  |   |    |          |   |   |    |          |                             |   |    |          |                           |   |    |
| VL1019A0  | VIBRATION<br>PUMP                                | 2   | PZ         |  |  |      |             |     |     |          |   |   |    |          |                             |   |    |          |                           |   |    |          |                       |    |    |          |                    |   |    |          |                       |       |   |          |                                    |       |   |          |                                      |   |    |          |                   |   |    |          |  |   |    |          |  |   |    |          |  |   |    |          |                             |   |    |          |                      |   |    |          |  |   |      |             |     |     |          |  |   |    |          |   |   |    |          |                             |   |    |          |                           |   |    |
| VL1053B0  | ONE<br>WASHING SYS<br>EXT<br>DISTRIBUTOR         | 2   | PZ         |  |  |      |             |     |     |          |   |   |    |          |                             |   |    |          |                           |   |    |          |                       |    |    |          |                    |   |    |          |                       |       |   |          |                                    |       |   |          |                                      |   |    |          |                   |   |    |          |  |   |    |          |  |   |    |          |  |   |    |          |                             |   |    |          |                      |   |    |          |  |   |      |             |     |     |          |  |   |    |          |   |   |    |          |                             |   |    |          |                           |   |    |
| VL1054B0  | ONE<br>WASHING SYS<br>INLET<br>DISTRIBUTOR       | 2   | PZ         |  |  |      |             |     |     |          |   |   |    |          |                             |   |    |          |                           |   |    |          |                       |    |    |          |                    |   |    |          |                       |       |   |          |                                    |       |   |          |                                      |   |    |          |                   |   |    |          |  |   |    |          |  |   |    |          |  |   |    |          |                             |   |    |          |                      |   |    |          |  |   |      |             |     |     |          |  |   |    |          |   |   |    |          |                             |   |    |          |                           |   |    |
| VL1102A1  | DETERGENT<br>LINE FILTER +<br>BARBED VNR<br>6 MM | 2   | PZ         |  |  |      |             |     |     |          |   |   |    |          |                             |   |    |          |                           |   |    |          |                       |    |    |          |                    |   |    |          |                       |       |   |          |                                    |       |   |          |                                      |   |    |          |                   |   |    |          |  |   |    |          |  |   |    |          |  |   |    |          |                             |   |    |          |                      |   |    |          |  |   |      |             |     |     |          |  |   |    |          |   |   |    |          |                             |   |    |          |                           |   |    |
| VL1128A0  | BARBED<br>CHECK VALVE<br>D6                      | 2   | PZ         |  |  |      |             |     |     |          |   |   |    |          |                             |   |    |          |                           |   |    |          |                       |    |    |          |                    |   |    |          |                       |       |   |          |                                    |       |   |          |                                      |   |    |          |                   |   |    |          |  |   |    |          |  |   |    |          |  |   |    |          |                             |   |    |          |                      |   |    |          |  |   |      |             |     |     |          |  |   |    |          |   |   |    |          |                             |   |    |          |                           |   |    |
| VM2172A0  | PUMP<br>LOCKING CLIP                             | 2   | PZ         |  |  |      |             |     |     |          |   |   |    |          |                             |   |    |          |                           |   |    |          |                       |    |    |          |                    |   |    |          |                       |       |   |          |                                    |       |   |          |                                      |   |    |          |                   |   |    |          |  |   |    |          |  |   |    |          |  |   |    |          |                             |   |    |          |                      |   |    |          |  |   |      |             |     |     |          |  |   |    |          |   |   |    |          |                             |   |    |          |                           |   |    |
| Code      | Description                                      | Qty   | UOM        |  |  |      |             |     |     |          |   |   |    |          |                             |   |    |          |                           |   |    |          |                       |    |    |          |                    |   |    |          |                       |       |   |          |                                    |       |   |          |                                      |   |    |          |                   |   |    |          |  |   |    |          |  |   |    |          |  |   |    |          |                             |   |    |          |                      |   |    |          |  |   |      |             |     |     |          |  |   |    |          |   |   |    |          |                             |   |    |          |                           |   |    |
| 0H7511A0  | ONE OVENS<br>WASHING<br>SYST<br>HOLDING<br>PLATE | 1   | PZ         |  |  |      |             |     |     |          |   |   |    |          |                             |   |    |          |                           |   |    |          |                       |    |    |          |                    |   |    |          |                       |       |   |          |                                    |       |   |          |                                      |   |    |          |                   |   |    |          |  |   |    |          |  |   |    |          |  |   |    |          |                             |   |    |          |                      |   |    |          |  |   |      |             |     |     |          |  |   |    |          |   |   |    |          |                             |   |    |          |                           |   |    |
| EL1436A0  | H2O<br>SOLENOID JG<br>D8 CHECK<br>VALVE          | 1   | PZ         |  |  |      |             |     |     |          |   |   |    |          |                             |   |    |          |                           |   |    |          |                       |    |    |          |                    |   |    |          |                       |       |   |          |                                    |       |   |          |                                      |   |    |          |                   |   |    |          |  |   |    |          |  |   |    |          |  |   |    |          |                             |   |    |          |                      |   |    |          |  |   |      |             |     |     |          |  |   |    |          |   |   |    |          |                             |   |    |          |                           |   |    |
| GN1526A0  | INT. D.=6.9<br>TH=1.8 O-RIN                      | 1   | PZ         |  |  |      |             |     |     |          |   |   |    |          |                             |   |    |          |                           |   |    |          |                       |    |    |          |                    |   |    |          |                       |       |   |          |                                    |       |   |          |                                      |   |    |          |                   |   |    |          |  |   |    |          |  |   |    |          |  |   |    |          |                             |   |    |          |                      |   |    |          |  |   |      |             |     |     |          |  |   |    |          |   |   |    |          |                             |   |    |          |                           |   |    |
| RC1006A0  | D8 PET PIPE<br>GUIDE BEND                        | 2   | PZ         |  |  |      |             |     |     |          |   |   |    |          |                             |   |    |          |                           |   |    |          |                       |    |    |          |                    |   |    |          |                       |       |   |          |                                    |       |   |          |                                      |   |    |          |                   |   |    |          |  |   |    |          |  |   |    |          |  |   |    |          |                             |   |    |          |                      |   |    |          |  |   |      |             |     |     |          |  |   |    |          |   |   |    |          |                             |   |    |          |                           |   |    |

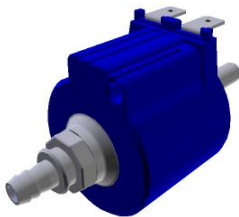
| COMPONENT |   |   | SPARE PART |  |   |      |             |                              |     |          |                    |                                     |    |          |                 |                                    |    |          |                    |                                |   |          |                              |                          |   |          |                                |                    |    |          |                |              |    |          |                                 |                 |    |          |                                   |                       |    |          |                       |   |    |          |                   |   |    |
|-----------|---|---|------------|--|---|------|-------------|------------------------------|-----|----------|--------------------|-------------------------------------|----|----------|-----------------|------------------------------------|----|----------|--------------------|--------------------------------|---|----------|------------------------------|--------------------------|---|----------|--------------------------------|--------------------|----|----------|----------------|--------------|----|----------|---------------------------------|-----------------|----|----------|-----------------------------------|-----------------------|----|----------|-----------------------|---|----|----------|-------------------|---|----|
| Code      | Description                               | Image   | Code       | Description                              | Components list   |      |             |                              |     |          |                    |                                     |    |          |                 |                                    |    |          |                    |                                |   |          |                              |                          |   |          |                                |                    |    |          |                |              |    |          |                                 |                 |    |          |                                   |                       |    |          |                       |   |    |          |                   |   |    |
| VL1019A   | VIBRATION PUMP                            |    | KVL1108A   | 04EU ONE EUR 1 ROTOR CLEANING SYSTEM KIT | <table border="1"> <thead> <tr> <th>Code</th> <th>Description</th> <th>Qty</th> <th>UOM</th> </tr> </thead> <tbody> <tr> <td>RC1019A0</td> <td>D=10 ELASTIC CLAMP</td> <td>17</td> <td>PZ</td> </tr> <tr> <td>RC1242A0</td> <td>D=10 CLOSED CAP</td> <td>2</td> <td>PZ</td> </tr> <tr> <td>TB1818A0</td> <td>JG Ø8 BLUE PE PIPE</td> <td>0.320</td> <td>M</td> </tr> <tr> <td>TB2820A0</td> <td>PIPE EPDM FOR WASHING SYSTEM</td> <td>1.380</td> <td>M</td> </tr> <tr> <td>VI1220A1</td> <td>4,2X12 TCB SELF-TAPPIN G SCREW</td> <td>1</td> <td>PZ</td> </tr> <tr> <td>VL1019A0</td> <td>VIBRATION PUMP</td> <td>2</td> <td>PZ</td> </tr> <tr> <td>VL1053B0</td> <td>ONE WASHING SYS EXT DISTRIBUTOR</td> <td>1</td> <td>PZ</td> </tr> <tr> <td>VL1054B0</td> <td>ONE WASHING SYS INLET DISTRIBUTOR</td> <td>1</td> <td>PZ</td> </tr> <tr> <td>VL1128A0</td> <td>BARBED CHECK VALVE D6</td> <td>1</td> <td>PZ</td> </tr> <tr> <td>VM2172A0</td> <td>PUMP LOCKING CLIP</td> <td>1</td> <td>PZ</td> </tr> </tbody> </table> | Code | Description | Qty                          | UOM | RC1019A0 | D=10 ELASTIC CLAMP | 17                                  | PZ | RC1242A0 | D=10 CLOSED CAP | 2                                  | PZ | TB1818A0 | JG Ø8 BLUE PE PIPE | 0.320                          | M | TB2820A0 | PIPE EPDM FOR WASHING SYSTEM | 1.380                    | M | VI1220A1 | 4,2X12 TCB SELF-TAPPIN G SCREW | 1                  | PZ | VL1019A0 | VIBRATION PUMP | 2            | PZ | VL1053B0 | ONE WASHING SYS EXT DISTRIBUTOR | 1               | PZ | VL1054B0 | ONE WASHING SYS INLET DISTRIBUTOR | 1                     | PZ | VL1128A0 | BARBED CHECK VALVE D6 | 1 | PZ | VM2172A0 | PUMP LOCKING CLIP | 1 | PZ |
|           |   |   | Code       | Description                              | Qty   | UOM  |             |                              |     |          |                    |                                     |    |          |                 |                                    |    |          |                    |                                |   |          |                              |                          |   |          |                                |                    |    |          |                |              |    |          |                                 |                 |    |          |                                   |                       |    |          |                       |   |    |          |                   |   |    |
| RC1019A0  | D=10 ELASTIC CLAMP                        | 17  | PZ         |  |   |      |             |                              |     |          |                    |                                     |    |          |                 |                                    |    |          |                    |                                |   |          |                              |                          |   |          |                                |                    |    |          |                |              |    |          |                                 |                 |    |          |                                   |                       |    |          |                       |   |    |          |                   |   |    |
| RC1242A0  | D=10 CLOSED CAP                           | 2   | PZ         |  |   |      |             |                              |     |          |                    |                                     |    |          |                 |                                    |    |          |                    |                                |   |          |                              |                          |   |          |                                |                    |    |          |                |              |    |          |                                 |                 |    |          |                                   |                       |    |          |                       |   |    |          |                   |   |    |
| TB1818A0  | JG Ø8 BLUE PE PIPE                        | 0.320   | M          |  |   |      |             |                              |     |          |                    |                                     |    |          |                 |                                    |    |          |                    |                                |   |          |                              |                          |   |          |                                |                    |    |          |                |              |    |          |                                 |                 |    |          |                                   |                       |    |          |                       |   |    |          |                   |   |    |
| TB2820A0  | PIPE EPDM FOR WASHING SYSTEM              | 1.380   | M          |  |   |      |             |                              |     |          |                    |                                     |    |          |                 |                                    |    |          |                    |                                |   |          |                              |                          |   |          |                                |                    |    |          |                |              |    |          |                                 |                 |    |          |                                   |                       |    |          |                       |   |    |          |                   |   |    |
| VI1220A1  | 4,2X12 TCB SELF-TAPPIN G SCREW            | 1   | PZ         |  |   |      |             |                              |     |          |                    |                                     |    |          |                 |                                    |    |          |                    |                                |   |          |                              |                          |   |          |                                |                    |    |          |                |              |    |          |                                 |                 |    |          |                                   |                       |    |          |                       |   |    |          |                   |   |    |
| VL1019A0  | VIBRATION PUMP                            | 2   | PZ         |  |   |      |             |                              |     |          |                    |                                     |    |          |                 |                                    |    |          |                    |                                |   |          |                              |                          |   |          |                                |                    |    |          |                |              |    |          |                                 |                 |    |          |                                   |                       |    |          |                       |   |    |          |                   |   |    |
| VL1053B0  | ONE WASHING SYS EXT DISTRIBUTOR           | 1   | PZ         |  |   |      |             |                              |     |          |                    |                                     |    |          |                 |                                    |    |          |                    |                                |   |          |                              |                          |   |          |                                |                    |    |          |                |              |    |          |                                 |                 |    |          |                                   |                       |    |          |                       |   |    |          |                   |   |    |
| VL1054B0  | ONE WASHING SYS INLET DISTRIBUTOR         | 1   | PZ         |  |   |      |             |                              |     |          |                    |                                     |    |          |                 |                                    |    |          |                    |                                |   |          |                              |                          |   |          |                                |                    |    |          |                |              |    |          |                                 |                 |    |          |                                   |                       |    |          |                       |   |    |          |                   |   |    |
| VL1128A0  | BARBED CHECK VALVE D6                     | 1   | PZ         |  |   |      |             |                              |     |          |                    |                                     |    |          |                 |                                    |    |          |                    |                                |   |          |                              |                          |   |          |                                |                    |    |          |                |              |    |          |                                 |                 |    |          |                                   |                       |    |          |                       |   |    |          |                   |   |    |
| VM2172A0  | PUMP LOCKING CLIP                         | 1   | PZ         |  |   |      |             |                              |     |          |                    |                                     |    |          |                 |                                    |    |          |                    |                                |   |          |                              |                          |   |          |                                |                    |    |          |                |              |    |          |                                 |                 |    |          |                                   |                       |    |          |                       |   |    |          |                   |   |    |
| KVL1107A  | 04EU PLUS EUR 1 ROTOR CLEANING SYSTEM KIT | <table border="1"> <thead> <tr> <th>Code</th> <th>Description</th> <th>Qty</th> <th>UOM</th> </tr> </thead> <tbody> <tr> <td>0H7323A0</td> <td>WASHING SYSTEM HOLDING PLATE</td> <td>1</td> <td>PZ</td> </tr> <tr> <td>EL1252A1</td> <td>1 WAY WATER VALVE + J.G. CONNECTION</td> <td>1</td> <td>PZ</td> </tr> <tr> <td>EL1424A0</td> <td>D8 CONNECTION WATER SOLENOID VALVE</td> <td>1</td> <td>PZ</td> </tr> <tr> <td>EL1436A0</td> <td>H2O SOLENOID JG D8 CHECK VALVE</td> <td>1</td> <td>PZ</td> </tr> <tr> <td>GN1526A0</td> <td>INT. D.=6.9 TH=1.8 O-RIN</td> <td>1</td> <td>PZ</td> </tr> <tr> <td>RC1019A0</td> <td>D=10 ELASTIC CLAMP</td> <td>13</td> <td>PZ</td> </tr> <tr> <td>RC1130A0</td> <td>130X2,6 CLAM</td> <td>1</td> <td>PZ</td> </tr> <tr> <td>RC1242A0</td> <td>D=10 CLOSED CAP</td> <td>2</td> <td>PZ</td> </tr> <tr> <td>RC1310A0</td> <td>140X4 CLAMP WITH CLIP</td> <td>2</td> <td>PZ</td> </tr> </tbody> </table> | Code       | Description                              | Qty   | UOM  | 0H7323A0    | WASHING SYSTEM HOLDING PLATE | 1   | PZ       | EL1252A1           | 1 WAY WATER VALVE + J.G. CONNECTION | 1  | PZ       | EL1424A0        | D8 CONNECTION WATER SOLENOID VALVE | 1  | PZ       | EL1436A0           | H2O SOLENOID JG D8 CHECK VALVE | 1 | PZ       | GN1526A0                     | INT. D.=6.9 TH=1.8 O-RIN | 1 | PZ       | RC1019A0                       | D=10 ELASTIC CLAMP | 13 | PZ       | RC1130A0       | 130X2,6 CLAM | 1  | PZ       | RC1242A0                        | D=10 CLOSED CAP | 2  | PZ       | RC1310A0                          | 140X4 CLAMP WITH CLIP | 2  | PZ       |                       |   |    |          |                   |   |    |
| Code      | Description                               | Qty   | UOM        |  |   |      |             |                              |     |          |                    |                                     |    |          |                 |                                    |    |          |                    |                                |   |          |                              |                          |   |          |                                |                    |    |          |                |              |    |          |                                 |                 |    |          |                                   |                       |    |          |                       |   |    |          |                   |   |    |
| 0H7323A0  | WASHING SYSTEM HOLDING PLATE              | 1   | PZ         |  |   |      |             |                              |     |          |                    |                                     |    |          |                 |                                    |    |          |                    |                                |   |          |                              |                          |   |          |                                |                    |    |          |                |              |    |          |                                 |                 |    |          |                                   |                       |    |          |                       |   |    |          |                   |   |    |
| EL1252A1  | 1 WAY WATER VALVE + J.G. CONNECTION       | 1   | PZ         |  |   |      |             |                              |     |          |                    |                                     |    |          |                 |                                    |    |          |                    |                                |   |          |                              |                          |   |          |                                |                    |    |          |                |              |    |          |                                 |                 |    |          |                                   |                       |    |          |                       |   |    |          |                   |   |    |
| EL1424A0  | D8 CONNECTION WATER SOLENOID VALVE        | 1   | PZ         |  |   |      |             |                              |     |          |                    |                                     |    |          |                 |                                    |    |          |                    |                                |   |          |                              |                          |   |          |                                |                    |    |          |                |              |    |          |                                 |                 |    |          |                                   |                       |    |          |                       |   |    |          |                   |   |    |
| EL1436A0  | H2O SOLENOID JG D8 CHECK VALVE            | 1   | PZ         |  |   |      |             |                              |     |          |                    |                                     |    |          |                 |                                    |    |          |                    |                                |   |          |                              |                          |   |          |                                |                    |    |          |                |              |    |          |                                 |                 |    |          |                                   |                       |    |          |                       |   |    |          |                   |   |    |
| GN1526A0  | INT. D.=6.9 TH=1.8 O-RIN                  | 1   | PZ         |  |   |      |             |                              |     |          |                    |                                     |    |          |                 |                                    |    |          |                    |                                |   |          |                              |                          |   |          |                                |                    |    |          |                |              |    |          |                                 |                 |    |          |                                   |                       |    |          |                       |   |    |          |                   |   |    |
| RC1019A0  | D=10 ELASTIC CLAMP                        | 13  | PZ         |  |   |      |             |                              |     |          |                    |                                     |    |          |                 |                                    |    |          |                    |                                |   |          |                              |                          |   |          |                                |                    |    |          |                |              |    |          |                                 |                 |    |          |                                   |                       |    |          |                       |   |    |          |                   |   |    |
| RC1130A0  | 130X2,6 CLAM                              | 1   | PZ         |  |   |      |             |                              |     |          |                    |                                     |    |          |                 |                                    |    |          |                    |                                |   |          |                              |                          |   |          |                                |                    |    |          |                |              |    |          |                                 |                 |    |          |                                   |                       |    |          |                       |   |    |          |                   |   |    |
| RC1242A0  | D=10 CLOSED CAP                           | 2   | PZ         |  |   |      |             |                              |     |          |                    |                                     |    |          |                 |                                    |    |          |                    |                                |   |          |                              |                          |   |          |                                |                    |    |          |                |              |    |          |                                 |                 |    |          |                                   |                       |    |          |                       |   |    |          |                   |   |    |
| RC1310A0  | 140X4 CLAMP WITH CLIP                     | 2   | PZ         |  |   |      |             |                              |     |          |                    |                                     |    |          |                 |                                    |    |          |                    |                                |   |          |                              |                          |   |          |                                |                    |    |          |                |              |    |          |                                 |                 |    |          |                                   |                       |    |          |                       |   |    |          |                   |   |    |

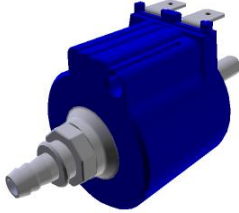
| COMPONENT |  |   | SPARE PART |   |  |      |             |  |     |          |  |   |    |          |                                    |                             |   |          |                                      |                    |    |          |                   |                                    |       |          |   |   |    |          |                                     |   |    |          |  |   |    |          |   |   |    |          |  |   |    |          |                             |   |    |          |                      |   |    |
|-----------|--|---|------------|---|--|------|-------------|--|-----|----------|--|---|----|----------|------------------------------------|-----------------------------|---|----------|--------------------------------------|--------------------|----|----------|-------------------|------------------------------------|-------|----------|---|---|----|----------|-------------------------------------|---|----|----------|--|---|----|----------|---|---|----|----------|--|---|----|----------|-----------------------------|---|----|----------|----------------------|---|----|
| Code      | Description  | Image   | Code       | Description                                     | Components list  |      |             |  |     |          |  |   |    |          |                                    |                             |   |          |                                      |                    |    |          |                   |                                    |       |          |   |   |    |          |                                     |   |    |          |  |   |    |          |   |   |    |          |  |   |    |          |                             |   |    |          |                      |   |    |
| VL1019A   | VIBRATION PUMP                                       |    | KVL1107A   | 04EU PLUS EUR<br>1 ROTOR CLEANING<br>SYSTEM KIT | <table border="1"> <thead> <tr> <th>Code</th> <th>Description</th> <th>Qty</th> <th>UOM</th> </tr> </thead> <tbody> <tr> <td>RC1356A0</td> <td>STRAIGHT<br/>THREADED<br/>FEMALE END<br/>8X1/4" BSP</td> <td>1</td> <td>PZ</td> </tr> <tr> <td>TB2820A0</td> <td>PIPE EPDM<br/>FOR WASHING<br/>SYSTEM</td> <td>2.670</td> <td>M</td> </tr> <tr> <td>VI1220A1</td> <td>4,2X12 TCB<br/>SELF-TAPPIN<br/>G SCREW</td> <td>2</td> <td>PZ</td> </tr> <tr> <td>VL1019A0</td> <td>VIBRATION<br/>PUMP</td> <td>1</td> <td>PZ</td> </tr> <tr> <td>VL1064A0</td> <td>WASHING<br/>SYSTEM<br/>OUTLETS<br/>DISTRIBUTOR</td> <td>1</td> <td>PZ</td> </tr> <tr> <td>VL1065A1</td> <td>1/4 MALE N.O.<br/>PRESSURE<br/>SWITCH</td> <td>1</td> <td>PZ</td> </tr> <tr> <td>VL1067A0</td> <td>WASHING<br/>SYSTEM<br/>INLETS<br/>DISTRIBUTOR</td> <td>1</td> <td>PZ</td> </tr> <tr> <td>VL1083A0</td> <td>D=10<br/>CONNECTION<br/>- D=6 PIPE<br/>FITTING</td> <td>1</td> <td>PZ</td> </tr> <tr> <td>VL1102A1</td> <td>DETERGENT<br/>LINE FILTER +<br/>BARBED VNR<br/>6 MM</td> <td>1</td> <td>PZ</td> </tr> <tr> <td>VL1128A0</td> <td>BARBED<br/>CHECK VALVE<br/>D6</td> <td>1</td> <td>PZ</td> </tr> <tr> <td>VM2172A0</td> <td>PUMP<br/>LOCKING CLIP</td> <td>1</td> <td>PZ</td> </tr> </tbody> </table> | Code | Description | Qty  | UOM | RC1356A0 | STRAIGHT<br>THREADED<br>FEMALE END<br>8X1/4" BSP | 1                                       | PZ | TB2820A0 | PIPE EPDM<br>FOR WASHING<br>SYSTEM | 2.670                       | M | VI1220A1 | 4,2X12 TCB<br>SELF-TAPPIN<br>G SCREW | 2                  | PZ | VL1019A0 | VIBRATION<br>PUMP | 1                                  | PZ    | VL1064A0 | WASHING<br>SYSTEM<br>OUTLETS<br>DISTRIBUTOR | 1 | PZ | VL1065A1 | 1/4 MALE N.O.<br>PRESSURE<br>SWITCH | 1 | PZ | VL1067A0 | WASHING<br>SYSTEM<br>INLETS<br>DISTRIBUTOR | 1 | PZ | VL1083A0 | D=10<br>CONNECTION<br>- D=6 PIPE<br>FITTING | 1 | PZ | VL1102A1 | DETERGENT<br>LINE FILTER +<br>BARBED VNR<br>6 MM | 1 | PZ | VL1128A0 | BARBED<br>CHECK VALVE<br>D6 | 1 | PZ | VM2172A0 | PUMP<br>LOCKING CLIP | 1 | PZ |
|           |  |   | Code       | Description                                     | Qty  | UOM  |             |  |     |          |  |   |    |          |                                    |                             |   |          |                                      |                    |    |          |                   |                                    |       |          |   |   |    |          |                                     |   |    |          |  |   |    |          |   |   |    |          |  |   |    |          |                             |   |    |          |                      |   |    |
| RC1356A0  | STRAIGHT<br>THREADED<br>FEMALE END<br>8X1/4" BSP     | 1   | PZ         |   |  |      |             |  |     |          |  |   |    |          |                                    |                             |   |          |                                      |                    |    |          |                   |                                    |       |          |   |   |    |          |                                     |   |    |          |  |   |    |          |   |   |    |          |  |   |    |          |                             |   |    |          |                      |   |    |
| TB2820A0  | PIPE EPDM<br>FOR WASHING<br>SYSTEM                   | 2.670   | M          |   |  |      |             |  |     |          |  |   |    |          |                                    |                             |   |          |                                      |                    |    |          |                   |                                    |       |          |   |   |    |          |                                     |   |    |          |  |   |    |          |   |   |    |          |  |   |    |          |                             |   |    |          |                      |   |    |
| VI1220A1  | 4,2X12 TCB<br>SELF-TAPPIN<br>G SCREW                 | 2   | PZ         |   |  |      |             |  |     |          |  |   |    |          |                                    |                             |   |          |                                      |                    |    |          |                   |                                    |       |          |   |   |    |          |                                     |   |    |          |  |   |    |          |   |   |    |          |  |   |    |          |                             |   |    |          |                      |   |    |
| VL1019A0  | VIBRATION<br>PUMP                                    | 1   | PZ         |   |  |      |             |  |     |          |  |   |    |          |                                    |                             |   |          |                                      |                    |    |          |                   |                                    |       |          |   |   |    |          |                                     |   |    |          |  |   |    |          |   |   |    |          |  |   |    |          |                             |   |    |          |                      |   |    |
| VL1064A0  | WASHING<br>SYSTEM<br>OUTLETS<br>DISTRIBUTOR          | 1   | PZ         |   |  |      |             |  |     |          |  |   |    |          |                                    |                             |   |          |                                      |                    |    |          |                   |                                    |       |          |   |   |    |          |                                     |   |    |          |  |   |    |          |   |   |    |          |  |   |    |          |                             |   |    |          |                      |   |    |
| VL1065A1  | 1/4 MALE N.O.<br>PRESSURE<br>SWITCH                  | 1   | PZ         |   |  |      |             |  |     |          |  |   |    |          |                                    |                             |   |          |                                      |                    |    |          |                   |                                    |       |          |   |   |    |          |                                     |   |    |          |  |   |    |          |   |   |    |          |  |   |    |          |                             |   |    |          |                      |   |    |
| VL1067A0  | WASHING<br>SYSTEM<br>INLETS<br>DISTRIBUTOR           | 1   | PZ         |   |  |      |             |  |     |          |  |   |    |          |                                    |                             |   |          |                                      |                    |    |          |                   |                                    |       |          |   |   |    |          |                                     |   |    |          |  |   |    |          |   |   |    |          |  |   |    |          |                             |   |    |          |                      |   |    |
| VL1083A0  | D=10<br>CONNECTION<br>- D=6 PIPE<br>FITTING          | 1   | PZ         |   |  |      |             |  |     |          |  |   |    |          |                                    |                             |   |          |                                      |                    |    |          |                   |                                    |       |          |   |   |    |          |                                     |   |    |          |  |   |    |          |   |   |    |          |  |   |    |          |                             |   |    |          |                      |   |    |
| VL1102A1  | DETERGENT<br>LINE FILTER +<br>BARBED VNR<br>6 MM     | 1   | PZ         |   |  |      |             |  |     |          |  |   |    |          |                                    |                             |   |          |                                      |                    |    |          |                   |                                    |       |          |   |   |    |          |                                     |   |    |          |  |   |    |          |   |   |    |          |  |   |    |          |                             |   |    |          |                      |   |    |
| VL1128A0  | BARBED<br>CHECK VALVE<br>D6                          | 1   | PZ         |   |  |      |             |  |     |          |  |   |    |          |                                    |                             |   |          |                                      |                    |    |          |                   |                                    |       |          |   |   |    |          |                                     |   |    |          |  |   |    |          |   |   |    |          |  |   |    |          |                             |   |    |          |                      |   |    |
| VM2172A0  | PUMP<br>LOCKING CLIP                                 | 1   | PZ         |   |  |      |             |  |     |          |  |   |    |          |                                    |                             |   |          |                                      |                    |    |          |                   |                                    |       |          |   |   |    |          |                                     |   |    |          |  |   |    |          |   |   |    |          |  |   |    |          |                             |   |    |          |                      |   |    |
| KVL1106A  | EUR 1 ROTOR ARM<br>ONE CLEANING<br>SYSTEM KIT        | <table border="1"> <thead> <tr> <th>Code</th> <th>Description</th> <th>Qty</th> <th>UOM</th> </tr> </thead> <tbody> <tr> <td>0H7819A0</td> <td>ONE<br/>WASHING SYS<br/>SUPPORT<br/>WITH STEAM<br/>VALVE</td> <td>1</td> <td>PZ</td> </tr> <tr> <td>EL1436A0</td> <td>H2O<br/>SOLENOID JG<br/>D8 CHECK<br/>VALVE</td> <td>1</td> <td>PZ</td> </tr> <tr> <td>GN1526A0</td> <td>INT. D.=6.9<br/>TH=1.8 O-RIN</td> <td>1</td> <td>PZ</td> </tr> <tr> <td>RC1242A0</td> <td>D=10 CLOSED<br/>CAP</td> <td>2</td> <td>PZ</td> </tr> <tr> <td>TB2820A0</td> <td>PIPE EPDM<br/>FOR WASHING<br/>SYSTEM</td> <td>1.420</td> <td>M</td> </tr> </tbody> </table> | Code       | Description                                     | Qty  | UOM  | 0H7819A0    | ONE<br>WASHING SYS<br>SUPPORT<br>WITH STEAM<br>VALVE | 1   | PZ       | EL1436A0   | H2O<br>SOLENOID JG<br>D8 CHECK<br>VALVE | 1  | PZ       | GN1526A0                           | INT. D.=6.9<br>TH=1.8 O-RIN | 1 | PZ       | RC1242A0                             | D=10 CLOSED<br>CAP | 2  | PZ       | TB2820A0          | PIPE EPDM<br>FOR WASHING<br>SYSTEM | 1.420 | M        |   |   |    |          |                                     |   |    |          |  |   |    |          |   |   |    |          |  |   |    |          |                             |   |    |          |                      |   |    |
| Code      | Description  | Qty   | UOM        |   |  |      |             |  |     |          |  |   |    |          |                                    |                             |   |          |                                      |                    |    |          |                   |                                    |       |          |   |   |    |          |                                     |   |    |          |  |   |    |          |   |   |    |          |  |   |    |          |                             |   |    |          |                      |   |    |
| 0H7819A0  | ONE<br>WASHING SYS<br>SUPPORT<br>WITH STEAM<br>VALVE | 1   | PZ         |   |  |      |             |  |     |          |  |   |    |          |                                    |                             |   |          |                                      |                    |    |          |                   |                                    |       |          |   |   |    |          |                                     |   |    |          |  |   |    |          |   |   |    |          |  |   |    |          |                             |   |    |          |                      |   |    |
| EL1436A0  | H2O<br>SOLENOID JG<br>D8 CHECK<br>VALVE              | 1   | PZ         |   |  |      |             |  |     |          |  |   |    |          |                                    |                             |   |          |                                      |                    |    |          |                   |                                    |       |          |   |   |    |          |                                     |   |    |          |  |   |    |          |   |   |    |          |  |   |    |          |                             |   |    |          |                      |   |    |
| GN1526A0  | INT. D.=6.9<br>TH=1.8 O-RIN                          | 1   | PZ         |   |  |      |             |  |     |          |  |   |    |          |                                    |                             |   |          |                                      |                    |    |          |                   |                                    |       |          |   |   |    |          |                                     |   |    |          |  |   |    |          |   |   |    |          |  |   |    |          |                             |   |    |          |                      |   |    |
| RC1242A0  | D=10 CLOSED<br>CAP                                   | 2   | PZ         |   |  |      |             |  |     |          |  |   |    |          |                                    |                             |   |          |                                      |                    |    |          |                   |                                    |       |          |   |   |    |          |                                     |   |    |          |  |   |    |          |   |   |    |          |  |   |    |          |                             |   |    |          |                      |   |    |
| TB2820A0  | PIPE EPDM<br>FOR WASHING<br>SYSTEM                   | 1.420   | M          |   |  |      |             |  |     |          |  |   |    |          |                                    |                             |   |          |                                      |                    |    |          |                   |                                    |       |          |   |   |    |          |                                     |   |    |          |  |   |    |          |   |   |    |          |  |   |    |          |                             |   |    |          |                      |   |    |

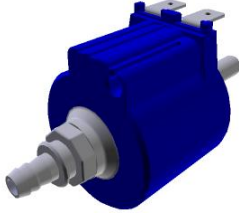
| COMPONENT |  |   | SPARE PART |   |  |      |             |  |     |          |                                      |   |    |          |                   |  |    |          |  |  |    |          |  |                             |    |          |  |                       |    |          |                             |              |    |          |                      |                    |    |    |          |  |   |    |
|-----------|--|---|------------|---|--|------|-------------|--|-----|----------|--------------------------------------|---|----|----------|-------------------|--|----|----------|--|--|----|----------|--|-----------------------------|----|----------|--|-----------------------|----|----------|-----------------------------|--------------|----|----------|----------------------|--------------------|----|----|----------|--|---|----|
| Code      | Description  | Image   | Code       | Description                                   | Components list  |      |             |  |     |          |                                      |   |    |          |                   |  |    |          |  |  |    |          |  |                             |    |          |  |                       |    |          |                             |              |    |          |                      |                    |    |    |          |  |   |    |
| VL1019A   | VIBRATION PUMP                                       |    | KVL1106A   | EUR 1 ROTOR ARM<br>ONE CLEANING<br>SYSTEM KIT | <table border="1"> <thead> <tr> <th>Code</th> <th>Description</th> <th>Qty</th> <th>UOM</th> </tr> </thead> <tbody> <tr> <td>VI1220A1</td> <td>4,2X12 TCB<br/>SELF-TAPPIN<br/>G SCREW</td> <td>1</td> <td>PZ</td> </tr> <tr> <td>VL1019A0</td> <td>VIBRATION<br/>PUMP</td> <td>1</td> <td>PZ</td> </tr> <tr> <td>VL1053B0</td> <td>ONE<br/>WASHING SYS<br/>EXT<br/>DISTRIBUTOR</td> <td>1</td> <td>PZ</td> </tr> <tr> <td>VL1054B0</td> <td>ONE<br/>WASHING SYS<br/>INLET<br/>DISTRIBUTOR</td> <td>1</td> <td>PZ</td> </tr> <tr> <td>VL1102A1</td> <td>DETERGENT<br/>LINE FILTER +<br/>BARBED VNR<br/>6 MM</td> <td>1</td> <td>PZ</td> </tr> <tr> <td>VL1128A0</td> <td>BARBED<br/>CHECK VALVE<br/>D6</td> <td>1</td> <td>PZ</td> </tr> <tr> <td>VM2172A0</td> <td>PUMP<br/>LOCKING CLIP</td> <td>1</td> <td>PZ</td> </tr> </tbody> </table> | Code | Description | Qty  | UOM | VI1220A1 | 4,2X12 TCB<br>SELF-TAPPIN<br>G SCREW | 1   | PZ | VL1019A0 | VIBRATION<br>PUMP | 1  | PZ | VL1053B0 | ONE<br>WASHING SYS<br>EXT<br>DISTRIBUTOR | 1  | PZ | VL1054B0 | ONE<br>WASHING SYS<br>INLET<br>DISTRIBUTOR | 1                           | PZ | VL1102A1 | DETERGENT<br>LINE FILTER +<br>BARBED VNR<br>6 MM | 1                     | PZ | VL1128A0 | BARBED<br>CHECK VALVE<br>D6 | 1            | PZ | VM2172A0 | PUMP<br>LOCKING CLIP | 1                  | PZ |    |          |  |   |    |
|           |  |   | Code       | Description                                   | Qty  | UOM  |             |  |     |          |                                      |   |    |          |                   |  |    |          |  |  |    |          |  |                             |    |          |  |                       |    |          |                             |              |    |          |                      |                    |    |    |          |  |   |    |
| VI1220A1  | 4,2X12 TCB<br>SELF-TAPPIN<br>G SCREW                 | 1   | PZ         |   |  |      |             |  |     |          |                                      |   |    |          |                   |  |    |          |  |  |    |          |  |                             |    |          |  |                       |    |          |                             |              |    |          |                      |                    |    |    |          |  |   |    |
| VL1019A0  | VIBRATION<br>PUMP                                    | 1   | PZ         |   |  |      |             |  |     |          |                                      |   |    |          |                   |  |    |          |  |  |    |          |  |                             |    |          |  |                       |    |          |                             |              |    |          |                      |                    |    |    |          |  |   |    |
| VL1053B0  | ONE<br>WASHING SYS<br>EXT<br>DISTRIBUTOR             | 1   | PZ         |   |  |      |             |  |     |          |                                      |   |    |          |                   |  |    |          |  |  |    |          |  |                             |    |          |  |                       |    |          |                             |              |    |          |                      |                    |    |    |          |  |   |    |
| VL1054B0  | ONE<br>WASHING SYS<br>INLET<br>DISTRIBUTOR           | 1   | PZ         |   |  |      |             |  |     |          |                                      |   |    |          |                   |  |    |          |  |  |    |          |  |                             |    |          |  |                       |    |          |                             |              |    |          |                      |                    |    |    |          |  |   |    |
| VL1102A1  | DETERGENT<br>LINE FILTER +<br>BARBED VNR<br>6 MM     | 1   | PZ         |   |  |      |             |  |     |          |                                      |   |    |          |                   |  |    |          |  |  |    |          |  |                             |    |          |  |                       |    |          |                             |              |    |          |                      |                    |    |    |          |  |   |    |
| VL1128A0  | BARBED<br>CHECK VALVE<br>D6                          | 1   | PZ         |   |  |      |             |  |     |          |                                      |   |    |          |                   |  |    |          |  |  |    |          |  |                             |    |          |  |                       |    |          |                             |              |    |          |                      |                    |    |    |          |  |   |    |
| VM2172A0  | PUMP<br>LOCKING CLIP                                 | 1   | PZ         |   |  |      |             |  |     |          |                                      |   |    |          |                   |  |    |          |  |  |    |          |  |                             |    |          |  |                       |    |          |                             |              |    |          |                      |                    |    |    |          |  |   |    |
| KVL1105A  | USA 2 ROTOR ARMS<br>PLUS CLEANING<br>SYSTEM KIT      | <table border="1"> <thead> <tr> <th>Code</th> <th>Description</th> <th>Qty</th> <th>UOM</th> </tr> </thead> <tbody> <tr> <td>0H7820A0</td> <td>PLUS<br/>WASHING SY<br/>SUPPORT<br/>WITH STEAM<br/>VALVE</td> <td>1</td> <td>PZ</td> </tr> <tr> <td>EL1422A1</td> <td>1 WAY<br/>SOLENOID<br/>VALVE +<br/>D8-D10<br/>REDUCTION</td> <td>1</td> <td>PZ</td> </tr> <tr> <td>EL1426A0</td> <td>H2O UL<br/>SOLENOID JG<br/>D8-PIPE<br/>HOLDER</td> <td>2</td> <td>PZ</td> </tr> <tr> <td>EL1437A0</td> <td>H2O<br/>SOLENOID JG<br/>D6 UL CHECK<br/>VALVE</td> <td>1</td> <td>PZ</td> </tr> <tr> <td>GN1526A0</td> <td>INT. D.=6.9<br/>TH=1.8 O-RIN</td> <td>1</td> <td>PZ</td> </tr> <tr> <td>RC1019A0</td> <td>D=10 ELASTIC<br/>CLAMP</td> <td>12</td> <td>PZ</td> </tr> <tr> <td>RC1130A0</td> <td>130X2,6 CLAM</td> <td>1</td> <td>PZ</td> </tr> <tr> <td>RC1242A0</td> <td>D=10 CLOSED<br/>CAP</td> <td>2</td> <td>PZ</td> </tr> <tr> <td>RC1356A0</td> <td>STRAIGHT<br/>THREADED<br/>FEMALE END<br/>8X1/4" BSP</td> <td>1</td> <td>PZ</td> </tr> </tbody> </table> | Code       | Description                                   | Qty  | UOM  | 0H7820A0    | PLUS<br>WASHING SY<br>SUPPORT<br>WITH STEAM<br>VALVE | 1   | PZ       | EL1422A1                             | 1 WAY<br>SOLENOID<br>VALVE +<br>D8-D10<br>REDUCTION | 1  | PZ       | EL1426A0          | H2O UL<br>SOLENOID JG<br>D8-PIPE<br>HOLDER | 2  | PZ       | EL1437A0                                 | H2O<br>SOLENOID JG<br>D6 UL CHECK<br>VALVE | 1  | PZ       | GN1526A0                                   | INT. D.=6.9<br>TH=1.8 O-RIN | 1  | PZ       | RC1019A0   | D=10 ELASTIC<br>CLAMP | 12 | PZ       | RC1130A0                    | 130X2,6 CLAM | 1  | PZ       | RC1242A0             | D=10 CLOSED<br>CAP | 2  | PZ | RC1356A0 | STRAIGHT<br>THREADED<br>FEMALE END<br>8X1/4" BSP | 1 | PZ |
| Code      | Description  | Qty   | UOM        |   |  |      |             |  |     |          |                                      |   |    |          |                   |  |    |          |  |  |    |          |  |                             |    |          |  |                       |    |          |                             |              |    |          |                      |                    |    |    |          |  |   |    |
| 0H7820A0  | PLUS<br>WASHING SY<br>SUPPORT<br>WITH STEAM<br>VALVE | 1   | PZ         |   |  |      |             |  |     |          |                                      |   |    |          |                   |  |    |          |  |  |    |          |  |                             |    |          |  |                       |    |          |                             |              |    |          |                      |                    |    |    |          |  |   |    |
| EL1422A1  | 1 WAY<br>SOLENOID<br>VALVE +<br>D8-D10<br>REDUCTION  | 1   | PZ         |   |  |      |             |  |     |          |                                      |   |    |          |                   |  |    |          |  |  |    |          |  |                             |    |          |  |                       |    |          |                             |              |    |          |                      |                    |    |    |          |  |   |    |
| EL1426A0  | H2O UL<br>SOLENOID JG<br>D8-PIPE<br>HOLDER           | 2   | PZ         |   |  |      |             |  |     |          |                                      |   |    |          |                   |  |    |          |  |  |    |          |  |                             |    |          |  |                       |    |          |                             |              |    |          |                      |                    |    |    |          |  |   |    |
| EL1437A0  | H2O<br>SOLENOID JG<br>D6 UL CHECK<br>VALVE           | 1   | PZ         |   |  |      |             |  |     |          |                                      |   |    |          |                   |  |    |          |  |  |    |          |  |                             |    |          |  |                       |    |          |                             |              |    |          |                      |                    |    |    |          |  |   |    |
| GN1526A0  | INT. D.=6.9<br>TH=1.8 O-RIN                          | 1   | PZ         |   |  |      |             |  |     |          |                                      |   |    |          |                   |  |    |          |  |  |    |          |  |                             |    |          |  |                       |    |          |                             |              |    |          |                      |                    |    |    |          |  |   |    |
| RC1019A0  | D=10 ELASTIC<br>CLAMP                                | 12  | PZ         |   |  |      |             |  |     |          |                                      |   |    |          |                   |  |    |          |  |  |    |          |  |                             |    |          |  |                       |    |          |                             |              |    |          |                      |                    |    |    |          |  |   |    |
| RC1130A0  | 130X2,6 CLAM   | 1   | PZ         |   |  |      |             |  |     |          |                                      |   |    |          |                   |  |    |          |  |  |    |          |  |                             |    |          |  |                       |    |          |                             |              |    |          |                      |                    |    |    |          |  |   |    |
| RC1242A0  | D=10 CLOSED<br>CAP                                   | 2   | PZ         |   |  |      |             |  |     |          |                                      |   |    |          |                   |  |    |          |  |  |    |          |  |                             |    |          |  |                       |    |          |                             |              |    |          |                      |                    |    |    |          |  |   |    |
| RC1356A0  | STRAIGHT<br>THREADED<br>FEMALE END<br>8X1/4" BSP     | 1   | PZ         |   |  |      |             |  |     |          |                                      |   |    |          |                   |  |    |          |  |  |    |          |  |                             |    |          |  |                       |    |          |                             |              |    |          |                      |                    |    |    |          |  |   |    |

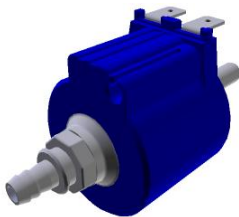

| COMPONENT |  |  | SPARE PART |   |  |      |             |  |     |          |                              |   |   |          |                               |                                   |    |          |                |                                   |    |          |                               |                           |    |          |                                   |                    |    |          |  |              |    |          |   |   |    |          |                       |   |    |          |                   |   |    |
|-----------|--|--|------------|---|--|------|-------------|--|-----|----------|------------------------------|---|---|----------|-------------------------------|-----------------------------------|----|----------|----------------|-----------------------------------|----|----------|-------------------------------|---------------------------|----|----------|-----------------------------------|--------------------|----|----------|--|--------------|----|----------|---|---|----|----------|-----------------------|---|----|----------|-------------------|---|----|
| Code      | Description                              | Image  | Code       | Description                               | Components list  |      |             |  |     |          |                              |   |   |          |                               |                                   |    |          |                |                                   |    |          |                               |                           |    |          |                                   |                    |    |          |  |              |    |          |   |   |    |          |                       |   |    |          |                   |   |    |
| VL1019A   | VIBRATION PUMP                           |   | KVL1105A   | USA 2 ROTOR ARMS PLUS CLEANING SYSTEM KIT | <table border="1"> <thead> <tr> <th>Code</th> <th>Description</th> <th>Qty</th> <th>UOM</th> </tr> </thead> <tbody> <tr> <td>TB2820A0</td> <td>PIPE EPDM FOR WASHING SYSTEM</td> <td>1.410</td> <td>M</td> </tr> <tr> <td>VI1220A1</td> <td>4,2X12 TCB SELF-TAPPING SCREW</td> <td>3</td> <td>PZ</td> </tr> <tr> <td>VL1019A0</td> <td>VIBRATION PUMP</td> <td>1</td> <td>PZ</td> </tr> <tr> <td>VL1065A1</td> <td>1/4 MALE N.O. PRESSURE SWITCH</td> <td>1</td> <td>PZ</td> </tr> <tr> <td>VL1067A0</td> <td>WASHING SYSTEM INLETS DISTRIBUTOR</td> <td>1</td> <td>PZ</td> </tr> <tr> <td>VL1092A0</td> <td>WASHING SYSTEM OUTLET DOUBLE DISTRIBUTOR</td> <td>1</td> <td>PZ</td> </tr> <tr> <td>VL1102A1</td> <td>DETERGENT LINE FILTER + BARBED VNR 6 MM</td> <td>1</td> <td>PZ</td> </tr> <tr> <td>VL1128A0</td> <td>BARBED CHECK VALVE D6</td> <td>1</td> <td>PZ</td> </tr> <tr> <td>VM2172A0</td> <td>PUMP LOCKING CLIP</td> <td>1</td> <td>PZ</td> </tr> </tbody> </table> | Code | Description | Qty                                      | UOM | TB2820A0 | PIPE EPDM FOR WASHING SYSTEM | 1.410                                   | M | VI1220A1 | 4,2X12 TCB SELF-TAPPING SCREW | 3                                 | PZ | VL1019A0 | VIBRATION PUMP | 1                                 | PZ | VL1065A1 | 1/4 MALE N.O. PRESSURE SWITCH | 1                         | PZ | VL1067A0 | WASHING SYSTEM INLETS DISTRIBUTOR | 1                  | PZ | VL1092A0 | WASHING SYSTEM OUTLET DOUBLE DISTRIBUTOR | 1            | PZ | VL1102A1 | DETERGENT LINE FILTER + BARBED VNR 6 MM | 1 | PZ | VL1128A0 | BARBED CHECK VALVE D6 | 1 | PZ | VM2172A0 | PUMP LOCKING CLIP | 1 | PZ |
|           |  |  | Code       | Description                               | Qty  | UOM  |             |  |     |          |                              |   |   |          |                               |                                   |    |          |                |                                   |    |          |                               |                           |    |          |                                   |                    |    |          |  |              |    |          |   |   |    |          |                       |   |    |          |                   |   |    |
| TB2820A0  | PIPE EPDM FOR WASHING SYSTEM             | 1.410  | M          |   |  |      |             |  |     |          |                              |   |   |          |                               |                                   |    |          |                |                                   |    |          |                               |                           |    |          |                                   |                    |    |          |  |              |    |          |   |   |    |          |                       |   |    |          |                   |   |    |
| VI1220A1  | 4,2X12 TCB SELF-TAPPING SCREW            | 3  | PZ         |   |  |      |             |  |     |          |                              |   |   |          |                               |                                   |    |          |                |                                   |    |          |                               |                           |    |          |                                   |                    |    |          |  |              |    |          |   |   |    |          |                       |   |    |          |                   |   |    |
| VL1019A0  | VIBRATION PUMP                           | 1  | PZ         |   |  |      |             |  |     |          |                              |   |   |          |                               |                                   |    |          |                |                                   |    |          |                               |                           |    |          |                                   |                    |    |          |  |              |    |          |   |   |    |          |                       |   |    |          |                   |   |    |
| VL1065A1  | 1/4 MALE N.O. PRESSURE SWITCH            | 1  | PZ         |   |  |      |             |  |     |          |                              |   |   |          |                               |                                   |    |          |                |                                   |    |          |                               |                           |    |          |                                   |                    |    |          |  |              |    |          |   |   |    |          |                       |   |    |          |                   |   |    |
| VL1067A0  | WASHING SYSTEM INLETS DISTRIBUTOR        | 1  | PZ         |   |  |      |             |  |     |          |                              |   |   |          |                               |                                   |    |          |                |                                   |    |          |                               |                           |    |          |                                   |                    |    |          |  |              |    |          |   |   |    |          |                       |   |    |          |                   |   |    |
| VL1092A0  | WASHING SYSTEM OUTLET DOUBLE DISTRIBUTOR | 1  | PZ         |   |  |      |             |  |     |          |                              |   |   |          |                               |                                   |    |          |                |                                   |    |          |                               |                           |    |          |                                   |                    |    |          |  |              |    |          |   |   |    |          |                       |   |    |          |                   |   |    |
| VL1102A1  | DETERGENT LINE FILTER + BARBED VNR 6 MM  | 1  | PZ         |   |  |      |             |  |     |          |                              |   |   |          |                               |                                   |    |          |                |                                   |    |          |                               |                           |    |          |                                   |                    |    |          |  |              |    |          |   |   |    |          |                       |   |    |          |                   |   |    |
| VL1128A0  | BARBED CHECK VALVE D6                    | 1  | PZ         |   |  |      |             |  |     |          |                              |   |   |          |                               |                                   |    |          |                |                                   |    |          |                               |                           |    |          |                                   |                    |    |          |  |              |    |          |   |   |    |          |                       |   |    |          |                   |   |    |
| VM2172A0  | PUMP LOCKING CLIP                        | 1  | PZ         |   |  |      |             |  |     |          |                              |   |   |          |                               |                                   |    |          |                |                                   |    |          |                               |                           |    |          |                                   |                    |    |          |  |              |    |          |   |   |    |          |                       |   |    |          |                   |   |    |
| KVL1104A  | USA 1 ROTOR ARM PLUS CLEANING SYSTEM KIT | <table border="1"> <thead> <tr> <th>Code</th> <th>Description</th> <th>Qty</th> <th>UOM</th> </tr> </thead> <tbody> <tr> <td>0H7820A0</td> <td>PLUS WASHING SY SUPPORT WITH STEAM VALVE</td> <td>1</td> <td>PZ</td> </tr> <tr> <td>EL1422A1</td> <td>1 WAY SOLENOID VALVE + D8-D10 REDUCTION</td> <td>1</td> <td>PZ</td> </tr> <tr> <td>EL1426A0</td> <td>H2O UL SOLENOID JG D8-PIPE HOLDER</td> <td>1</td> <td>PZ</td> </tr> <tr> <td>EL1437A0</td> <td>H2O SOLENOID JG D6 UL CHECK VALVE</td> <td>1</td> <td>PZ</td> </tr> <tr> <td>GN1526A0</td> <td>INT. D.=6.9 TH=1.8 O-RING</td> <td>1</td> <td>PZ</td> </tr> <tr> <td>RC1019A0</td> <td>D=10 ELASTIC CLAMP</td> <td>12</td> <td>PZ</td> </tr> <tr> <td>RC1130A0</td> <td>130X2,6 CLAM</td> <td>1</td> <td>PZ</td> </tr> </tbody> </table> | Code       | Description                               | Qty  | UOM  | 0H7820A0    | PLUS WASHING SY SUPPORT WITH STEAM VALVE | 1   | PZ       | EL1422A1                     | 1 WAY SOLENOID VALVE + D8-D10 REDUCTION | 1 | PZ       | EL1426A0                      | H2O UL SOLENOID JG D8-PIPE HOLDER | 1  | PZ       | EL1437A0       | H2O SOLENOID JG D6 UL CHECK VALVE | 1  | PZ       | GN1526A0                      | INT. D.=6.9 TH=1.8 O-RING | 1  | PZ       | RC1019A0                          | D=10 ELASTIC CLAMP | 12 | PZ       | RC1130A0                                 | 130X2,6 CLAM | 1  | PZ       |   |   |    |          |                       |   |    |          |                   |   |    |
| Code      | Description                              | Qty  | UOM        |   |  |      |             |  |     |          |                              |   |   |          |                               |                                   |    |          |                |                                   |    |          |                               |                           |    |          |                                   |                    |    |          |  |              |    |          |   |   |    |          |                       |   |    |          |                   |   |    |
| 0H7820A0  | PLUS WASHING SY SUPPORT WITH STEAM VALVE | 1  | PZ         |   |  |      |             |  |     |          |                              |   |   |          |                               |                                   |    |          |                |                                   |    |          |                               |                           |    |          |                                   |                    |    |          |  |              |    |          |   |   |    |          |                       |   |    |          |                   |   |    |
| EL1422A1  | 1 WAY SOLENOID VALVE + D8-D10 REDUCTION  | 1  | PZ         |   |  |      |             |  |     |          |                              |   |   |          |                               |                                   |    |          |                |                                   |    |          |                               |                           |    |          |                                   |                    |    |          |  |              |    |          |   |   |    |          |                       |   |    |          |                   |   |    |
| EL1426A0  | H2O UL SOLENOID JG D8-PIPE HOLDER        | 1  | PZ         |   |  |      |             |  |     |          |                              |   |   |          |                               |                                   |    |          |                |                                   |    |          |                               |                           |    |          |                                   |                    |    |          |  |              |    |          |   |   |    |          |                       |   |    |          |                   |   |    |
| EL1437A0  | H2O SOLENOID JG D6 UL CHECK VALVE        | 1  | PZ         |   |  |      |             |  |     |          |                              |   |   |          |                               |                                   |    |          |                |                                   |    |          |                               |                           |    |          |                                   |                    |    |          |  |              |    |          |   |   |    |          |                       |   |    |          |                   |   |    |
| GN1526A0  | INT. D.=6.9 TH=1.8 O-RING                | 1  | PZ         |   |  |      |             |  |     |          |                              |   |   |          |                               |                                   |    |          |                |                                   |    |          |                               |                           |    |          |                                   |                    |    |          |  |              |    |          |   |   |    |          |                       |   |    |          |                   |   |    |
| RC1019A0  | D=10 ELASTIC CLAMP                       | 12   | PZ         |   |  |      |             |  |     |          |                              |   |   |          |                               |                                   |    |          |                |                                   |    |          |                               |                           |    |          |                                   |                    |    |          |  |              |    |          |   |   |    |          |                       |   |    |          |                   |   |    |
| RC1130A0  | 130X2,6 CLAM                             | 1  | PZ         |   |  |      |             |  |     |          |                              |   |   |          |                               |                                   |    |          |                |                                   |    |          |                               |                           |    |          |                                   |                    |    |          |  |              |    |          |   |   |    |          |                       |   |    |          |                   |   |    |

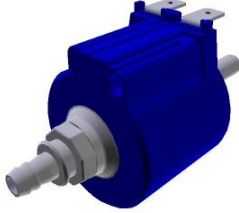
| COMPONENT |   |  | SPARE PART |  |   |      |             |  |     |          |                 |                                     |    |          |   |                                    |    |          |                              |                                |   |          |                                |                          |    |          |                |   |    |          |                                    |   |    |          |                               |   |    |          |                                   |   |    |          |   |   |    |          |                       |   |    |          |                   |   |    |
|-----------|---|--|------------|--|---|------|-------------|--|-----|----------|-----------------|-------------------------------------|----|----------|---|------------------------------------|----|----------|------------------------------|--------------------------------|---|----------|--------------------------------|--------------------------|----|----------|----------------|---|----|----------|------------------------------------|---|----|----------|-------------------------------|---|----|----------|-----------------------------------|---|----|----------|---|---|----|----------|-----------------------|---|----|----------|-------------------|---|----|
| Code      | Description                               | Image  | Code       | Description                              | Components list   |      |             |  |     |          |                 |                                     |    |          |   |                                    |    |          |                              |                                |   |          |                                |                          |    |          |                |   |    |          |                                    |   |    |          |                               |   |    |          |                                   |   |    |          |   |   |    |          |                       |   |    |          |                   |   |    |
| VL1019A   | VIBRATION PUMP                            |   | KVL1104A   | USA 1 ROTOR ARM PLUS CLEANING SYSTEM KIT | <table border="1"> <thead> <tr> <th>Code</th> <th>Description</th> <th>Qty</th> <th>UOM</th> </tr> </thead> <tbody> <tr> <td>RC1242A0</td> <td>D=10 CLOSED CAP</td> <td>2</td> <td>PZ</td> </tr> <tr> <td>RC1356A0</td> <td>STRAIGHT THREADED FEMALE END 8X1/4" BSP</td> <td>1</td> <td>PZ</td> </tr> <tr> <td>TB2820A0</td> <td>PIPE EPDM FOR WASHING SYSTEM</td> <td>1.410</td> <td>M</td> </tr> <tr> <td>VI1220A1</td> <td>4,2X12 TCB SELF-TAPPIN G SCREW</td> <td>3</td> <td>PZ</td> </tr> <tr> <td>VL1019A0</td> <td>VIBRATION PUMP</td> <td>1</td> <td>PZ</td> </tr> <tr> <td>VL1064A0</td> <td>WASHING SYSTEM OUTLETS DISTRIBUTOR</td> <td>1</td> <td>PZ</td> </tr> <tr> <td>VL1065A1</td> <td>1/4 MALE N.O. PRESSURE SWITCH</td> <td>1</td> <td>PZ</td> </tr> <tr> <td>VL1067A0</td> <td>WASHING SYSTEM INLETS DISTRIBUTOR</td> <td>1</td> <td>PZ</td> </tr> <tr> <td>VL1102A1</td> <td>DETERGENT LINE FILTER + BARBED VNR 6 MM</td> <td>1</td> <td>PZ</td> </tr> <tr> <td>VL1128A0</td> <td>BARBED CHECK VALVE D6</td> <td>1</td> <td>PZ</td> </tr> <tr> <td>VM2172A0</td> <td>PUMP LOCKING CLIP</td> <td>1</td> <td>PZ</td> </tr> </tbody> </table> | Code | Description | Qty                                      | UOM | RC1242A0 | D=10 CLOSED CAP | 2                                   | PZ | RC1356A0 | STRAIGHT THREADED FEMALE END 8X1/4" BSP | 1                                  | PZ | TB2820A0 | PIPE EPDM FOR WASHING SYSTEM | 1.410                          | M | VI1220A1 | 4,2X12 TCB SELF-TAPPIN G SCREW | 3                        | PZ | VL1019A0 | VIBRATION PUMP | 1 | PZ | VL1064A0 | WASHING SYSTEM OUTLETS DISTRIBUTOR | 1 | PZ | VL1065A1 | 1/4 MALE N.O. PRESSURE SWITCH | 1 | PZ | VL1067A0 | WASHING SYSTEM INLETS DISTRIBUTOR | 1 | PZ | VL1102A1 | DETERGENT LINE FILTER + BARBED VNR 6 MM | 1 | PZ | VL1128A0 | BARBED CHECK VALVE D6 | 1 | PZ | VM2172A0 | PUMP LOCKING CLIP | 1 | PZ |
|           |   |  | Code       | Description                              | Qty   | UOM  |             |  |     |          |                 |                                     |    |          |   |                                    |    |          |                              |                                |   |          |                                |                          |    |          |                |   |    |          |                                    |   |    |          |                               |   |    |          |                                   |   |    |          |   |   |    |          |                       |   |    |          |                   |   |    |
| RC1242A0  | D=10 CLOSED CAP                           | 2  | PZ         |  |   |      |             |  |     |          |                 |                                     |    |          |   |                                    |    |          |                              |                                |   |          |                                |                          |    |          |                |   |    |          |                                    |   |    |          |                               |   |    |          |                                   |   |    |          |   |   |    |          |                       |   |    |          |                   |   |    |
| RC1356A0  | STRAIGHT THREADED FEMALE END 8X1/4" BSP   | 1  | PZ         |  |   |      |             |  |     |          |                 |                                     |    |          |   |                                    |    |          |                              |                                |   |          |                                |                          |    |          |                |   |    |          |                                    |   |    |          |                               |   |    |          |                                   |   |    |          |   |   |    |          |                       |   |    |          |                   |   |    |
| TB2820A0  | PIPE EPDM FOR WASHING SYSTEM              | 1.410  | M          |  |   |      |             |  |     |          |                 |                                     |    |          |   |                                    |    |          |                              |                                |   |          |                                |                          |    |          |                |   |    |          |                                    |   |    |          |                               |   |    |          |                                   |   |    |          |   |   |    |          |                       |   |    |          |                   |   |    |
| VI1220A1  | 4,2X12 TCB SELF-TAPPIN G SCREW            | 3  | PZ         |  |   |      |             |  |     |          |                 |                                     |    |          |   |                                    |    |          |                              |                                |   |          |                                |                          |    |          |                |   |    |          |                                    |   |    |          |                               |   |    |          |                                   |   |    |          |   |   |    |          |                       |   |    |          |                   |   |    |
| VL1019A0  | VIBRATION PUMP                            | 1  | PZ         |  |   |      |             |  |     |          |                 |                                     |    |          |   |                                    |    |          |                              |                                |   |          |                                |                          |    |          |                |   |    |          |                                    |   |    |          |                               |   |    |          |                                   |   |    |          |   |   |    |          |                       |   |    |          |                   |   |    |
| VL1064A0  | WASHING SYSTEM OUTLETS DISTRIBUTOR        | 1  | PZ         |  |   |      |             |  |     |          |                 |                                     |    |          |   |                                    |    |          |                              |                                |   |          |                                |                          |    |          |                |   |    |          |                                    |   |    |          |                               |   |    |          |                                   |   |    |          |   |   |    |          |                       |   |    |          |                   |   |    |
| VL1065A1  | 1/4 MALE N.O. PRESSURE SWITCH             | 1  | PZ         |  |   |      |             |  |     |          |                 |                                     |    |          |   |                                    |    |          |                              |                                |   |          |                                |                          |    |          |                |   |    |          |                                    |   |    |          |                               |   |    |          |                                   |   |    |          |   |   |    |          |                       |   |    |          |                   |   |    |
| VL1067A0  | WASHING SYSTEM INLETS DISTRIBUTOR         | 1  | PZ         |  |   |      |             |  |     |          |                 |                                     |    |          |   |                                    |    |          |                              |                                |   |          |                                |                          |    |          |                |   |    |          |                                    |   |    |          |                               |   |    |          |                                   |   |    |          |   |   |    |          |                       |   |    |          |                   |   |    |
| VL1102A1  | DETERGENT LINE FILTER + BARBED VNR 6 MM   | 1  | PZ         |  |   |      |             |  |     |          |                 |                                     |    |          |   |                                    |    |          |                              |                                |   |          |                                |                          |    |          |                |   |    |          |                                    |   |    |          |                               |   |    |          |                                   |   |    |          |   |   |    |          |                       |   |    |          |                   |   |    |
| VL1128A0  | BARBED CHECK VALVE D6                     | 1  | PZ         |  |   |      |             |  |     |          |                 |                                     |    |          |   |                                    |    |          |                              |                                |   |          |                                |                          |    |          |                |   |    |          |                                    |   |    |          |                               |   |    |          |                                   |   |    |          |   |   |    |          |                       |   |    |          |                   |   |    |
| VM2172A0  | PUMP LOCKING CLIP                         | 1  | PZ         |  |   |      |             |  |     |          |                 |                                     |    |          |   |                                    |    |          |                              |                                |   |          |                                |                          |    |          |                |   |    |          |                                    |   |    |          |                               |   |    |          |                                   |   |    |          |   |   |    |          |                       |   |    |          |                   |   |    |
| KVL1103A  | EUR 2 ROTOR ARMS PLUS CLEANING SYSTEM KIT | <table border="1"> <thead> <tr> <th>Code</th> <th>Description</th> <th>Qty</th> <th>UOM</th> </tr> </thead> <tbody> <tr> <td>0H7820A0</td> <td>PLUS WASHING SY SUPPORT WITH STEAM VALVE</td> <td>1</td> <td>PZ</td> </tr> <tr> <td>EL1252A1</td> <td>1 WAY WATER VALVE + J.G. CONNECTION</td> <td>1</td> <td>PZ</td> </tr> <tr> <td>EL1424A0</td> <td>D8 CONNECTION WATER SOLENOID VALVE</td> <td>2</td> <td>PZ</td> </tr> <tr> <td>EL1436A0</td> <td>H2O SOLENOID JG D8 CHECK VALVE</td> <td>1</td> <td>PZ</td> </tr> <tr> <td>GN1526A0</td> <td>INT. D.=6.9 TH=1.8 O-RIN</td> <td>1</td> <td>PZ</td> </tr> </tbody> </table> | Code       | Description                              | Qty   | UOM  | 0H7820A0    | PLUS WASHING SY SUPPORT WITH STEAM VALVE | 1   | PZ       | EL1252A1        | 1 WAY WATER VALVE + J.G. CONNECTION | 1  | PZ       | EL1424A0                                | D8 CONNECTION WATER SOLENOID VALVE | 2  | PZ       | EL1436A0                     | H2O SOLENOID JG D8 CHECK VALVE | 1 | PZ       | GN1526A0                       | INT. D.=6.9 TH=1.8 O-RIN | 1  | PZ       |                |   |    |          |                                    |   |    |          |                               |   |    |          |                                   |   |    |          |   |   |    |          |                       |   |    |          |                   |   |    |
| Code      | Description                               | Qty  | UOM        |  |   |      |             |  |     |          |                 |                                     |    |          |   |                                    |    |          |                              |                                |   |          |                                |                          |    |          |                |   |    |          |                                    |   |    |          |                               |   |    |          |                                   |   |    |          |   |   |    |          |                       |   |    |          |                   |   |    |
| 0H7820A0  | PLUS WASHING SY SUPPORT WITH STEAM VALVE  | 1  | PZ         |  |   |      |             |  |     |          |                 |                                     |    |          |   |                                    |    |          |                              |                                |   |          |                                |                          |    |          |                |   |    |          |                                    |   |    |          |                               |   |    |          |                                   |   |    |          |   |   |    |          |                       |   |    |          |                   |   |    |
| EL1252A1  | 1 WAY WATER VALVE + J.G. CONNECTION       | 1  | PZ         |  |   |      |             |  |     |          |                 |                                     |    |          |   |                                    |    |          |                              |                                |   |          |                                |                          |    |          |                |   |    |          |                                    |   |    |          |                               |   |    |          |                                   |   |    |          |   |   |    |          |                       |   |    |          |                   |   |    |
| EL1424A0  | D8 CONNECTION WATER SOLENOID VALVE        | 2  | PZ         |  |   |      |             |  |     |          |                 |                                     |    |          |   |                                    |    |          |                              |                                |   |          |                                |                          |    |          |                |   |    |          |                                    |   |    |          |                               |   |    |          |                                   |   |    |          |   |   |    |          |                       |   |    |          |                   |   |    |
| EL1436A0  | H2O SOLENOID JG D8 CHECK VALVE            | 1  | PZ         |  |   |      |             |  |     |          |                 |                                     |    |          |   |                                    |    |          |                              |                                |   |          |                                |                          |    |          |                |   |    |          |                                    |   |    |          |                               |   |    |          |                                   |   |    |          |   |   |    |          |                       |   |    |          |                   |   |    |
| GN1526A0  | INT. D.=6.9 TH=1.8 O-RIN                  | 1  | PZ         |  |   |      |             |  |     |          |                 |                                     |    |          |   |                                    |    |          |                              |                                |   |          |                                |                          |    |          |                |   |    |          |                                    |   |    |          |                               |   |    |          |                                   |   |    |          |   |   |    |          |                       |   |    |          |                   |   |    |

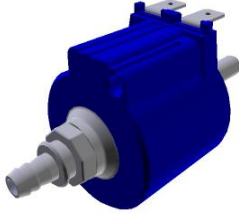

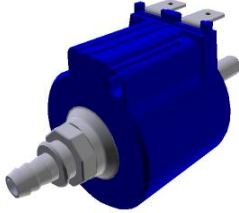

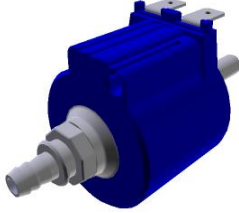
| COMPONENT |  |   | SPARE PART |   |  |      |             |     |     |          |                    |    |    |          |              |   |    |          |                 |   |    |          |   |   |    |          |                              |       |   |          |                                |   |    |          |                |   |    |          |                               |   |    |          |                                   |   |    |          |  |   |    |          |   |   |    |          |                       |   |    |          |                   |   |    |          |  |  |      |             |     |     |          |  |   |    |          |                                     |   |    |          |                                    |   |    |
|-----------|--|---|------------|---|--|------|-------------|-----|-----|----------|--------------------|----|----|----------|--------------|---|----|----------|-----------------|---|----|----------|---|---|----|----------|------------------------------|-------|---|----------|--------------------------------|---|----|----------|----------------|---|----|----------|-------------------------------|---|----|----------|-----------------------------------|---|----|----------|--|---|----|----------|---|---|----|----------|-----------------------|---|----|----------|-------------------|---|----|----------|--|--|------|-------------|-----|-----|----------|--|---|----|----------|-------------------------------------|---|----|----------|------------------------------------|---|----|
| Code      | Description                              | Image   | Code       | Description                               | Components list  |      |             |     |     |          |                    |    |    |          |              |   |    |          |                 |   |    |          |   |   |    |          |                              |       |   |          |                                |   |    |          |                |   |    |          |                               |   |    |          |                                   |   |    |          |  |   |    |          |   |   |    |          |                       |   |    |          |                   |   |    |          |  |  |      |             |     |     |          |  |   |    |          |                                     |   |    |          |                                    |   |    |
| VL1019A   | VIBRATION PUMP                           |  | KVL1103A   | EUR 2 ROTOR ARMS PLUS CLEANING SYSTEM KIT | <table border="1"> <thead> <tr> <th>Code</th> <th>Description</th> <th>Qty</th> <th>UOM</th> </tr> </thead> <tbody> <tr> <td>RC1019A0</td> <td>D=10 ELASTIC CLAMP</td> <td>12</td> <td>PZ</td> </tr> <tr> <td>RC1130A0</td> <td>130X2,6 CLAM</td> <td>1</td> <td>PZ</td> </tr> <tr> <td>RC1242A0</td> <td>D=10 CLOSED CAP</td> <td>2</td> <td>PZ</td> </tr> <tr> <td>RC1356A0</td> <td>STRAIGHT THREADED FEMALE END 8X1/4" BSP</td> <td>1</td> <td>PZ</td> </tr> <tr> <td>TB2820A0</td> <td>PIPE EPDM FOR WASHING SYSTEM</td> <td>1.410</td> <td>M</td> </tr> <tr> <td>VI1220A1</td> <td>4,2X12 TCB SELF-TAPPIN G SCREW</td> <td>3</td> <td>PZ</td> </tr> <tr> <td>VL1019A0</td> <td>VIBRATION PUMP</td> <td>1</td> <td>PZ</td> </tr> <tr> <td>VL1065A1</td> <td>1/4 MALE N.O. PRESSURE SWITCH</td> <td>1</td> <td>PZ</td> </tr> <tr> <td>VL1067A0</td> <td>WASHING SYSTEM INLETS DISTRIBUTOR</td> <td>1</td> <td>PZ</td> </tr> <tr> <td>VL1092A0</td> <td>WASHING SYSTEM OUTLET DOUBLE DISTRIBUTOR</td> <td>1</td> <td>PZ</td> </tr> <tr> <td>VL1102A1</td> <td>DETERGENT LINE FILTER + BARBED VNR 6 MM</td> <td>1</td> <td>PZ</td> </tr> <tr> <td>VL1128A0</td> <td>BARBED CHECK VALVE D6</td> <td>1</td> <td>PZ</td> </tr> <tr> <td>VM2172A0</td> <td>PUMP LOCKING CLIP</td> <td>1</td> <td>PZ</td> </tr> </tbody> </table> | Code | Description | Qty | UOM | RC1019A0 | D=10 ELASTIC CLAMP | 12 | PZ | RC1130A0 | 130X2,6 CLAM | 1 | PZ | RC1242A0 | D=10 CLOSED CAP | 2 | PZ | RC1356A0 | STRAIGHT THREADED FEMALE END 8X1/4" BSP | 1 | PZ | TB2820A0 | PIPE EPDM FOR WASHING SYSTEM | 1.410 | M | VI1220A1 | 4,2X12 TCB SELF-TAPPIN G SCREW | 3 | PZ | VL1019A0 | VIBRATION PUMP | 1 | PZ | VL1065A1 | 1/4 MALE N.O. PRESSURE SWITCH | 1 | PZ | VL1067A0 | WASHING SYSTEM INLETS DISTRIBUTOR | 1 | PZ | VL1092A0 | WASHING SYSTEM OUTLET DOUBLE DISTRIBUTOR | 1 | PZ | VL1102A1 | DETERGENT LINE FILTER + BARBED VNR 6 MM | 1 | PZ | VL1128A0 | BARBED CHECK VALVE D6 | 1 | PZ | VM2172A0 | PUMP LOCKING CLIP | 1 | PZ | KVL1101A | EUR 1 ROTOR ARM PLUS CLEANING SYSTEM KIT | <table border="1"> <thead> <tr> <th>Code</th> <th>Description</th> <th>Qty</th> <th>UOM</th> </tr> </thead> <tbody> <tr> <td>0H7820A0</td> <td>PLUS WASHING SY SUPPORT WITH STEAM VALVE</td> <td>1</td> <td>PZ</td> </tr> <tr> <td>EL1252A1</td> <td>1 WAY WATER VALVE + J.G. CONNECTION</td> <td>1</td> <td>PZ</td> </tr> <tr> <td>EL1424A0</td> <td>D8 CONNECTION WATER SOLENOID VALVE</td> <td>1</td> <td>PZ</td> </tr> </tbody> </table> | Code | Description | Qty | UOM | 0H7820A0 | PLUS WASHING SY SUPPORT WITH STEAM VALVE | 1 | PZ | EL1252A1 | 1 WAY WATER VALVE + J.G. CONNECTION | 1 | PZ | EL1424A0 | D8 CONNECTION WATER SOLENOID VALVE | 1 | PZ |
|           |  |   | Code       | Description                               | Qty  | UOM  |             |     |     |          |                    |    |    |          |              |   |    |          |                 |   |    |          |   |   |    |          |                              |       |   |          |                                |   |    |          |                |   |    |          |                               |   |    |          |                                   |   |    |          |  |   |    |          |   |   |    |          |                       |   |    |          |                   |   |    |          |  |  |      |             |     |     |          |  |   |    |          |                                     |   |    |          |                                    |   |    |
| RC1019A0  | D=10 ELASTIC CLAMP                       | 12  | PZ         |   |  |      |             |     |     |          |                    |    |    |          |              |   |    |          |                 |   |    |          |   |   |    |          |                              |       |   |          |                                |   |    |          |                |   |    |          |                               |   |    |          |                                   |   |    |          |  |   |    |          |   |   |    |          |                       |   |    |          |                   |   |    |          |  |  |      |             |     |     |          |  |   |    |          |                                     |   |    |          |                                    |   |    |
| RC1130A0  | 130X2,6 CLAM                             | 1   | PZ         |   |  |      |             |     |     |          |                    |    |    |          |              |   |    |          |                 |   |    |          |   |   |    |          |                              |       |   |          |                                |   |    |          |                |   |    |          |                               |   |    |          |                                   |   |    |          |  |   |    |          |   |   |    |          |                       |   |    |          |                   |   |    |          |  |  |      |             |     |     |          |  |   |    |          |                                     |   |    |          |                                    |   |    |
| RC1242A0  | D=10 CLOSED CAP                          | 2   | PZ         |   |  |      |             |     |     |          |                    |    |    |          |              |   |    |          |                 |   |    |          |   |   |    |          |                              |       |   |          |                                |   |    |          |                |   |    |          |                               |   |    |          |                                   |   |    |          |  |   |    |          |   |   |    |          |                       |   |    |          |                   |   |    |          |  |  |      |             |     |     |          |  |   |    |          |                                     |   |    |          |                                    |   |    |
| RC1356A0  | STRAIGHT THREADED FEMALE END 8X1/4" BSP  | 1   | PZ         |   |  |      |             |     |     |          |                    |    |    |          |              |   |    |          |                 |   |    |          |   |   |    |          |                              |       |   |          |                                |   |    |          |                |   |    |          |                               |   |    |          |                                   |   |    |          |  |   |    |          |   |   |    |          |                       |   |    |          |                   |   |    |          |  |  |      |             |     |     |          |  |   |    |          |                                     |   |    |          |                                    |   |    |
| TB2820A0  | PIPE EPDM FOR WASHING SYSTEM             | 1.410   | M          |   |  |      |             |     |     |          |                    |    |    |          |              |   |    |          |                 |   |    |          |   |   |    |          |                              |       |   |          |                                |   |    |          |                |   |    |          |                               |   |    |          |                                   |   |    |          |  |   |    |          |   |   |    |          |                       |   |    |          |                   |   |    |          |  |  |      |             |     |     |          |  |   |    |          |                                     |   |    |          |                                    |   |    |
| VI1220A1  | 4,2X12 TCB SELF-TAPPIN G SCREW           | 3   | PZ         |   |  |      |             |     |     |          |                    |    |    |          |              |   |    |          |                 |   |    |          |   |   |    |          |                              |       |   |          |                                |   |    |          |                |   |    |          |                               |   |    |          |                                   |   |    |          |  |   |    |          |   |   |    |          |                       |   |    |          |                   |   |    |          |  |  |      |             |     |     |          |  |   |    |          |                                     |   |    |          |                                    |   |    |
| VL1019A0  | VIBRATION PUMP                           | 1   | PZ         |   |  |      |             |     |     |          |                    |    |    |          |              |   |    |          |                 |   |    |          |   |   |    |          |                              |       |   |          |                                |   |    |          |                |   |    |          |                               |   |    |          |                                   |   |    |          |  |   |    |          |   |   |    |          |                       |   |    |          |                   |   |    |          |  |  |      |             |     |     |          |  |   |    |          |                                     |   |    |          |                                    |   |    |
| VL1065A1  | 1/4 MALE N.O. PRESSURE SWITCH            | 1   | PZ         |   |  |      |             |     |     |          |                    |    |    |          |              |   |    |          |                 |   |    |          |   |   |    |          |                              |       |   |          |                                |   |    |          |                |   |    |          |                               |   |    |          |                                   |   |    |          |  |   |    |          |   |   |    |          |                       |   |    |          |                   |   |    |          |  |  |      |             |     |     |          |  |   |    |          |                                     |   |    |          |                                    |   |    |
| VL1067A0  | WASHING SYSTEM INLETS DISTRIBUTOR        | 1   | PZ         |   |  |      |             |     |     |          |                    |    |    |          |              |   |    |          |                 |   |    |          |   |   |    |          |                              |       |   |          |                                |   |    |          |                |   |    |          |                               |   |    |          |                                   |   |    |          |  |   |    |          |   |   |    |          |                       |   |    |          |                   |   |    |          |  |  |      |             |     |     |          |  |   |    |          |                                     |   |    |          |                                    |   |    |
| VL1092A0  | WASHING SYSTEM OUTLET DOUBLE DISTRIBUTOR | 1   | PZ         |   |  |      |             |     |     |          |                    |    |    |          |              |   |    |          |                 |   |    |          |   |   |    |          |                              |       |   |          |                                |   |    |          |                |   |    |          |                               |   |    |          |                                   |   |    |          |  |   |    |          |   |   |    |          |                       |   |    |          |                   |   |    |          |  |  |      |             |     |     |          |  |   |    |          |                                     |   |    |          |                                    |   |    |
| VL1102A1  | DETERGENT LINE FILTER + BARBED VNR 6 MM  | 1   | PZ         |   |  |      |             |     |     |          |                    |    |    |          |              |   |    |          |                 |   |    |          |   |   |    |          |                              |       |   |          |                                |   |    |          |                |   |    |          |                               |   |    |          |                                   |   |    |          |  |   |    |          |   |   |    |          |                       |   |    |          |                   |   |    |          |  |  |      |             |     |     |          |  |   |    |          |                                     |   |    |          |                                    |   |    |
| VL1128A0  | BARBED CHECK VALVE D6                    | 1   | PZ         |   |  |      |             |     |     |          |                    |    |    |          |              |   |    |          |                 |   |    |          |   |   |    |          |                              |       |   |          |                                |   |    |          |                |   |    |          |                               |   |    |          |                                   |   |    |          |  |   |    |          |   |   |    |          |                       |   |    |          |                   |   |    |          |  |  |      |             |     |     |          |  |   |    |          |                                     |   |    |          |                                    |   |    |
| VM2172A0  | PUMP LOCKING CLIP                        | 1   | PZ         |   |  |      |             |     |     |          |                    |    |    |          |              |   |    |          |                 |   |    |          |   |   |    |          |                              |       |   |          |                                |   |    |          |                |   |    |          |                               |   |    |          |                                   |   |    |          |  |   |    |          |   |   |    |          |                       |   |    |          |                   |   |    |          |  |  |      |             |     |     |          |  |   |    |          |                                     |   |    |          |                                    |   |    |
| Code      | Description                              | Qty   | UOM        |   |  |      |             |     |     |          |                    |    |    |          |              |   |    |          |                 |   |    |          |   |   |    |          |                              |       |   |          |                                |   |    |          |                |   |    |          |                               |   |    |          |                                   |   |    |          |  |   |    |          |   |   |    |          |                       |   |    |          |                   |   |    |          |  |  |      |             |     |     |          |  |   |    |          |                                     |   |    |          |                                    |   |    |
| 0H7820A0  | PLUS WASHING SY SUPPORT WITH STEAM VALVE | 1   | PZ         |   |  |      |             |     |     |          |                    |    |    |          |              |   |    |          |                 |   |    |          |   |   |    |          |                              |       |   |          |                                |   |    |          |                |   |    |          |                               |   |    |          |                                   |   |    |          |  |   |    |          |   |   |    |          |                       |   |    |          |                   |   |    |          |  |  |      |             |     |     |          |  |   |    |          |                                     |   |    |          |                                    |   |    |
| EL1252A1  | 1 WAY WATER VALVE + J.G. CONNECTION      | 1   | PZ         |   |  |      |             |     |     |          |                    |    |    |          |              |   |    |          |                 |   |    |          |   |   |    |          |                              |       |   |          |                                |   |    |          |                |   |    |          |                               |   |    |          |                                   |   |    |          |  |   |    |          |   |   |    |          |                       |   |    |          |                   |   |    |          |  |  |      |             |     |     |          |  |   |    |          |                                     |   |    |          |                                    |   |    |
| EL1424A0  | D8 CONNECTION WATER SOLENOID VALVE       | 1   | PZ         |   |  |      |             |     |     |          |                    |    |    |          |              |   |    |          |                 |   |    |          |   |   |    |          |                              |       |   |          |                                |   |    |          |                |   |    |          |                               |   |    |          |                                   |   |    |          |  |   |    |          |   |   |    |          |                       |   |    |          |                   |   |    |          |  |  |      |             |     |     |          |  |   |    |          |                                     |   |    |          |                                    |   |    |

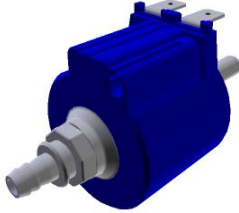
| COMPONENT |   |   | SPARE PART |  |  |      |             |     |     |          |                                |   |    |          |                          |   |    |          |                    |    |    |          |              |   |    |          |                 |   |    |          |   |   |    |          |                              |       |   |          |                                |   |    |          |                |   |    |          |                                    |   |    |          |                               |   |    |          |                                   |   |    |          |   |   |    |          |                       |   |    |          |                   |   |    |          |                              |  |      |             |     |     |          |                                   |   |    |          |                                |   |    |
|-----------|---|---|------------|--|--|------|-------------|-----|-----|----------|--------------------------------|---|----|----------|--------------------------|---|----|----------|--------------------|----|----|----------|--------------|---|----|----------|-----------------|---|----|----------|---|---|----|----------|------------------------------|-------|---|----------|--------------------------------|---|----|----------|----------------|---|----|----------|------------------------------------|---|----|----------|-------------------------------|---|----|----------|-----------------------------------|---|----|----------|---|---|----|----------|-----------------------|---|----|----------|-------------------|---|----|----------|------------------------------|--|------|-------------|-----|-----|----------|-----------------------------------|---|----|----------|--------------------------------|---|----|
| Code      | Description                             | Image   | Code       | Description                              | Components list  |      |             |     |     |          |                                |   |    |          |                          |   |    |          |                    |    |    |          |              |   |    |          |                 |   |    |          |   |   |    |          |                              |       |   |          |                                |   |    |          |                |   |    |          |                                    |   |    |          |                               |   |    |          |                                   |   |    |          |   |   |    |          |                       |   |    |          |                   |   |    |          |                              |  |      |             |     |     |          |                                   |   |    |          |                                |   |    |
| VL1019A   | VIBRATION PUMP                          |  | KVL1101A   | EUR 1 ROTOR ARM PLUS CLEANING SYSTEM KIT | <table border="1"> <thead> <tr> <th>Code</th> <th>Description</th> <th>Qty</th> <th>UOM</th> </tr> </thead> <tbody> <tr> <td>EL1436A0</td> <td>H2O SOLENOID JG D8 CHECK VALVE</td> <td>1</td> <td>PZ</td> </tr> <tr> <td>GN1526A0</td> <td>INT. D.=6.9 TH=1.8 O-RIN</td> <td>1</td> <td>PZ</td> </tr> <tr> <td>RC1019A0</td> <td>D=10 ELASTIC CLAMP</td> <td>12</td> <td>PZ</td> </tr> <tr> <td>RC1130A0</td> <td>130X2,6 CLAM</td> <td>1</td> <td>PZ</td> </tr> <tr> <td>RC1242A0</td> <td>D=10 CLOSED CAP</td> <td>2</td> <td>PZ</td> </tr> <tr> <td>RC1356A0</td> <td>STRAIGHT THREADED FEMALE END 8X1/4" BSP</td> <td>1</td> <td>PZ</td> </tr> <tr> <td>TB2820A0</td> <td>PIPE EPDM FOR WASHING SYSTEM</td> <td>1.410</td> <td>M</td> </tr> <tr> <td>VI1220A1</td> <td>4,2X12 TCB SELF-TAPPIN G SCREW</td> <td>3</td> <td>PZ</td> </tr> <tr> <td>VL1019A0</td> <td>VIBRATION PUMP</td> <td>1</td> <td>PZ</td> </tr> <tr> <td>VL1064A0</td> <td>WASHING SYSTEM OUTLETS DISTRIBUTOR</td> <td>1</td> <td>PZ</td> </tr> <tr> <td>VL1065A1</td> <td>1/4 MALE N.O. PRESSURE SWITCH</td> <td>1</td> <td>PZ</td> </tr> <tr> <td>VL1067A0</td> <td>WASHING SYSTEM INLETS DISTRIBUTOR</td> <td>1</td> <td>PZ</td> </tr> <tr> <td>VL1102A1</td> <td>DETERGENT LINE FILTER + BARBED VNR 6 MM</td> <td>1</td> <td>PZ</td> </tr> <tr> <td>VL1128A0</td> <td>BARBED CHECK VALVE D6</td> <td>1</td> <td>PZ</td> </tr> <tr> <td>VM2172A0</td> <td>PUMP LOCKING CLIP</td> <td>1</td> <td>PZ</td> </tr> </tbody> </table> | Code | Description | Qty | UOM | EL1436A0 | H2O SOLENOID JG D8 CHECK VALVE | 1 | PZ | GN1526A0 | INT. D.=6.9 TH=1.8 O-RIN | 1 | PZ | RC1019A0 | D=10 ELASTIC CLAMP | 12 | PZ | RC1130A0 | 130X2,6 CLAM | 1 | PZ | RC1242A0 | D=10 CLOSED CAP | 2 | PZ | RC1356A0 | STRAIGHT THREADED FEMALE END 8X1/4" BSP | 1 | PZ | TB2820A0 | PIPE EPDM FOR WASHING SYSTEM | 1.410 | M | VI1220A1 | 4,2X12 TCB SELF-TAPPIN G SCREW | 3 | PZ | VL1019A0 | VIBRATION PUMP | 1 | PZ | VL1064A0 | WASHING SYSTEM OUTLETS DISTRIBUTOR | 1 | PZ | VL1065A1 | 1/4 MALE N.O. PRESSURE SWITCH | 1 | PZ | VL1067A0 | WASHING SYSTEM INLETS DISTRIBUTOR | 1 | PZ | VL1102A1 | DETERGENT LINE FILTER + BARBED VNR 6 MM | 1 | PZ | VL1128A0 | BARBED CHECK VALVE D6 | 1 | PZ | VM2172A0 | PUMP LOCKING CLIP | 1 | PZ | KVL1094A | 0311 EUR CLEANING SYSTEM KIT | <table border="1"> <thead> <tr> <th>Code</th> <th>Description</th> <th>Qty</th> <th>UOM</th> </tr> </thead> <tbody> <tr> <td>0H7494B0</td> <td>ONE-03 WASHING SYST HOLDING PLATE</td> <td>1</td> <td>PZ</td> </tr> <tr> <td>EL1436A0</td> <td>H2O SOLENOID JG D8 CHECK VALVE</td> <td>1</td> <td>PZ</td> </tr> </tbody> </table> | Code | Description | Qty | UOM | 0H7494B0 | ONE-03 WASHING SYST HOLDING PLATE | 1 | PZ | EL1436A0 | H2O SOLENOID JG D8 CHECK VALVE | 1 | PZ |
|           |   |   | Code       | Description                              | Qty  | UOM  |             |     |     |          |                                |   |    |          |                          |   |    |          |                    |    |    |          |              |   |    |          |                 |   |    |          |   |   |    |          |                              |       |   |          |                                |   |    |          |                |   |    |          |                                    |   |    |          |                               |   |    |          |                                   |   |    |          |   |   |    |          |                       |   |    |          |                   |   |    |          |                              |  |      |             |     |     |          |                                   |   |    |          |                                |   |    |
| EL1436A0  | H2O SOLENOID JG D8 CHECK VALVE          | 1   | PZ         |  |  |      |             |     |     |          |                                |   |    |          |                          |   |    |          |                    |    |    |          |              |   |    |          |                 |   |    |          |   |   |    |          |                              |       |   |          |                                |   |    |          |                |   |    |          |                                    |   |    |          |                               |   |    |          |                                   |   |    |          |   |   |    |          |                       |   |    |          |                   |   |    |          |                              |  |      |             |     |     |          |                                   |   |    |          |                                |   |    |
| GN1526A0  | INT. D.=6.9 TH=1.8 O-RIN                | 1   | PZ         |  |  |      |             |     |     |          |                                |   |    |          |                          |   |    |          |                    |    |    |          |              |   |    |          |                 |   |    |          |   |   |    |          |                              |       |   |          |                                |   |    |          |                |   |    |          |                                    |   |    |          |                               |   |    |          |                                   |   |    |          |   |   |    |          |                       |   |    |          |                   |   |    |          |                              |  |      |             |     |     |          |                                   |   |    |          |                                |   |    |
| RC1019A0  | D=10 ELASTIC CLAMP                      | 12  | PZ         |  |  |      |             |     |     |          |                                |   |    |          |                          |   |    |          |                    |    |    |          |              |   |    |          |                 |   |    |          |   |   |    |          |                              |       |   |          |                                |   |    |          |                |   |    |          |                                    |   |    |          |                               |   |    |          |                                   |   |    |          |   |   |    |          |                       |   |    |          |                   |   |    |          |                              |  |      |             |     |     |          |                                   |   |    |          |                                |   |    |
| RC1130A0  | 130X2,6 CLAM                            | 1   | PZ         |  |  |      |             |     |     |          |                                |   |    |          |                          |   |    |          |                    |    |    |          |              |   |    |          |                 |   |    |          |   |   |    |          |                              |       |   |          |                                |   |    |          |                |   |    |          |                                    |   |    |          |                               |   |    |          |                                   |   |    |          |   |   |    |          |                       |   |    |          |                   |   |    |          |                              |  |      |             |     |     |          |                                   |   |    |          |                                |   |    |
| RC1242A0  | D=10 CLOSED CAP                         | 2   | PZ         |  |  |      |             |     |     |          |                                |   |    |          |                          |   |    |          |                    |    |    |          |              |   |    |          |                 |   |    |          |   |   |    |          |                              |       |   |          |                                |   |    |          |                |   |    |          |                                    |   |    |          |                               |   |    |          |                                   |   |    |          |   |   |    |          |                       |   |    |          |                   |   |    |          |                              |  |      |             |     |     |          |                                   |   |    |          |                                |   |    |
| RC1356A0  | STRAIGHT THREADED FEMALE END 8X1/4" BSP | 1   | PZ         |  |  |      |             |     |     |          |                                |   |    |          |                          |   |    |          |                    |    |    |          |              |   |    |          |                 |   |    |          |   |   |    |          |                              |       |   |          |                                |   |    |          |                |   |    |          |                                    |   |    |          |                               |   |    |          |                                   |   |    |          |   |   |    |          |                       |   |    |          |                   |   |    |          |                              |  |      |             |     |     |          |                                   |   |    |          |                                |   |    |
| TB2820A0  | PIPE EPDM FOR WASHING SYSTEM            | 1.410   | M          |  |  |      |             |     |     |          |                                |   |    |          |                          |   |    |          |                    |    |    |          |              |   |    |          |                 |   |    |          |   |   |    |          |                              |       |   |          |                                |   |    |          |                |   |    |          |                                    |   |    |          |                               |   |    |          |                                   |   |    |          |   |   |    |          |                       |   |    |          |                   |   |    |          |                              |  |      |             |     |     |          |                                   |   |    |          |                                |   |    |
| VI1220A1  | 4,2X12 TCB SELF-TAPPIN G SCREW          | 3   | PZ         |  |  |      |             |     |     |          |                                |   |    |          |                          |   |    |          |                    |    |    |          |              |   |    |          |                 |   |    |          |   |   |    |          |                              |       |   |          |                                |   |    |          |                |   |    |          |                                    |   |    |          |                               |   |    |          |                                   |   |    |          |   |   |    |          |                       |   |    |          |                   |   |    |          |                              |  |      |             |     |     |          |                                   |   |    |          |                                |   |    |
| VL1019A0  | VIBRATION PUMP                          | 1   | PZ         |  |  |      |             |     |     |          |                                |   |    |          |                          |   |    |          |                    |    |    |          |              |   |    |          |                 |   |    |          |   |   |    |          |                              |       |   |          |                                |   |    |          |                |   |    |          |                                    |   |    |          |                               |   |    |          |                                   |   |    |          |   |   |    |          |                       |   |    |          |                   |   |    |          |                              |  |      |             |     |     |          |                                   |   |    |          |                                |   |    |
| VL1064A0  | WASHING SYSTEM OUTLETS DISTRIBUTOR      | 1   | PZ         |  |  |      |             |     |     |          |                                |   |    |          |                          |   |    |          |                    |    |    |          |              |   |    |          |                 |   |    |          |   |   |    |          |                              |       |   |          |                                |   |    |          |                |   |    |          |                                    |   |    |          |                               |   |    |          |                                   |   |    |          |   |   |    |          |                       |   |    |          |                   |   |    |          |                              |  |      |             |     |     |          |                                   |   |    |          |                                |   |    |
| VL1065A1  | 1/4 MALE N.O. PRESSURE SWITCH           | 1   | PZ         |  |  |      |             |     |     |          |                                |   |    |          |                          |   |    |          |                    |    |    |          |              |   |    |          |                 |   |    |          |   |   |    |          |                              |       |   |          |                                |   |    |          |                |   |    |          |                                    |   |    |          |                               |   |    |          |                                   |   |    |          |   |   |    |          |                       |   |    |          |                   |   |    |          |                              |  |      |             |     |     |          |                                   |   |    |          |                                |   |    |
| VL1067A0  | WASHING SYSTEM INLETS DISTRIBUTOR       | 1   | PZ         |  |  |      |             |     |     |          |                                |   |    |          |                          |   |    |          |                    |    |    |          |              |   |    |          |                 |   |    |          |   |   |    |          |                              |       |   |          |                                |   |    |          |                |   |    |          |                                    |   |    |          |                               |   |    |          |                                   |   |    |          |   |   |    |          |                       |   |    |          |                   |   |    |          |                              |  |      |             |     |     |          |                                   |   |    |          |                                |   |    |
| VL1102A1  | DETERGENT LINE FILTER + BARBED VNR 6 MM | 1   | PZ         |  |  |      |             |     |     |          |                                |   |    |          |                          |   |    |          |                    |    |    |          |              |   |    |          |                 |   |    |          |   |   |    |          |                              |       |   |          |                                |   |    |          |                |   |    |          |                                    |   |    |          |                               |   |    |          |                                   |   |    |          |   |   |    |          |                       |   |    |          |                   |   |    |          |                              |  |      |             |     |     |          |                                   |   |    |          |                                |   |    |
| VL1128A0  | BARBED CHECK VALVE D6                   | 1   | PZ         |  |  |      |             |     |     |          |                                |   |    |          |                          |   |    |          |                    |    |    |          |              |   |    |          |                 |   |    |          |   |   |    |          |                              |       |   |          |                                |   |    |          |                |   |    |          |                                    |   |    |          |                               |   |    |          |                                   |   |    |          |   |   |    |          |                       |   |    |          |                   |   |    |          |                              |  |      |             |     |     |          |                                   |   |    |          |                                |   |    |
| VM2172A0  | PUMP LOCKING CLIP                       | 1   | PZ         |  |  |      |             |     |     |          |                                |   |    |          |                          |   |    |          |                    |    |    |          |              |   |    |          |                 |   |    |          |   |   |    |          |                              |       |   |          |                                |   |    |          |                |   |    |          |                                    |   |    |          |                               |   |    |          |                                   |   |    |          |   |   |    |          |                       |   |    |          |                   |   |    |          |                              |  |      |             |     |     |          |                                   |   |    |          |                                |   |    |
| Code      | Description                             | Qty   | UOM        |  |  |      |             |     |     |          |                                |   |    |          |                          |   |    |          |                    |    |    |          |              |   |    |          |                 |   |    |          |   |   |    |          |                              |       |   |          |                                |   |    |          |                |   |    |          |                                    |   |    |          |                               |   |    |          |                                   |   |    |          |   |   |    |          |                       |   |    |          |                   |   |    |          |                              |  |      |             |     |     |          |                                   |   |    |          |                                |   |    |
| 0H7494B0  | ONE-03 WASHING SYST HOLDING PLATE       | 1   | PZ         |  |  |      |             |     |     |          |                                |   |    |          |                          |   |    |          |                    |    |    |          |              |   |    |          |                 |   |    |          |   |   |    |          |                              |       |   |          |                                |   |    |          |                |   |    |          |                                    |   |    |          |                               |   |    |          |                                   |   |    |          |   |   |    |          |                       |   |    |          |                   |   |    |          |                              |  |      |             |     |     |          |                                   |   |    |          |                                |   |    |
| EL1436A0  | H2O SOLENOID JG D8 CHECK VALVE          | 1   | PZ         |  |  |      |             |     |     |          |                                |   |    |          |                          |   |    |          |                    |    |    |          |              |   |    |          |                 |   |    |          |   |   |    |          |                              |       |   |          |                                |   |    |          |                |   |    |          |                                    |   |    |          |                               |   |    |          |                                   |   |    |          |   |   |    |          |                       |   |    |          |                   |   |    |          |                              |  |      |             |     |     |          |                                   |   |    |          |                                |   |    |

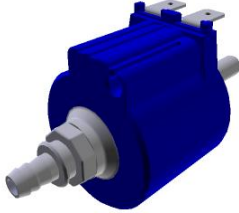
| COMPONENT |  |  | SPARE PART |                              |  |      |             |                          |     |          |                          |                    |    |          |                 |              |    |          |                              |                 |   |          |                                |                              |       |          |                |                |    |          |                                 |                                   |    |          |                                   |  |    |          |   |                       |    |          |                       |                   |    |          |                   |   |    |
|-----------|--|--|------------|------------------------------|--|------|-------------|--------------------------|-----|----------|--------------------------|--------------------|----|----------|-----------------|--------------|----|----------|------------------------------|-----------------|---|----------|--------------------------------|------------------------------|-------|----------|----------------|----------------|----|----------|---------------------------------|-----------------------------------|----|----------|-----------------------------------|--|----|----------|---|-----------------------|----|----------|-----------------------|-------------------|----|----------|-------------------|---|----|
| Code      | Description                              | Image  | Code       | Description                  | Components list  |      |             |                          |     |          |                          |                    |    |          |                 |              |    |          |                              |                 |   |          |                                |                              |       |          |                |                |    |          |                                 |                                   |    |          |                                   |  |    |          |   |                       |    |          |                       |                   |    |          |                   |   |    |
| VL1019A   | VIBRATION PUMP                           |   | KVL1094A   | 0311 EUR CLEANING SYSTEM KIT | <table border="1"> <thead> <tr> <th>Code</th> <th>Description</th> <th>Qty</th> <th>UOM</th> </tr> </thead> <tbody> <tr> <td>GN1526A0</td> <td>INT. D.=6.9 TH=1.8 O-RIN</td> <td>1</td> <td>PZ</td> </tr> <tr> <td>RC1242A0</td> <td>D=10 CLOSED CAP</td> <td>2</td> <td>PZ</td> </tr> <tr> <td>TB2820A0</td> <td>PIPE EPDM FOR WASHING SYSTEM</td> <td>1.420</td> <td>M</td> </tr> <tr> <td>VI1220A1</td> <td>4,2X12 TCB SELF-TAPPIN G SCREW</td> <td>1</td> <td>PZ</td> </tr> <tr> <td>VL1019A0</td> <td>VIBRATION PUMP</td> <td>1</td> <td>PZ</td> </tr> <tr> <td>VL1053B0</td> <td>ONE WASHING SYS EXT DISTRIBUTOR</td> <td>1</td> <td>PZ</td> </tr> <tr> <td>VL1054B0</td> <td>ONE WASHING SYS INLET DISTRIBUTOR</td> <td>1</td> <td>PZ</td> </tr> <tr> <td>VL1102A1</td> <td>DETERGENT LINE FILTER + BARBED VNR 6 MM</td> <td>1</td> <td>PZ</td> </tr> <tr> <td>VL1128A0</td> <td>BARBED CHECK VALVE D6</td> <td>1</td> <td>PZ</td> </tr> <tr> <td>VM2172A0</td> <td>PUMP LOCKING CLIP</td> <td>1</td> <td>PZ</td> </tr> </tbody> </table> | Code | Description | Qty                      | UOM | GN1526A0 | INT. D.=6.9 TH=1.8 O-RIN | 1                  | PZ | RC1242A0 | D=10 CLOSED CAP | 2            | PZ | TB2820A0 | PIPE EPDM FOR WASHING SYSTEM | 1.420           | M | VI1220A1 | 4,2X12 TCB SELF-TAPPIN G SCREW | 1                            | PZ    | VL1019A0 | VIBRATION PUMP | 1              | PZ | VL1053B0 | ONE WASHING SYS EXT DISTRIBUTOR | 1                                 | PZ | VL1054B0 | ONE WASHING SYS INLET DISTRIBUTOR | 1  | PZ | VL1102A1 | DETERGENT LINE FILTER + BARBED VNR 6 MM | 1                     | PZ | VL1128A0 | BARBED CHECK VALVE D6 | 1                 | PZ | VM2172A0 | PUMP LOCKING CLIP | 1 | PZ |
|           |  |  | Code       | Description                  | Qty  | UOM  |             |                          |     |          |                          |                    |    |          |                 |              |    |          |                              |                 |   |          |                                |                              |       |          |                |                |    |          |                                 |                                   |    |          |                                   |  |    |          |   |                       |    |          |                       |                   |    |          |                   |   |    |
| GN1526A0  | INT. D.=6.9 TH=1.8 O-RIN                 | 1  | PZ         |                              |  |      |             |                          |     |          |                          |                    |    |          |                 |              |    |          |                              |                 |   |          |                                |                              |       |          |                |                |    |          |                                 |                                   |    |          |                                   |  |    |          |   |                       |    |          |                       |                   |    |          |                   |   |    |
| RC1242A0  | D=10 CLOSED CAP                          | 2  | PZ         |                              |  |      |             |                          |     |          |                          |                    |    |          |                 |              |    |          |                              |                 |   |          |                                |                              |       |          |                |                |    |          |                                 |                                   |    |          |                                   |  |    |          |   |                       |    |          |                       |                   |    |          |                   |   |    |
| TB2820A0  | PIPE EPDM FOR WASHING SYSTEM             | 1.420  | M          |                              |  |      |             |                          |     |          |                          |                    |    |          |                 |              |    |          |                              |                 |   |          |                                |                              |       |          |                |                |    |          |                                 |                                   |    |          |                                   |  |    |          |   |                       |    |          |                       |                   |    |          |                   |   |    |
| VI1220A1  | 4,2X12 TCB SELF-TAPPIN G SCREW           | 1  | PZ         |                              |  |      |             |                          |     |          |                          |                    |    |          |                 |              |    |          |                              |                 |   |          |                                |                              |       |          |                |                |    |          |                                 |                                   |    |          |                                   |  |    |          |   |                       |    |          |                       |                   |    |          |                   |   |    |
| VL1019A0  | VIBRATION PUMP                           | 1  | PZ         |                              |  |      |             |                          |     |          |                          |                    |    |          |                 |              |    |          |                              |                 |   |          |                                |                              |       |          |                |                |    |          |                                 |                                   |    |          |                                   |  |    |          |   |                       |    |          |                       |                   |    |          |                   |   |    |
| VL1053B0  | ONE WASHING SYS EXT DISTRIBUTOR          | 1  | PZ         |                              |  |      |             |                          |     |          |                          |                    |    |          |                 |              |    |          |                              |                 |   |          |                                |                              |       |          |                |                |    |          |                                 |                                   |    |          |                                   |  |    |          |   |                       |    |          |                       |                   |    |          |                   |   |    |
| VL1054B0  | ONE WASHING SYS INLET DISTRIBUTOR        | 1  | PZ         |                              |  |      |             |                          |     |          |                          |                    |    |          |                 |              |    |          |                              |                 |   |          |                                |                              |       |          |                |                |    |          |                                 |                                   |    |          |                                   |  |    |          |   |                       |    |          |                       |                   |    |          |                   |   |    |
| VL1102A1  | DETERGENT LINE FILTER + BARBED VNR 6 MM  | 1  | PZ         |                              |  |      |             |                          |     |          |                          |                    |    |          |                 |              |    |          |                              |                 |   |          |                                |                              |       |          |                |                |    |          |                                 |                                   |    |          |                                   |  |    |          |   |                       |    |          |                       |                   |    |          |                   |   |    |
| VL1128A0  | BARBED CHECK VALVE D6                    | 1  | PZ         |                              |  |      |             |                          |     |          |                          |                    |    |          |                 |              |    |          |                              |                 |   |          |                                |                              |       |          |                |                |    |          |                                 |                                   |    |          |                                   |  |    |          |   |                       |    |          |                       |                   |    |          |                   |   |    |
| VM2172A0  | PUMP LOCKING CLIP                        | 1  | PZ         |                              |  |      |             |                          |     |          |                          |                    |    |          |                 |              |    |          |                              |                 |   |          |                                |                              |       |          |                |                |    |          |                                 |                                   |    |          |                                   |  |    |          |   |                       |    |          |                       |                   |    |          |                   |   |    |
| KVL1092A  | EUR 2 ROTOR ARMS PLUS CHEMICAL PUMP KIT  | <table border="1"> <thead> <tr> <th>Code</th> <th>Description</th> <th>Qty</th> <th>UOM</th> </tr> </thead> <tbody> <tr> <td>GN1526A0</td> <td>INT. D.=6.9 TH=1.8 O-RIN</td> <td>1</td> <td>PZ</td> </tr> <tr> <td>RC1019A0</td> <td>D=10 ELASTIC CLAMP</td> <td>6</td> <td>PZ</td> </tr> <tr> <td>RC1130A0</td> <td>130X2,6 CLAM</td> <td>1</td> <td>PZ</td> </tr> <tr> <td>RC1242A0</td> <td>D=10 CLOSED CAP</td> <td>2</td> <td>PZ</td> </tr> <tr> <td>TB2820A0</td> <td>PIPE EPDM FOR WASHING SYSTEM</td> <td>0.120</td> <td>M</td> </tr> <tr> <td>VL1019A0</td> <td>VIBRATION PUMP</td> <td>1</td> <td>PZ</td> </tr> <tr> <td>VL1067A0</td> <td>WASHING SYSTEM INLETS DISTRIBUTOR</td> <td>1</td> <td>PZ</td> </tr> <tr> <td>VL1092A0</td> <td>WASHING SYSTEM OUTLET DOUBLE DISTRIBUTOR</td> <td>1</td> <td>PZ</td> </tr> <tr> <td>VL1128A0</td> <td>BARBED CHECK VALVE D6</td> <td>1</td> <td>PZ</td> </tr> <tr> <td>VM2172A0</td> <td>PUMP LOCKING CLIP</td> <td>1</td> <td>PZ</td> </tr> </tbody> </table> | Code       | Description                  | Qty  | UOM  | GN1526A0    | INT. D.=6.9 TH=1.8 O-RIN | 1   | PZ       | RC1019A0                 | D=10 ELASTIC CLAMP | 6  | PZ       | RC1130A0        | 130X2,6 CLAM | 1  | PZ       | RC1242A0                     | D=10 CLOSED CAP | 2 | PZ       | TB2820A0                       | PIPE EPDM FOR WASHING SYSTEM | 0.120 | M        | VL1019A0       | VIBRATION PUMP | 1  | PZ       | VL1067A0                        | WASHING SYSTEM INLETS DISTRIBUTOR | 1  | PZ       | VL1092A0                          | WASHING SYSTEM OUTLET DOUBLE DISTRIBUTOR | 1  | PZ       | VL1128A0                                | BARBED CHECK VALVE D6 | 1  | PZ       | VM2172A0              | PUMP LOCKING CLIP | 1  | PZ       |                   |   |    |
| Code      | Description                              | Qty  | UOM        |                              |  |      |             |                          |     |          |                          |                    |    |          |                 |              |    |          |                              |                 |   |          |                                |                              |       |          |                |                |    |          |                                 |                                   |    |          |                                   |  |    |          |   |                       |    |          |                       |                   |    |          |                   |   |    |
| GN1526A0  | INT. D.=6.9 TH=1.8 O-RIN                 | 1  | PZ         |                              |  |      |             |                          |     |          |                          |                    |    |          |                 |              |    |          |                              |                 |   |          |                                |                              |       |          |                |                |    |          |                                 |                                   |    |          |                                   |  |    |          |   |                       |    |          |                       |                   |    |          |                   |   |    |
| RC1019A0  | D=10 ELASTIC CLAMP                       | 6  | PZ         |                              |  |      |             |                          |     |          |                          |                    |    |          |                 |              |    |          |                              |                 |   |          |                                |                              |       |          |                |                |    |          |                                 |                                   |    |          |                                   |  |    |          |   |                       |    |          |                       |                   |    |          |                   |   |    |
| RC1130A0  | 130X2,6 CLAM                             | 1  | PZ         |                              |  |      |             |                          |     |          |                          |                    |    |          |                 |              |    |          |                              |                 |   |          |                                |                              |       |          |                |                |    |          |                                 |                                   |    |          |                                   |  |    |          |   |                       |    |          |                       |                   |    |          |                   |   |    |
| RC1242A0  | D=10 CLOSED CAP                          | 2  | PZ         |                              |  |      |             |                          |     |          |                          |                    |    |          |                 |              |    |          |                              |                 |   |          |                                |                              |       |          |                |                |    |          |                                 |                                   |    |          |                                   |  |    |          |   |                       |    |          |                       |                   |    |          |                   |   |    |
| TB2820A0  | PIPE EPDM FOR WASHING SYSTEM             | 0.120  | M          |                              |  |      |             |                          |     |          |                          |                    |    |          |                 |              |    |          |                              |                 |   |          |                                |                              |       |          |                |                |    |          |                                 |                                   |    |          |                                   |  |    |          |   |                       |    |          |                       |                   |    |          |                   |   |    |
| VL1019A0  | VIBRATION PUMP                           | 1  | PZ         |                              |  |      |             |                          |     |          |                          |                    |    |          |                 |              |    |          |                              |                 |   |          |                                |                              |       |          |                |                |    |          |                                 |                                   |    |          |                                   |  |    |          |   |                       |    |          |                       |                   |    |          |                   |   |    |
| VL1067A0  | WASHING SYSTEM INLETS DISTRIBUTOR        | 1  | PZ         |                              |  |      |             |                          |     |          |                          |                    |    |          |                 |              |    |          |                              |                 |   |          |                                |                              |       |          |                |                |    |          |                                 |                                   |    |          |                                   |  |    |          |   |                       |    |          |                       |                   |    |          |                   |   |    |
| VL1092A0  | WASHING SYSTEM OUTLET DOUBLE DISTRIBUTOR | 1  | PZ         |                              |  |      |             |                          |     |          |                          |                    |    |          |                 |              |    |          |                              |                 |   |          |                                |                              |       |          |                |                |    |          |                                 |                                   |    |          |                                   |  |    |          |   |                       |    |          |                       |                   |    |          |                   |   |    |
| VL1128A0  | BARBED CHECK VALVE D6                    | 1  | PZ         |                              |  |      |             |                          |     |          |                          |                    |    |          |                 |              |    |          |                              |                 |   |          |                                |                              |       |          |                |                |    |          |                                 |                                   |    |          |                                   |  |    |          |   |                       |    |          |                       |                   |    |          |                   |   |    |
| VM2172A0  | PUMP LOCKING CLIP                        | 1  | PZ         |                              |  |      |             |                          |     |          |                          |                    |    |          |                 |              |    |          |                              |                 |   |          |                                |                              |       |          |                |                |    |          |                                 |                                   |    |          |                                   |  |    |          |   |                       |    |          |                       |                   |    |          |                   |   |    |

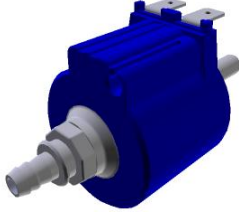
| COMPONENT |                                    |   | SPARE PART |  |  |      |             |                          |     |          |                          |                    |    |          |                    |                 |    |          |              |                              |       |          |                 |                                |    |          |                              |                |   |          |                |                                 |    |          |                                    |                                   |    |          |                                   |                       |    |          |                       |                   |    |          |                   |   |    |
|-----------|------------------------------------|---|------------|--|--|------|-------------|--------------------------|-----|----------|--------------------------|--------------------|----|----------|--------------------|-----------------|----|----------|--------------|------------------------------|-------|----------|-----------------|--------------------------------|----|----------|------------------------------|----------------|---|----------|----------------|---------------------------------|----|----------|------------------------------------|-----------------------------------|----|----------|-----------------------------------|-----------------------|----|----------|-----------------------|-------------------|----|----------|-------------------|---|----|
| Code      | Description                        | Image   | Code       | Description                            | Components list  |      |             |                          |     |          |                          |                    |    |          |                    |                 |    |          |              |                              |       |          |                 |                                |    |          |                              |                |   |          |                |                                 |    |          |                                    |                                   |    |          |                                   |                       |    |          |                       |                   |    |          |                   |   |    |
| VL1019A   | VIBRATION PUMP                     |    | KVL1073A   | EUR 1 ROTOR ARM PLUS CHEMICAL PUMP KIT | <table border="1"> <thead> <tr> <th>Code</th> <th>Description</th> <th>Qty</th> <th>UOM</th> </tr> </thead> <tbody> <tr> <td>GN1526A0</td> <td>INT. D.=6.9 TH=1.8 O-RIN</td> <td>1</td> <td>PZ</td> </tr> <tr> <td>RC1019A0</td> <td>D=10 ELASTIC CLAMP</td> <td>6</td> <td>PZ</td> </tr> <tr> <td>RC1130A0</td> <td>130X2,6 CLAM</td> <td>1</td> <td>PZ</td> </tr> <tr> <td>RC1242A0</td> <td>D=10 CLOSED CAP</td> <td>2</td> <td>PZ</td> </tr> <tr> <td>TB2820A0</td> <td>PIPE EPDM FOR WASHING SYSTEM</td> <td>0.120</td> <td>M</td> </tr> <tr> <td>VL1019A0</td> <td>VIBRATION PUMP</td> <td>1</td> <td>PZ</td> </tr> <tr> <td>VL1064A0</td> <td>WASHING SYSTEM OUTLETS DISTRIBUTOR</td> <td>1</td> <td>PZ</td> </tr> <tr> <td>VL1067A0</td> <td>WASHING SYSTEM INLETS DISTRIBUTOR</td> <td>1</td> <td>PZ</td> </tr> <tr> <td>VL1128A0</td> <td>BARBED CHECK VALVE D6</td> <td>1</td> <td>PZ</td> </tr> <tr> <td>VM2172A0</td> <td>PUMP LOCKING CLIP</td> <td>1</td> <td>PZ</td> </tr> </tbody> </table> | Code | Description | Qty                      | UOM | GN1526A0 | INT. D.=6.9 TH=1.8 O-RIN | 1                  | PZ | RC1019A0 | D=10 ELASTIC CLAMP | 6               | PZ | RC1130A0 | 130X2,6 CLAM | 1                            | PZ    | RC1242A0 | D=10 CLOSED CAP | 2                              | PZ | TB2820A0 | PIPE EPDM FOR WASHING SYSTEM | 0.120          | M | VL1019A0 | VIBRATION PUMP | 1                               | PZ | VL1064A0 | WASHING SYSTEM OUTLETS DISTRIBUTOR | 1                                 | PZ | VL1067A0 | WASHING SYSTEM INLETS DISTRIBUTOR | 1                     | PZ | VL1128A0 | BARBED CHECK VALVE D6 | 1                 | PZ | VM2172A0 | PUMP LOCKING CLIP | 1 | PZ |
|           |                                    |   | Code       | Description                            | Qty  | UOM  |             |                          |     |          |                          |                    |    |          |                    |                 |    |          |              |                              |       |          |                 |                                |    |          |                              |                |   |          |                |                                 |    |          |                                    |                                   |    |          |                                   |                       |    |          |                       |                   |    |          |                   |   |    |
| GN1526A0  | INT. D.=6.9 TH=1.8 O-RIN           | 1   | PZ         |  |  |      |             |                          |     |          |                          |                    |    |          |                    |                 |    |          |              |                              |       |          |                 |                                |    |          |                              |                |   |          |                |                                 |    |          |                                    |                                   |    |          |                                   |                       |    |          |                       |                   |    |          |                   |   |    |
| RC1019A0  | D=10 ELASTIC CLAMP                 | 6   | PZ         |  |  |      |             |                          |     |          |                          |                    |    |          |                    |                 |    |          |              |                              |       |          |                 |                                |    |          |                              |                |   |          |                |                                 |    |          |                                    |                                   |    |          |                                   |                       |    |          |                       |                   |    |          |                   |   |    |
| RC1130A0  | 130X2,6 CLAM                       | 1   | PZ         |  |  |      |             |                          |     |          |                          |                    |    |          |                    |                 |    |          |              |                              |       |          |                 |                                |    |          |                              |                |   |          |                |                                 |    |          |                                    |                                   |    |          |                                   |                       |    |          |                       |                   |    |          |                   |   |    |
| RC1242A0  | D=10 CLOSED CAP                    | 2   | PZ         |  |  |      |             |                          |     |          |                          |                    |    |          |                    |                 |    |          |              |                              |       |          |                 |                                |    |          |                              |                |   |          |                |                                 |    |          |                                    |                                   |    |          |                                   |                       |    |          |                       |                   |    |          |                   |   |    |
| TB2820A0  | PIPE EPDM FOR WASHING SYSTEM       | 0.120   | M          |  |  |      |             |                          |     |          |                          |                    |    |          |                    |                 |    |          |              |                              |       |          |                 |                                |    |          |                              |                |   |          |                |                                 |    |          |                                    |                                   |    |          |                                   |                       |    |          |                       |                   |    |          |                   |   |    |
| VL1019A0  | VIBRATION PUMP                     | 1   | PZ         |  |  |      |             |                          |     |          |                          |                    |    |          |                    |                 |    |          |              |                              |       |          |                 |                                |    |          |                              |                |   |          |                |                                 |    |          |                                    |                                   |    |          |                                   |                       |    |          |                       |                   |    |          |                   |   |    |
| VL1064A0  | WASHING SYSTEM OUTLETS DISTRIBUTOR | 1   | PZ         |  |  |      |             |                          |     |          |                          |                    |    |          |                    |                 |    |          |              |                              |       |          |                 |                                |    |          |                              |                |   |          |                |                                 |    |          |                                    |                                   |    |          |                                   |                       |    |          |                       |                   |    |          |                   |   |    |
| VL1067A0  | WASHING SYSTEM INLETS DISTRIBUTOR  | 1   | PZ         |  |  |      |             |                          |     |          |                          |                    |    |          |                    |                 |    |          |              |                              |       |          |                 |                                |    |          |                              |                |   |          |                |                                 |    |          |                                    |                                   |    |          |                                   |                       |    |          |                       |                   |    |          |                   |   |    |
| VL1128A0  | BARBED CHECK VALVE D6              | 1   | PZ         |  |  |      |             |                          |     |          |                          |                    |    |          |                    |                 |    |          |              |                              |       |          |                 |                                |    |          |                              |                |   |          |                |                                 |    |          |                                    |                                   |    |          |                                   |                       |    |          |                       |                   |    |          |                   |   |    |
| VM2172A0  | PUMP LOCKING CLIP                  | 1   | PZ         |  |  |      |             |                          |     |          |                          |                    |    |          |                    |                 |    |          |              |                              |       |          |                 |                                |    |          |                              |                |   |          |                |                                 |    |          |                                    |                                   |    |          |                                   |                       |    |          |                       |                   |    |          |                   |   |    |
| KVL1072A  | ONE SERIES CHEMICAL PUMP KI        | <table border="1"> <thead> <tr> <th>Code</th> <th>Description</th> <th>Qty</th> <th>UOM</th> </tr> </thead> <tbody> <tr> <td>GN1526A0</td> <td>INT. D.=6.9 TH=1.8 O-RIN</td> <td>1</td> <td>PZ</td> </tr> <tr> <td>RC1019A0</td> <td>D=10 ELASTIC CLAMP</td> <td>6</td> <td>PZ</td> </tr> <tr> <td>RC1242A0</td> <td>D=10 CLOSED CAP</td> <td>2</td> <td>PZ</td> </tr> <tr> <td>TB2820A0</td> <td>PIPE EPDM FOR WASHING SYSTEM</td> <td>0.120</td> <td>M</td> </tr> <tr> <td>VI1220A1</td> <td>4,2X12 TCB SELF-TAPPIN G SCREW</td> <td>1</td> <td>PZ</td> </tr> <tr> <td>VL1019A0</td> <td>VIBRATION PUMP</td> <td>1</td> <td>PZ</td> </tr> <tr> <td>VL1053B0</td> <td>ONE WASHING SYS EXT DISTRIBUTOR</td> <td>1</td> <td>PZ</td> </tr> <tr> <td>VL1054B0</td> <td>ONE WASHING SYS INLET DISTRIBUTOR</td> <td>1</td> <td>PZ</td> </tr> <tr> <td>VL1128A0</td> <td>BARBED CHECK VALVE D6</td> <td>1</td> <td>PZ</td> </tr> <tr> <td>VM2172A0</td> <td>PUMP LOCKING CLIP</td> <td>1</td> <td>PZ</td> </tr> </tbody> </table> | Code       | Description                            | Qty  | UOM  | GN1526A0    | INT. D.=6.9 TH=1.8 O-RIN | 1   | PZ       | RC1019A0                 | D=10 ELASTIC CLAMP | 6  | PZ       | RC1242A0           | D=10 CLOSED CAP | 2  | PZ       | TB2820A0     | PIPE EPDM FOR WASHING SYSTEM | 0.120 | M        | VI1220A1        | 4,2X12 TCB SELF-TAPPIN G SCREW | 1  | PZ       | VL1019A0                     | VIBRATION PUMP | 1 | PZ       | VL1053B0       | ONE WASHING SYS EXT DISTRIBUTOR | 1  | PZ       | VL1054B0                           | ONE WASHING SYS INLET DISTRIBUTOR | 1  | PZ       | VL1128A0                          | BARBED CHECK VALVE D6 | 1  | PZ       | VM2172A0              | PUMP LOCKING CLIP | 1  | PZ       |                   |   |    |
| Code      | Description                        | Qty   | UOM        |  |  |      |             |                          |     |          |                          |                    |    |          |                    |                 |    |          |              |                              |       |          |                 |                                |    |          |                              |                |   |          |                |                                 |    |          |                                    |                                   |    |          |                                   |                       |    |          |                       |                   |    |          |                   |   |    |
| GN1526A0  | INT. D.=6.9 TH=1.8 O-RIN           | 1   | PZ         |  |  |      |             |                          |     |          |                          |                    |    |          |                    |                 |    |          |              |                              |       |          |                 |                                |    |          |                              |                |   |          |                |                                 |    |          |                                    |                                   |    |          |                                   |                       |    |          |                       |                   |    |          |                   |   |    |
| RC1019A0  | D=10 ELASTIC CLAMP                 | 6   | PZ         |  |  |      |             |                          |     |          |                          |                    |    |          |                    |                 |    |          |              |                              |       |          |                 |                                |    |          |                              |                |   |          |                |                                 |    |          |                                    |                                   |    |          |                                   |                       |    |          |                       |                   |    |          |                   |   |    |
| RC1242A0  | D=10 CLOSED CAP                    | 2   | PZ         |  |  |      |             |                          |     |          |                          |                    |    |          |                    |                 |    |          |              |                              |       |          |                 |                                |    |          |                              |                |   |          |                |                                 |    |          |                                    |                                   |    |          |                                   |                       |    |          |                       |                   |    |          |                   |   |    |
| TB2820A0  | PIPE EPDM FOR WASHING SYSTEM       | 0.120   | M          |  |  |      |             |                          |     |          |                          |                    |    |          |                    |                 |    |          |              |                              |       |          |                 |                                |    |          |                              |                |   |          |                |                                 |    |          |                                    |                                   |    |          |                                   |                       |    |          |                       |                   |    |          |                   |   |    |
| VI1220A1  | 4,2X12 TCB SELF-TAPPIN G SCREW     | 1   | PZ         |  |  |      |             |                          |     |          |                          |                    |    |          |                    |                 |    |          |              |                              |       |          |                 |                                |    |          |                              |                |   |          |                |                                 |    |          |                                    |                                   |    |          |                                   |                       |    |          |                       |                   |    |          |                   |   |    |
| VL1019A0  | VIBRATION PUMP                     | 1   | PZ         |  |  |      |             |                          |     |          |                          |                    |    |          |                    |                 |    |          |              |                              |       |          |                 |                                |    |          |                              |                |   |          |                |                                 |    |          |                                    |                                   |    |          |                                   |                       |    |          |                       |                   |    |          |                   |   |    |
| VL1053B0  | ONE WASHING SYS EXT DISTRIBUTOR    | 1   | PZ         |  |  |      |             |                          |     |          |                          |                    |    |          |                    |                 |    |          |              |                              |       |          |                 |                                |    |          |                              |                |   |          |                |                                 |    |          |                                    |                                   |    |          |                                   |                       |    |          |                       |                   |    |          |                   |   |    |
| VL1054B0  | ONE WASHING SYS INLET DISTRIBUTOR  | 1   | PZ         |  |  |      |             |                          |     |          |                          |                    |    |          |                    |                 |    |          |              |                              |       |          |                 |                                |    |          |                              |                |   |          |                |                                 |    |          |                                    |                                   |    |          |                                   |                       |    |          |                       |                   |    |          |                   |   |    |
| VL1128A0  | BARBED CHECK VALVE D6              | 1   | PZ         |  |  |      |             |                          |     |          |                          |                    |    |          |                    |                 |    |          |              |                              |       |          |                 |                                |    |          |                              |                |   |          |                |                                 |    |          |                                    |                                   |    |          |                                   |                       |    |          |                       |                   |    |          |                   |   |    |
| VM2172A0  | PUMP LOCKING CLIP                  | 1   | PZ         |  |  |      |             |                          |     |          |                          |                    |    |          |                    |                 |    |          |              |                              |       |          |                 |                                |    |          |                              |                |   |          |                |                                 |    |          |                                    |                                   |    |          |                                   |                       |    |          |                       |                   |    |          |                   |   |    |





| COMPONENT |   |   | SPARE PART |                            |  |      |             |     |     |          |  |   |    |          |   |   |    |          |                          |   |    |          |                    |   |    |          |                 |   |    |          |                         |   |    |          |                           |       |   |          |                              |       |   |          |                                |   |    |          |                |   |    |          |                             |   |    |          |                                   |   |    |          |                                 |   |    |          |                                   |   |    |          |   |   |    |          |                       |   |    |          |                                |   |    |          |                             |   |    |
|-----------|---|---|------------|----------------------------|--|------|-------------|-----|-----|----------|--|---|----|----------|---|---|----|----------|--------------------------|---|----|----------|--------------------|---|----|----------|-----------------|---|----|----------|-------------------------|---|----|----------|---------------------------|-------|---|----------|------------------------------|-------|---|----------|--------------------------------|---|----|----------|----------------|---|----|----------|-----------------------------|---|----|----------|-----------------------------------|---|----|----------|---------------------------------|---|----|----------|-----------------------------------|---|----|----------|---|---|----|----------|-----------------------|---|----|----------|--------------------------------|---|----|----------|-----------------------------|---|----|
| Code      | Description                             | Image   | Code       | Description                | Components list  |      |             |     |     |          |  |   |    |          |   |   |    |          |                          |   |    |          |                    |   |    |          |                 |   |    |          |                         |   |    |          |                           |       |   |          |                              |       |   |          |                                |   |    |          |                |   |    |          |                             |   |    |          |                                   |   |    |          |                                 |   |    |          |                                   |   |    |          |   |   |    |          |                       |   |    |          |                                |   |    |          |                             |   |    |
| VL1019A   | VIBRATION PUMP                          |  | KVL0001A   | LM TOP CLEANING SYSTEM KIT | <table border="1"> <thead> <tr> <th>Code</th> <th>Description</th> <th>Qty</th> <th>UOM</th> </tr> </thead> <tbody> <tr> <td>0H1226B0</td> <td>LINEMISSTOP WASHING SYTEM CIRCUIT COVE</td> <td>1</td> <td>PZ</td> </tr> <tr> <td>GN1312A0</td> <td>RUBBER CABLE-PASSI NG DE=26 DI=15 SP=10</td> <td>1</td> <td>PZ</td> </tr> <tr> <td>GN1526A0</td> <td>INT. D.=6.9 TH=1.8 O-RIN</td> <td>1</td> <td>PZ</td> </tr> <tr> <td>RC1019A0</td> <td>D=10 ELASTIC CLAMP</td> <td>5</td> <td>PZ</td> </tr> <tr> <td>RC1242A0</td> <td>D=10 CLOSED CAP</td> <td>2</td> <td>PZ</td> </tr> <tr> <td>RC1381A0</td> <td>BIFILAR PIPE CLIP D10.7</td> <td>3</td> <td>PZ</td> </tr> <tr> <td>TB2343A0</td> <td>9X6 PVC TRANSPAREN T PIPE</td> <td>1.650</td> <td>M</td> </tr> <tr> <td>TB2820A0</td> <td>PIPE EPDM FOR WASHING SYSTEM</td> <td>0.990</td> <td>M</td> </tr> <tr> <td>VH1220A1</td> <td>4,2X12 TCB SELF-TAPPIN G SCREW</td> <td>1</td> <td>PZ</td> </tr> <tr> <td>VL1019A0</td> <td>VIBRATION PUMP</td> <td>1</td> <td>PZ</td> </tr> <tr> <td>VL1041C0</td> <td>DETERGENT CAP WITH Ø12 HOLE</td> <td>1</td> <td>PZ</td> </tr> <tr> <td>VL1047A1</td> <td>D6 PIPE HOLDER - D8 J.G. TERMINAL</td> <td>1</td> <td>PZ</td> </tr> <tr> <td>VL1053B0</td> <td>ONE WASHING SYS EXT DISTRIBUTOR</td> <td>1</td> <td>PZ</td> </tr> <tr> <td>VL1054B0</td> <td>ONE WASHING SYS INLET DISTRIBUTOR</td> <td>1</td> <td>PZ</td> </tr> <tr> <td>VL1061A0</td> <td>HOLD DOWN WEIGHT+NET FILTER+NON-RET. V.</td> <td>1</td> <td>PZ</td> </tr> <tr> <td>VL1128A0</td> <td>BARBED CHECK VALVE D6</td> <td>2</td> <td>PZ</td> </tr> <tr> <td>VM1066A0</td> <td>SADDLE CLIP FOR CABLES PASSING</td> <td>3</td> <td>PZ</td> </tr> <tr> <td>VM1088A0</td> <td>NYLON CLICK CLAMP D7.9-D9.2</td> <td>1</td> <td>PZ</td> </tr> </tbody> </table> | Code | Description | Qty | UOM | 0H1226B0 | LINEMISSTOP WASHING SYTEM CIRCUIT COVE | 1 | PZ | GN1312A0 | RUBBER CABLE-PASSI NG DE=26 DI=15 SP=10 | 1 | PZ | GN1526A0 | INT. D.=6.9 TH=1.8 O-RIN | 1 | PZ | RC1019A0 | D=10 ELASTIC CLAMP | 5 | PZ | RC1242A0 | D=10 CLOSED CAP | 2 | PZ | RC1381A0 | BIFILAR PIPE CLIP D10.7 | 3 | PZ | TB2343A0 | 9X6 PVC TRANSPAREN T PIPE | 1.650 | M | TB2820A0 | PIPE EPDM FOR WASHING SYSTEM | 0.990 | M | VH1220A1 | 4,2X12 TCB SELF-TAPPIN G SCREW | 1 | PZ | VL1019A0 | VIBRATION PUMP | 1 | PZ | VL1041C0 | DETERGENT CAP WITH Ø12 HOLE | 1 | PZ | VL1047A1 | D6 PIPE HOLDER - D8 J.G. TERMINAL | 1 | PZ | VL1053B0 | ONE WASHING SYS EXT DISTRIBUTOR | 1 | PZ | VL1054B0 | ONE WASHING SYS INLET DISTRIBUTOR | 1 | PZ | VL1061A0 | HOLD DOWN WEIGHT+NET FILTER+NON-RET. V. | 1 | PZ | VL1128A0 | BARBED CHECK VALVE D6 | 2 | PZ | VM1066A0 | SADDLE CLIP FOR CABLES PASSING | 3 | PZ | VM1088A0 | NYLON CLICK CLAMP D7.9-D9.2 | 1 | PZ |
| Code      | Description                             | Qty   | UOM        |                            |  |      |             |     |     |          |  |   |    |          |   |   |    |          |                          |   |    |          |                    |   |    |          |                 |   |    |          |                         |   |    |          |                           |       |   |          |                              |       |   |          |                                |   |    |          |                |   |    |          |                             |   |    |          |                                   |   |    |          |                                 |   |    |          |                                   |   |    |          |   |   |    |          |                       |   |    |          |                                |   |    |          |                             |   |    |
| 0H1226B0  | LINEMISSTOP WASHING SYTEM CIRCUIT COVE  | 1   | PZ         |                            |  |      |             |     |     |          |  |   |    |          |   |   |    |          |                          |   |    |          |                    |   |    |          |                 |   |    |          |                         |   |    |          |                           |       |   |          |                              |       |   |          |                                |   |    |          |                |   |    |          |                             |   |    |          |                                   |   |    |          |                                 |   |    |          |                                   |   |    |          |   |   |    |          |                       |   |    |          |                                |   |    |          |                             |   |    |
| GN1312A0  | RUBBER CABLE-PASSI NG DE=26 DI=15 SP=10 | 1   | PZ         |                            |  |      |             |     |     |          |  |   |    |          |   |   |    |          |                          |   |    |          |                    |   |    |          |                 |   |    |          |                         |   |    |          |                           |       |   |          |                              |       |   |          |                                |   |    |          |                |   |    |          |                             |   |    |          |                                   |   |    |          |                                 |   |    |          |                                   |   |    |          |   |   |    |          |                       |   |    |          |                                |   |    |          |                             |   |    |
| GN1526A0  | INT. D.=6.9 TH=1.8 O-RIN                | 1   | PZ         |                            |  |      |             |     |     |          |  |   |    |          |   |   |    |          |                          |   |    |          |                    |   |    |          |                 |   |    |          |                         |   |    |          |                           |       |   |          |                              |       |   |          |                                |   |    |          |                |   |    |          |                             |   |    |          |                                   |   |    |          |                                 |   |    |          |                                   |   |    |          |   |   |    |          |                       |   |    |          |                                |   |    |          |                             |   |    |
| RC1019A0  | D=10 ELASTIC CLAMP                      | 5   | PZ         |                            |  |      |             |     |     |          |  |   |    |          |   |   |    |          |                          |   |    |          |                    |   |    |          |                 |   |    |          |                         |   |    |          |                           |       |   |          |                              |       |   |          |                                |   |    |          |                |   |    |          |                             |   |    |          |                                   |   |    |          |                                 |   |    |          |                                   |   |    |          |   |   |    |          |                       |   |    |          |                                |   |    |          |                             |   |    |
| RC1242A0  | D=10 CLOSED CAP                         | 2   | PZ         |                            |  |      |             |     |     |          |  |   |    |          |   |   |    |          |                          |   |    |          |                    |   |    |          |                 |   |    |          |                         |   |    |          |                           |       |   |          |                              |       |   |          |                                |   |    |          |                |   |    |          |                             |   |    |          |                                   |   |    |          |                                 |   |    |          |                                   |   |    |          |   |   |    |          |                       |   |    |          |                                |   |    |          |                             |   |    |
| RC1381A0  | BIFILAR PIPE CLIP D10.7                 | 3   | PZ         |                            |  |      |             |     |     |          |  |   |    |          |   |   |    |          |                          |   |    |          |                    |   |    |          |                 |   |    |          |                         |   |    |          |                           |       |   |          |                              |       |   |          |                                |   |    |          |                |   |    |          |                             |   |    |          |                                   |   |    |          |                                 |   |    |          |                                   |   |    |          |   |   |    |          |                       |   |    |          |                                |   |    |          |                             |   |    |
| TB2343A0  | 9X6 PVC TRANSPAREN T PIPE               | 1.650   | M          |                            |  |      |             |     |     |          |  |   |    |          |   |   |    |          |                          |   |    |          |                    |   |    |          |                 |   |    |          |                         |   |    |          |                           |       |   |          |                              |       |   |          |                                |   |    |          |                |   |    |          |                             |   |    |          |                                   |   |    |          |                                 |   |    |          |                                   |   |    |          |   |   |    |          |                       |   |    |          |                                |   |    |          |                             |   |    |
| TB2820A0  | PIPE EPDM FOR WASHING SYSTEM            | 0.990   | M          |                            |  |      |             |     |     |          |  |   |    |          |   |   |    |          |                          |   |    |          |                    |   |    |          |                 |   |    |          |                         |   |    |          |                           |       |   |          |                              |       |   |          |                                |   |    |          |                |   |    |          |                             |   |    |          |                                   |   |    |          |                                 |   |    |          |                                   |   |    |          |   |   |    |          |                       |   |    |          |                                |   |    |          |                             |   |    |
| VH1220A1  | 4,2X12 TCB SELF-TAPPIN G SCREW          | 1   | PZ         |                            |  |      |             |     |     |          |  |   |    |          |   |   |    |          |                          |   |    |          |                    |   |    |          |                 |   |    |          |                         |   |    |          |                           |       |   |          |                              |       |   |          |                                |   |    |          |                |   |    |          |                             |   |    |          |                                   |   |    |          |                                 |   |    |          |                                   |   |    |          |   |   |    |          |                       |   |    |          |                                |   |    |          |                             |   |    |
| VL1019A0  | VIBRATION PUMP                          | 1   | PZ         |                            |  |      |             |     |     |          |  |   |    |          |   |   |    |          |                          |   |    |          |                    |   |    |          |                 |   |    |          |                         |   |    |          |                           |       |   |          |                              |       |   |          |                                |   |    |          |                |   |    |          |                             |   |    |          |                                   |   |    |          |                                 |   |    |          |                                   |   |    |          |   |   |    |          |                       |   |    |          |                                |   |    |          |                             |   |    |
| VL1041C0  | DETERGENT CAP WITH Ø12 HOLE             | 1   | PZ         |                            |  |      |             |     |     |          |  |   |    |          |   |   |    |          |                          |   |    |          |                    |   |    |          |                 |   |    |          |                         |   |    |          |                           |       |   |          |                              |       |   |          |                                |   |    |          |                |   |    |          |                             |   |    |          |                                   |   |    |          |                                 |   |    |          |                                   |   |    |          |   |   |    |          |                       |   |    |          |                                |   |    |          |                             |   |    |
| VL1047A1  | D6 PIPE HOLDER - D8 J.G. TERMINAL       | 1   | PZ         |                            |  |      |             |     |     |          |  |   |    |          |   |   |    |          |                          |   |    |          |                    |   |    |          |                 |   |    |          |                         |   |    |          |                           |       |   |          |                              |       |   |          |                                |   |    |          |                |   |    |          |                             |   |    |          |                                   |   |    |          |                                 |   |    |          |                                   |   |    |          |   |   |    |          |                       |   |    |          |                                |   |    |          |                             |   |    |
| VL1053B0  | ONE WASHING SYS EXT DISTRIBUTOR         | 1   | PZ         |                            |  |      |             |     |     |          |  |   |    |          |   |   |    |          |                          |   |    |          |                    |   |    |          |                 |   |    |          |                         |   |    |          |                           |       |   |          |                              |       |   |          |                                |   |    |          |                |   |    |          |                             |   |    |          |                                   |   |    |          |                                 |   |    |          |                                   |   |    |          |   |   |    |          |                       |   |    |          |                                |   |    |          |                             |   |    |
| VL1054B0  | ONE WASHING SYS INLET DISTRIBUTOR       | 1   | PZ         |                            |  |      |             |     |     |          |  |   |    |          |   |   |    |          |                          |   |    |          |                    |   |    |          |                 |   |    |          |                         |   |    |          |                           |       |   |          |                              |       |   |          |                                |   |    |          |                |   |    |          |                             |   |    |          |                                   |   |    |          |                                 |   |    |          |                                   |   |    |          |   |   |    |          |                       |   |    |          |                                |   |    |          |                             |   |    |
| VL1061A0  | HOLD DOWN WEIGHT+NET FILTER+NON-RET. V. | 1   | PZ         |                            |  |      |             |     |     |          |  |   |    |          |   |   |    |          |                          |   |    |          |                    |   |    |          |                 |   |    |          |                         |   |    |          |                           |       |   |          |                              |       |   |          |                                |   |    |          |                |   |    |          |                             |   |    |          |                                   |   |    |          |                                 |   |    |          |                                   |   |    |          |   |   |    |          |                       |   |    |          |                                |   |    |          |                             |   |    |
| VL1128A0  | BARBED CHECK VALVE D6                   | 2   | PZ         |                            |  |      |             |     |     |          |  |   |    |          |   |   |    |          |                          |   |    |          |                    |   |    |          |                 |   |    |          |                         |   |    |          |                           |       |   |          |                              |       |   |          |                                |   |    |          |                |   |    |          |                             |   |    |          |                                   |   |    |          |                                 |   |    |          |                                   |   |    |          |   |   |    |          |                       |   |    |          |                                |   |    |          |                             |   |    |
| VM1066A0  | SADDLE CLIP FOR CABLES PASSING          | 3   | PZ         |                            |  |      |             |     |     |          |  |   |    |          |   |   |    |          |                          |   |    |          |                    |   |    |          |                 |   |    |          |                         |   |    |          |                           |       |   |          |                              |       |   |          |                                |   |    |          |                |   |    |          |                             |   |    |          |                                   |   |    |          |                                 |   |    |          |                                   |   |    |          |   |   |    |          |                       |   |    |          |                                |   |    |          |                             |   |    |
| VM1088A0  | NYLON CLICK CLAMP D7.9-D9.2             | 1   | PZ         |                            |  |      |             |     |     |          |  |   |    |          |   |   |    |          |                          |   |    |          |                    |   |    |          |                 |   |    |          |                         |   |    |          |                           |       |   |          |                              |       |   |          |                                |   |    |          |                |   |    |          |                             |   |    |          |                                   |   |    |          |                                 |   |    |          |                                   |   |    |          |   |   |    |          |                       |   |    |          |                                |   |    |          |                             |   |    |

| COMPONENT |                                    |   | SPARE PART |  |   |      |             |     |     |          |                                    |    |    |          |                              |       |    |          |                       |   |    |
|-----------|------------------------------------|---|------------|--|---|------|-------------|-----|-----|----------|------------------------------------|----|----|----------|------------------------------|-------|----|----------|-----------------------|---|----|
| Code      | Description                        | Image   | Code       | Description                              | Components list   |      |             |     |     |          |                                    |    |    |          |                              |       |    |          |                       |   |    |
| VL1019A   | VIBRATION PUMP                     |    | KVL0001A   | LM TOP CLEANING SYSTEM KIT               | <table border="1"> <thead> <tr> <th>Code</th> <th>Description</th> <th>Qty</th> <th>UOM</th> </tr> </thead> <tbody> <tr> <td>VM1605A0</td> <td>CLIP TWIST LOCK DIAM. 10,2-12,7 MM</td> <td>1</td> <td>PZ</td> </tr> <tr> <td>VM2172A0</td> <td>PUMP LOCKING CLIP</td> <td>1</td> <td>PZ</td> </tr> </tbody> </table>  | Code | Description | Qty | UOM | VM1605A0 | CLIP TWIST LOCK DIAM. 10,2-12,7 MM | 1  | PZ | VM2172A0 | PUMP LOCKING CLIP            | 1     | PZ |          |                       |   |    |
| Code      | Description                        | Qty   | UOM        |  |   |      |             |     |     |          |                                    |    |    |          |                              |       |    |          |                       |   |    |
| VM1605A0  | CLIP TWIST LOCK DIAM. 10,2-12,7 MM | 1   | PZ         |  |   |      |             |     |     |          |                                    |    |    |          |                              |       |    |          |                       |   |    |
| VM2172A0  | PUMP LOCKING CLIP                  | 1   | PZ         |  |   |      |             |     |     |          |                                    |    |    |          |                              |       |    |          |                       |   |    |
| VM2172A   | PUMP LOCKING CLI                   |   | VM2172A0   | PUMP LOCKING CLI                         |   |      |             |     |     |          |                                    |    |    |          |                              |       |    |          |                       |   |    |
| RC1019A   | D=10 ELASTIC CLAM                  |  | KRC1019A   | Ø10 ZINC PLATED ELASTIC CLAMP 15 PCS KIT | <table border="1"> <thead> <tr> <th>Code</th> <th>Description</th> <th>Qty</th> <th>UOM</th> </tr> </thead> <tbody> <tr> <td>RC1019A0</td> <td>D=10 ELASTIC CLAMP</td> <td>17</td> <td>PZ</td> </tr> </tbody> </table>  | Code | Description | Qty | UOM | RC1019A0 | D=10 ELASTIC CLAMP                 | 17 | PZ |          |                              |       |    |          |                       |   |    |
| Code      | Description                        | Qty   | UOM        |  |   |      |             |     |     |          |                                    |    |    |          |                              |       |    |          |                       |   |    |
| RC1019A0  | D=10 ELASTIC CLAMP                 | 17  | PZ         |  |   |      |             |     |     |          |                                    |    |    |          |                              |       |    |          |                       |   |    |
| VL1081A   | D6 BARBED NO RETURN VALVE          |  | KVL1128A   | D6 VNR BARBED VALVE KIT                  | <table border="1"> <thead> <tr> <th>Code</th> <th>Description</th> <th>Qty</th> <th>UOM</th> </tr> </thead> <tbody> <tr> <td>RC1019A0</td> <td>D=10 ELASTIC CLAMP</td> <td>4</td> <td>PZ</td> </tr> <tr> <td>TB2820A0</td> <td>PIPE EPDM FOR WASHING SYSTEM</td> <td>0.080</td> <td>M</td> </tr> <tr> <td>VL1128A0</td> <td>BARBED CHECK VALVE D6</td> <td>1</td> <td>PZ</td> </tr> </tbody> </table> | Code | Description | Qty | UOM | RC1019A0 | D=10 ELASTIC CLAMP                 | 4  | PZ | TB2820A0 | PIPE EPDM FOR WASHING SYSTEM | 0.080 | M  | VL1128A0 | BARBED CHECK VALVE D6 | 1 | PZ |
| Code      | Description                        | Qty   | UOM        |  |   |      |             |     |     |          |                                    |    |    |          |                              |       |    |          |                       |   |    |
| RC1019A0  | D=10 ELASTIC CLAMP                 | 4   | PZ         |  |   |      |             |     |     |          |                                    |    |    |          |                              |       |    |          |                       |   |    |
| TB2820A0  | PIPE EPDM FOR WASHING SYSTEM       | 0.080   | M          |  |   |      |             |     |     |          |                                    |    |    |          |                              |       |    |          |                       |   |    |
| VL1128A0  | BARBED CHECK VALVE D6              | 1   | PZ         |  |   |      |             |     |     |          |                                    |    |    |          |                              |       |    |          |                       |   |    |
| RC1242A   | D=10 CLOSED CAP                    |  | KRC1242A   | Ø10 CLOSED CONNECTION 20PCS KIT          | <table border="1"> <thead> <tr> <th>Code</th> <th>Description</th> <th>Qty</th> <th>UOM</th> </tr> </thead> <tbody> <tr> <td>RC1242A0</td> <td>D=10 CLOSED CAP</td> <td>20</td> <td>PZ</td> </tr> </tbody> </table>   | Code | Description | Qty | UOM | RC1242A0 | D=10 CLOSED CAP                    | 20 | PZ |          |                              |       |    |          |                       |   |    |
| Code      | Description                        | Qty   | UOM        |  |   |      |             |     |     |          |                                    |    |    |          |                              |       |    |          |                       |   |    |
| RC1242A0  | D=10 CLOSED CAP                    | 20  | PZ         |  |   |      |             |     |     |          |                                    |    |    |          |                              |       |    |          |                       |   |    |





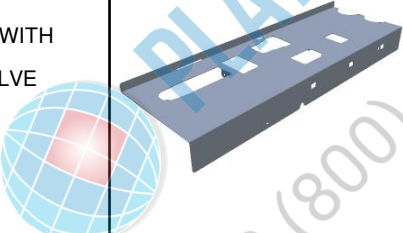

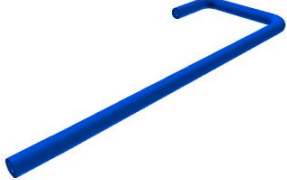

| COMPONENT |  |   | SPARE PART |  |   |      |             |     |     |          |  |   |    |          |                       |   |    |          |                    |   |    |          |                                    |       |   |          |                                      |   |    |          |                   |   |    |          |  |   |    |          |  |   |    |          |                             |   |    |          |                      |   |    |
|-----------|--|---|------------|--|---|------|-------------|-----|-----|----------|--|---|----|----------|-----------------------|---|----|----------|--------------------|---|----|----------|------------------------------------|-------|---|----------|--------------------------------------|---|----|----------|-------------------|---|----|----------|--|---|----|----------|--|---|----|----------|-----------------------------|---|----|----------|----------------------|---|----|
| Code      | Description                                | Image   | Code       | Description                                    | Components list   |      |             |     |     |          |  |   |    |          |                       |   |    |          |                    |   |    |          |                                    |       |   |          |                                      |   |    |          |                   |   |    |          |  |   |    |          |  |   |    |          |                             |   |    |          |                      |   |    |
| VL1054B   | ONE WASHING SYS<br>INLET DISTRIBUTOR       |    | KVL1054B   | ONE WASHING<br>SYST INLETS<br>DISTRIBUTOR KIT  | <table border="1"> <thead> <tr> <th>Code</th> <th>Description</th> <th>Qty</th> <th>UOM</th> </tr> </thead> <tbody> <tr> <td>VL1054B0</td> <td>ONE<br/>WASHING SYS<br/>INLET<br/>DISTRIBUTOR</td> <td>1</td> <td>PZ</td> </tr> </tbody> </table>  | Code | Description | Qty | UOM | VL1054B0 | ONE<br>WASHING SYS<br>INLET<br>DISTRIBUTOR | 1 | PZ |          |                       |   |    |          |                    |   |    |          |                                    |       |   |          |                                      |   |    |          |                   |   |    |          |  |   |    |          |  |   |    |          |                             |   |    |          |                      |   |    |
| Code      | Description                                | Qty   | UOM        |  |   |      |             |     |     |          |  |   |    |          |                       |   |    |          |                    |   |    |          |                                    |       |   |          |                                      |   |    |          |                   |   |    |          |  |   |    |          |  |   |    |          |                             |   |    |          |                      |   |    |
| VL1054B0  | ONE<br>WASHING SYS<br>INLET<br>DISTRIBUTOR | 1   | PZ         |  |   |      |             |     |     |          |  |   |    |          |                       |   |    |          |                    |   |    |          |                                    |       |   |          |                                      |   |    |          |                   |   |    |          |  |   |    |          |  |   |    |          |                             |   |    |          |                      |   |    |
| VL1053B   | ONE WASHING SYS<br>EXT DISTRIBUTOR         |    | KVL1072A   | ONE SERIES<br>CHEMICAL PUMP KI                 | <table border="1"> <thead> <tr> <th>Code</th> <th>Description</th> <th>Qty</th> <th>UOM</th> </tr> </thead> <tbody> <tr> <td>GN1526A0</td> <td>INT. D.=6.9<br/>TH=1.8 O-RIN</td> <td>1</td> <td>PZ</td> </tr> <tr> <td>RC1019A0</td> <td>D=10 ELASTIC<br/>CLAMP</td> <td>6</td> <td>PZ</td> </tr> <tr> <td>RC1242A0</td> <td>D=10 CLOSED<br/>CAP</td> <td>2</td> <td>PZ</td> </tr> <tr> <td>TB2820A0</td> <td>PIPE EPDM<br/>FOR WASHING<br/>SYSTEM</td> <td>0.120</td> <td>M</td> </tr> <tr> <td>VI1220A1</td> <td>4,2X12 TCB<br/>SELF-TAPPIN<br/>G SCREW</td> <td>1</td> <td>PZ</td> </tr> <tr> <td>VL1019A0</td> <td>VIBRATION<br/>PUMP</td> <td>1</td> <td>PZ</td> </tr> <tr> <td>VL1053B0</td> <td>ONE<br/>WASHING SYS<br/>EXT<br/>DISTRIBUTOR</td> <td>1</td> <td>PZ</td> </tr> <tr> <td>VL1054B0</td> <td>ONE<br/>WASHING SYS<br/>INLET<br/>DISTRIBUTOR</td> <td>1</td> <td>PZ</td> </tr> <tr> <td>VL1128A0</td> <td>BARBED<br/>CHECK VALVE<br/>D6</td> <td>1</td> <td>PZ</td> </tr> <tr> <td>VM2172A0</td> <td>PUMP<br/>LOCKING CLIP</td> <td>1</td> <td>PZ</td> </tr> </tbody> </table> | Code | Description | Qty | UOM | GN1526A0 | INT. D.=6.9<br>TH=1.8 O-RIN                | 1 | PZ | RC1019A0 | D=10 ELASTIC<br>CLAMP | 6 | PZ | RC1242A0 | D=10 CLOSED<br>CAP | 2 | PZ | TB2820A0 | PIPE EPDM<br>FOR WASHING<br>SYSTEM | 0.120 | M | VI1220A1 | 4,2X12 TCB<br>SELF-TAPPIN<br>G SCREW | 1 | PZ | VL1019A0 | VIBRATION<br>PUMP | 1 | PZ | VL1053B0 | ONE<br>WASHING SYS<br>EXT<br>DISTRIBUTOR | 1 | PZ | VL1054B0 | ONE<br>WASHING SYS<br>INLET<br>DISTRIBUTOR | 1 | PZ | VL1128A0 | BARBED<br>CHECK VALVE<br>D6 | 1 | PZ | VM2172A0 | PUMP<br>LOCKING CLIP | 1 | PZ |
| Code      | Description                                | Qty   | UOM        |  |   |      |             |     |     |          |  |   |    |          |                       |   |    |          |                    |   |    |          |                                    |       |   |          |                                      |   |    |          |                   |   |    |          |  |   |    |          |  |   |    |          |                             |   |    |          |                      |   |    |
| GN1526A0  | INT. D.=6.9<br>TH=1.8 O-RIN                | 1   | PZ         |  |   |      |             |     |     |          |  |   |    |          |                       |   |    |          |                    |   |    |          |                                    |       |   |          |                                      |   |    |          |                   |   |    |          |  |   |    |          |  |   |    |          |                             |   |    |          |                      |   |    |
| RC1019A0  | D=10 ELASTIC<br>CLAMP                      | 6   | PZ         |  |   |      |             |     |     |          |  |   |    |          |                       |   |    |          |                    |   |    |          |                                    |       |   |          |                                      |   |    |          |                   |   |    |          |  |   |    |          |  |   |    |          |                             |   |    |          |                      |   |    |
| RC1242A0  | D=10 CLOSED<br>CAP                         | 2   | PZ         |  |   |      |             |     |     |          |  |   |    |          |                       |   |    |          |                    |   |    |          |                                    |       |   |          |                                      |   |    |          |                   |   |    |          |  |   |    |          |  |   |    |          |                             |   |    |          |                      |   |    |
| TB2820A0  | PIPE EPDM<br>FOR WASHING<br>SYSTEM         | 0.120   | M          |  |   |      |             |     |     |          |  |   |    |          |                       |   |    |          |                    |   |    |          |                                    |       |   |          |                                      |   |    |          |                   |   |    |          |  |   |    |          |  |   |    |          |                             |   |    |          |                      |   |    |
| VI1220A1  | 4,2X12 TCB<br>SELF-TAPPIN<br>G SCREW       | 1   | PZ         |  |   |      |             |     |     |          |  |   |    |          |                       |   |    |          |                    |   |    |          |                                    |       |   |          |                                      |   |    |          |                   |   |    |          |  |   |    |          |  |   |    |          |                             |   |    |          |                      |   |    |
| VL1019A0  | VIBRATION<br>PUMP                          | 1   | PZ         |  |   |      |             |     |     |          |  |   |    |          |                       |   |    |          |                    |   |    |          |                                    |       |   |          |                                      |   |    |          |                   |   |    |          |  |   |    |          |  |   |    |          |                             |   |    |          |                      |   |    |
| VL1053B0  | ONE<br>WASHING SYS<br>EXT<br>DISTRIBUTOR   | 1   | PZ         |  |   |      |             |     |     |          |  |   |    |          |                       |   |    |          |                    |   |    |          |                                    |       |   |          |                                      |   |    |          |                   |   |    |          |  |   |    |          |  |   |    |          |                             |   |    |          |                      |   |    |
| VL1054B0  | ONE<br>WASHING SYS<br>INLET<br>DISTRIBUTOR | 1   | PZ         |  |   |      |             |     |     |          |  |   |    |          |                       |   |    |          |                    |   |    |          |                                    |       |   |          |                                      |   |    |          |                   |   |    |          |  |   |    |          |  |   |    |          |                             |   |    |          |                      |   |    |
| VL1128A0  | BARBED<br>CHECK VALVE<br>D6                | 1   | PZ         |  |   |      |             |     |     |          |  |   |    |          |                       |   |    |          |                    |   |    |          |                                    |       |   |          |                                      |   |    |          |                   |   |    |          |  |   |    |          |  |   |    |          |                             |   |    |          |                      |   |    |
| VM2172A0  | PUMP<br>LOCKING CLIP                       | 1   | PZ         |  |   |      |             |     |     |          |  |   |    |          |                       |   |    |          |                    |   |    |          |                                    |       |   |          |                                      |   |    |          |                   |   |    |          |  |   |    |          |  |   |    |          |                             |   |    |          |                      |   |    |
| RC1408A   | DOUBLE WIRE<br>SPRING CLAMP<br>D10.8 ZN    |  | KRC1408A   | 4 PCS D10.8<br>DOUBLE WIRE<br>SPRING CLAMP KIT | <table border="1"> <thead> <tr> <th>Code</th> <th>Description</th> <th>Qty</th> <th>UOM</th> </tr> </thead> <tbody> <tr> <td>RC1408A0</td> <td>DOUBLE WIRE<br/>SPRING<br/>CLAMP D10.8<br/>ZN</td> <td>4</td> <td>PZ</td> </tr> </tbody> </table>  | Code | Description | Qty | UOM | RC1408A0 | DOUBLE WIRE<br>SPRING<br>CLAMP D10.8<br>ZN | 4 | PZ |          |                       |   |    |          |                    |   |    |          |                                    |       |   |          |                                      |   |    |          |                   |   |    |          |  |   |    |          |  |   |    |          |                             |   |    |          |                      |   |    |
| Code      | Description                                | Qty   | UOM        |  |   |      |             |     |     |          |  |   |    |          |                       |   |    |          |                    |   |    |          |                                    |       |   |          |                                      |   |    |          |                   |   |    |          |  |   |    |          |  |   |    |          |                             |   |    |          |                      |   |    |
| RC1408A0  | DOUBLE WIRE<br>SPRING<br>CLAMP D10.8<br>ZN | 4   | PZ         |  |   |      |             |     |     |          |  |   |    |          |                       |   |    |          |                    |   |    |          |                                    |       |   |          |                                      |   |    |          |                   |   |    |          |  |   |    |          |  |   |    |          |                             |   |    |          |                      |   |    |

| COMPONENT |  |   | SPARE PART |  |   |      |             |     |     |          |                                |    |    |          |                              |       |   |          |   |   |    |
|-----------|--|---|------------|--|---|------|-------------|-----|-----|----------|--------------------------------|----|----|----------|------------------------------|-------|---|----------|---|---|----|
| Code      | Description                              | Image   | Code       | Description                              | Components list   |      |             |     |     |          |                                |    |    |          |                              |       |   |          |   |   |    |
| EL1436A   | H2O SOLENOID JG D8 CHECK VALVE           |    | KEL1436A   | D8 CONNECTION D6 SOLEN.VALVE KIT         | <table border="1"> <thead> <tr> <th>Code</th> <th>Description</th> <th>Qty</th> <th>UOM</th> </tr> </thead> <tbody> <tr> <td>EL1436A0</td> <td>H2O SOLENOID JG D8 CHECK VALVE</td> <td>1</td> <td>PZ</td> </tr> </tbody> </table>   | Code | Description | Qty | UOM | EL1436A0 | H2O SOLENOID JG D8 CHECK VALVE | 1  | PZ |          |                              |       |   |          |   |   |    |
| Code      | Description                              | Qty   | UOM        |  |   |      |             |     |     |          |                                |    |    |          |                              |       |   |          |   |   |    |
| EL1436A0  | H2O SOLENOID JG D8 CHECK VALVE           | 1   | PZ         |  |   |      |             |     |     |          |                                |    |    |          |                              |       |   |          |   |   |    |
| TB3009B   | TB3132A-ONE OVEN WASHING INLET           |    | KTB1349A   | JGØ8 TB1818A WATER INLET PIPE L30M KIT   | <table border="1"> <thead> <tr> <th>Code</th> <th>Description</th> <th>Qty</th> <th>UOM</th> </tr> </thead> <tbody> <tr> <td>TB1818A0</td> <td>JG Ø8 BLUE PE PIPE</td> <td>30</td> <td>M</td> </tr> </tbody> </table>   | Code | Description | Qty | UOM | TB1818A0 | JG Ø8 BLUE PE PIPE             | 30 | M  |          |                              |       |   |          |   |   |    |
| Code      | Description                              | Qty   | UOM        |  |   |      |             |     |     |          |                                |    |    |          |                              |       |   |          |   |   |    |
| TB1818A0  | JG Ø8 BLUE PE PIPE                       | 30  | M          |  |   |      |             |     |     |          |                                |    |    |          |                              |       |   |          |   |   |    |
| 0H7819A   | ONE WASHING SYS SUPPORT WITH STEAM VALVE |  | 0H7819A0   | ONE WASHING SYS SUPPORT WITH STEAM VALVE |   |      |             |     |     |          |                                |    |    |          |                              |       |   |          |   |   |    |
| VL1102A   | DETERGENT LINE FILTER + BARBED VNR 6 MM  |  | KVL1102A   | DETERGENT FILTER + NRV KIT               | <table border="1"> <thead> <tr> <th>Code</th> <th>Description</th> <th>Qty</th> <th>UOM</th> </tr> </thead> <tbody> <tr> <td>RC1019A0</td> <td>D=10 ELASTIC CLAMP</td> <td>5</td> <td>PZ</td> </tr> <tr> <td>TB2820A0</td> <td>PIPE EPDM FOR WASHING SYSTEM</td> <td>0.710</td> <td>M</td> </tr> <tr> <td>VL1102A1</td> <td>DETERGENT LINE FILTER + BARBED VNR 6 MM</td> <td>1</td> <td>PZ</td> </tr> </tbody> </table> | Code | Description | Qty | UOM | RC1019A0 | D=10 ELASTIC CLAMP             | 5  | PZ | TB2820A0 | PIPE EPDM FOR WASHING SYSTEM | 0.710 | M | VL1102A1 | DETERGENT LINE FILTER + BARBED VNR 6 MM | 1 | PZ |
| Code      | Description                              | Qty   | UOM        |  |   |      |             |     |     |          |                                |    |    |          |                              |       |   |          |   |   |    |
| RC1019A0  | D=10 ELASTIC CLAMP                       | 5   | PZ         |  |   |      |             |     |     |          |                                |    |    |          |                              |       |   |          |   |   |    |
| TB2820A0  | PIPE EPDM FOR WASHING SYSTEM             | 0.710   | M          |  |   |      |             |     |     |          |                                |    |    |          |                              |       |   |          |   |   |    |
| VL1102A1  | DETERGENT LINE FILTER + BARBED VNR 6 MM  | 1   | PZ         |  |   |      |             |     |     |          |                                |    |    |          |                              |       |   |          |   |   |    |
| TB3256A   |  |  | TB3256A0   |  |   |      |             |     |     |          |                                |    |    |          |                              |       |   |          |   |   |    |

| COMPONENT |  |   | SPARE PART |   |   |      |             |     |     |          |                                       |   |    |          |                                     |   |    |          |  |   |    |          |                                       |   |    |          |                                      |   |    |
|-----------|--|---|------------|---|---|------|-------------|-----|-----|----------|---------------------------------------|---|----|----------|-------------------------------------|---|----|----------|--|---|----|----------|---------------------------------------|---|----|----------|--------------------------------------|---|----|
| Code      | Description                                  | Image   | Code       | Description                             | Components list   |      |             |     |     |          |                                       |   |    |          |                                     |   |    |          |  |   |    |          |                                       |   |    |          |                                      |   |    |
| 0E1352B   | XEVC-2011-E<br>EXTERNAL BOTTOM<br>PANEL      |    | 0E1352B0   | XEVC-2011-E<br>EXTERNAL BOTTOM<br>PANEL |   |      |             |     |     |          |                                       |   |    |          |                                     |   |    |          |  |   |    |          |                                       |   |    |          |                                      |   |    |
| TR1136A   | 330 °C 1 POLE<br>SAFETY<br>THERMOSTAT        |    | KTR1136A   | 330 °C SAFETY<br>THERMOSTAT KIT         | <table border="1"> <thead> <tr> <th>Code</th> <th>Description</th> <th>Qty</th> <th>UOM</th> </tr> </thead> <tbody> <tr> <td>0H7030A0</td> <td>THERMOSTAT<br/>BULB INLET<br/>COVER</td> <td>1</td> <td>PZ</td> </tr> <tr> <td>GN1531A0</td> <td>THERMOSTAT<br/>BULB INLET<br/>SEALING</td> <td>1</td> <td>PZ</td> </tr> <tr> <td>SL1045A0</td> <td>S53 BLACK<br/>SILICONE -<br/>80ML<br/>CARTRIDGE</td> <td>1</td> <td>PZ</td> </tr> <tr> <td>TR1136A0</td> <td>330 °C 1 POLE<br/>SAFETY<br/>THERMOSTAT</td> <td>1</td> <td>PZ</td> </tr> <tr> <td>VH1220A1</td> <td>4,2X12 TCB<br/>SELF-TAPPIN<br/>G SCREW</td> <td>3</td> <td>PZ</td> </tr> </tbody> </table> | Code | Description | Qty | UOM | 0H7030A0 | THERMOSTAT<br>BULB INLET<br>COVER     | 1 | PZ | GN1531A0 | THERMOSTAT<br>BULB INLET<br>SEALING | 1 | PZ | SL1045A0 | S53 BLACK<br>SILICONE -<br>80ML<br>CARTRIDGE | 1 | PZ | TR1136A0 | 330 °C 1 POLE<br>SAFETY<br>THERMOSTAT | 1 | PZ | VH1220A1 | 4,2X12 TCB<br>SELF-TAPPIN<br>G SCREW | 3 | PZ |
| Code      | Description                                  | Qty   | UOM        |   |   |      |             |     |     |          |                                       |   |    |          |                                     |   |    |          |  |   |    |          |                                       |   |    |          |                                      |   |    |
| 0H7030A0  | THERMOSTAT<br>BULB INLET<br>COVER            | 1   | PZ         |   |   |      |             |     |     |          |                                       |   |    |          |                                     |   |    |          |  |   |    |          |                                       |   |    |          |                                      |   |    |
| GN1531A0  | THERMOSTAT<br>BULB INLET<br>SEALING          | 1   | PZ         |   |   |      |             |     |     |          |                                       |   |    |          |                                     |   |    |          |  |   |    |          |                                       |   |    |          |                                      |   |    |
| SL1045A0  | S53 BLACK<br>SILICONE -<br>80ML<br>CARTRIDGE | 1   | PZ         |   |   |      |             |     |     |          |                                       |   |    |          |                                     |   |    |          |  |   |    |          |                                       |   |    |          |                                      |   |    |
| TR1136A0  | 330 °C 1 POLE<br>SAFETY<br>THERMOSTAT        | 1   | PZ         |   |   |      |             |     |     |          |                                       |   |    |          |                                     |   |    |          |  |   |    |          |                                       |   |    |          |                                      |   |    |
| VH1220A1  | 4,2X12 TCB<br>SELF-TAPPIN<br>G SCREW         | 3   | PZ         |   |   |      |             |     |     |          |                                       |   |    |          |                                     |   |    |          |  |   |    |          |                                       |   |    |          |                                      |   |    |
| VM2249A   | COOKING<br>CHAMBER FRONT<br>CORNER           |  | KVM2249A   | CHAMBER FRONT<br>PROFILE CORNER<br>KIT  | <table border="1"> <thead> <tr> <th>Code</th> <th>Description</th> <th>Qty</th> <th>UOM</th> </tr> </thead> <tbody> <tr> <td>VM2249A0</td> <td>COOKING<br/>CHAMBER<br/>FRONT<br/>CORNER</td> <td>1</td> <td>PZ</td> </tr> </tbody> </table>   | Code | Description | Qty | UOM | VM2249A0 | COOKING<br>CHAMBER<br>FRONT<br>CORNER | 1 | PZ |          |                                     |   |    |          |  |   |    |          |                                       |   |    |          |                                      |   |    |
| Code      | Description                                  | Qty   | UOM        |   |   |      |             |     |     |          |                                       |   |    |          |                                     |   |    |          |  |   |    |          |                                       |   |    |          |                                      |   |    |
| VM2249A0  | COOKING<br>CHAMBER<br>FRONT<br>CORNER        | 1   | PZ         |   |   |      |             |     |     |          |                                       |   |    |          |                                     |   |    |          |  |   |    |          |                                       |   |    |          |                                      |   |    |
| VM1810A   | WATER RIGHT<br>SEALING CAP                   |  | VM1810A0   | WATER RIGHT<br>SEALING CAP              |   |      |             |     |     |          |                                       |   |    |          |                                     |   |    |          |  |   |    |          |                                       |   |    |          |                                      |   |    |



| COMPONENT |                               |   | SPARE PART |                                       |   |      |             |     |     |          |                               |   |    |          |                             |   |    |          |                               |   |    |          |                               |   |    |
|-----------|-------------------------------|---|------------|---------------------------------------|---|------|-------------|-----|-----|----------|-------------------------------|---|----|----------|-----------------------------|---|----|----------|-------------------------------|---|----|----------|-------------------------------|---|----|
| Code      | Description                   | Image   | Code       | Description                           | Components list   |      |             |     |     |          |                               |   |    |          |                             |   |    |          |                               |   |    |          |                               |   |    |
| VM1811A   | WATER LEFT SEALING CAP        |    | VM1811A0   | WATER LEFT SEALING CAP                |   |      |             |     |     |          |                               |   |    |          |                             |   |    |          |                               |   |    |          |                               |   |    |
| VM2281A   | DOOR LATCH HOLES COVER        |    | KVM2281A   | HOLE PLATE COVER KIT                  | <table border="1"> <thead> <tr> <th>Code</th> <th>Description</th> <th>Qty</th> <th>UOM</th> </tr> </thead> <tbody> <tr> <td>VM2281A0</td> <td>DOOR LATCH HOLES COVER</td> <td>1</td> <td>PZ</td> </tr> </tbody> </table>   | Code | Description | Qty | UOM | VM2281A0 | DOOR LATCH HOLES COVER        | 1 | PZ |          |                             |   |    |          |                               |   |    |          |                               |   |    |
| Code      | Description                   | Qty   | UOM        |                                       |   |      |             |     |     |          |                               |   |    |          |                             |   |    |          |                               |   |    |          |                               |   |    |
| VM2281A0  | DOOR LATCH HOLES COVER        | 1   | PZ         |                                       |   |      |             |     |     |          |                               |   |    |          |                             |   |    |          |                               |   |    |          |                               |   |    |
| VL1026A   | BEND FOR DRAIN PIPE           |  | KVL1026A   | DRAIN PIPE BEND KIT                   | <table border="1"> <thead> <tr> <th>Code</th> <th>Description</th> <th>Qty</th> <th>UOM</th> </tr> </thead> <tbody> <tr> <td>GN1400A0</td> <td>U-TRAP SEAL</td> <td>1</td> <td>PZ</td> </tr> <tr> <td>VL1026A0</td> <td>BEND FOR DRAIN PIPE</td> <td>1</td> <td>PZ</td> </tr> <tr> <td>VM2039A0</td> <td>DRAIN BEND FIXING RING</td> <td>1</td> <td>PZ</td> </tr> </tbody> </table>   | Code | Description | Qty | UOM | GN1400A0 | U-TRAP SEAL                   | 1 | PZ | VL1026A0 | BEND FOR DRAIN PIPE         | 1 | PZ | VM2039A0 | DRAIN BEND FIXING RING        | 1 | PZ |          |                               |   |    |
| Code      | Description                   | Qty   | UOM        |                                       |   |      |             |     |     |          |                               |   |    |          |                             |   |    |          |                               |   |    |          |                               |   |    |
| GN1400A0  | U-TRAP SEAL                   | 1   | PZ         |                                       |   |      |             |     |     |          |                               |   |    |          |                             |   |    |          |                               |   |    |          |                               |   |    |
| VL1026A0  | BEND FOR DRAIN PIPE           | 1   | PZ         |                                       |   |      |             |     |     |          |                               |   |    |          |                             |   |    |          |                               |   |    |          |                               |   |    |
| VM2039A0  | DRAIN BEND FIXING RING        | 1   | PZ         |                                       |   |      |             |     |     |          |                               |   |    |          |                             |   |    |          |                               |   |    |          |                               |   |    |
| VM1505A   | WALL PASSING WITH DIAPHRAGM   |  | KVM1505A   | THROUGH-WALL CONNECTION+DIAPHRAGM KIT | <table border="1"> <thead> <tr> <th>Code</th> <th>Description</th> <th>Qty</th> <th>UOM</th> </tr> </thead> <tbody> <tr> <td>VI1220A1</td> <td>4,2X12 TCB SELF-TAPPING SCREW</td> <td>1</td> <td>PZ</td> </tr> <tr> <td>VM1505A0</td> <td>WALL PASSING WITH DIAPHRAGM</td> <td>3</td> <td>PZ</td> </tr> <tr> <td>VM2055A0</td> <td>UPPER THROUGH-WALL CONNECTION</td> <td>1</td> <td>PZ</td> </tr> <tr> <td>VM2056A0</td> <td>LOWER THROUGH-WALL CONNECTION</td> <td>1</td> <td>PZ</td> </tr> </tbody> </table> | Code | Description | Qty | UOM | VI1220A1 | 4,2X12 TCB SELF-TAPPING SCREW | 1 | PZ | VM1505A0 | WALL PASSING WITH DIAPHRAGM | 3 | PZ | VM2055A0 | UPPER THROUGH-WALL CONNECTION | 1 | PZ | VM2056A0 | LOWER THROUGH-WALL CONNECTION | 1 | PZ |
| Code      | Description                   | Qty   | UOM        |                                       |   |      |             |     |     |          |                               |   |    |          |                             |   |    |          |                               |   |    |          |                               |   |    |
| VI1220A1  | 4,2X12 TCB SELF-TAPPING SCREW | 1   | PZ         |                                       |   |      |             |     |     |          |                               |   |    |          |                             |   |    |          |                               |   |    |          |                               |   |    |
| VM1505A0  | WALL PASSING WITH DIAPHRAGM   | 3   | PZ         |                                       |   |      |             |     |     |          |                               |   |    |          |                             |   |    |          |                               |   |    |          |                               |   |    |
| VM2055A0  | UPPER THROUGH-WALL CONNECTION | 1   | PZ         |                                       |   |      |             |     |     |          |                               |   |    |          |                             |   |    |          |                               |   |    |          |                               |   |    |
| VM2056A0  | LOWER THROUGH-WALL CONNECTION | 1   | PZ         |                                       |   |      |             |     |     |          |                               |   |    |          |                             |   |    |          |                               |   |    |          |                               |   |    |

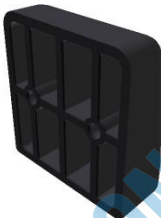

| COMPONENT |                                       |   | SPARE PART |  |   |      |             |     |     |          |                                       |   |    |
|-----------|---------------------------------------|---|------------|--|---|------|-------------|-----|-----|----------|---------------------------------------|---|----|
| Code      | Description                           | Image   | Code       | Description                                  | Components list   |      |             |     |     |          |                                       |   |    |
| VM1014A   | RING MOUNTING<br>OVEN TO THE FLOOR    |  | KVM1014A   | BRACKETS TO FIX<br>OVEN TO FLOOR<br>4PCS KIT | <table border="1"> <thead> <tr> <th>Code</th> <th>Description</th> <th>Qty</th> <th>UOM</th> </tr> </thead> <tbody> <tr> <td>VM1014A0</td> <td>RING MOUNTING<br/>OVEN TO THE<br/>FLOOR</td> <td>4</td> <td>PZ</td> </tr> </tbody> </table>  | Code | Description | Qty | UOM | VM1014A0 | RING MOUNTING<br>OVEN TO THE<br>FLOOR | 4 | PZ |
| Code      | Description                           | Qty   | UOM        |  |   |      |             |     |     |          |                                       |   |    |
| VM1014A0  | RING MOUNTING<br>OVEN TO THE<br>FLOOR | 4   | PZ         |  |   |      |             |     |     |          |                                       |   |    |
| VM2319A   | DOOR SUPPORT<br>PLASTIC BRACKET       |  | KVM2319A   | DOOR SUPPORT<br>CAP KIT                      | <table border="1"> <thead> <tr> <th>Code</th> <th>Description</th> <th>Qty</th> <th>UOM</th> </tr> </thead> <tbody> <tr> <td>VM2319A0</td> <td>DOOR<br/>SUPPORT<br/>PLASTIC<br/>BRACKET</td> <td>1</td> <td>PZ</td> </tr> </tbody> </table> | Code | Description | Qty | UOM | VM2319A0 | DOOR<br>SUPPORT<br>PLASTIC<br>BRACKET | 1 | PZ |
| Code      | Description                           | Qty   | UOM        |  |   |      |             |     |     |          |                                       |   |    |
| VM2319A0  | DOOR<br>SUPPORT<br>PLASTIC<br>BRACKET | 1   | PZ         |  |   |      |             |     |     |          |                                       |   |    |



PLATON SERVICE  
8 (800) 500-34-47  
www.platonservice.com



**ASM1804A/0.D02 - Cooking chamber**

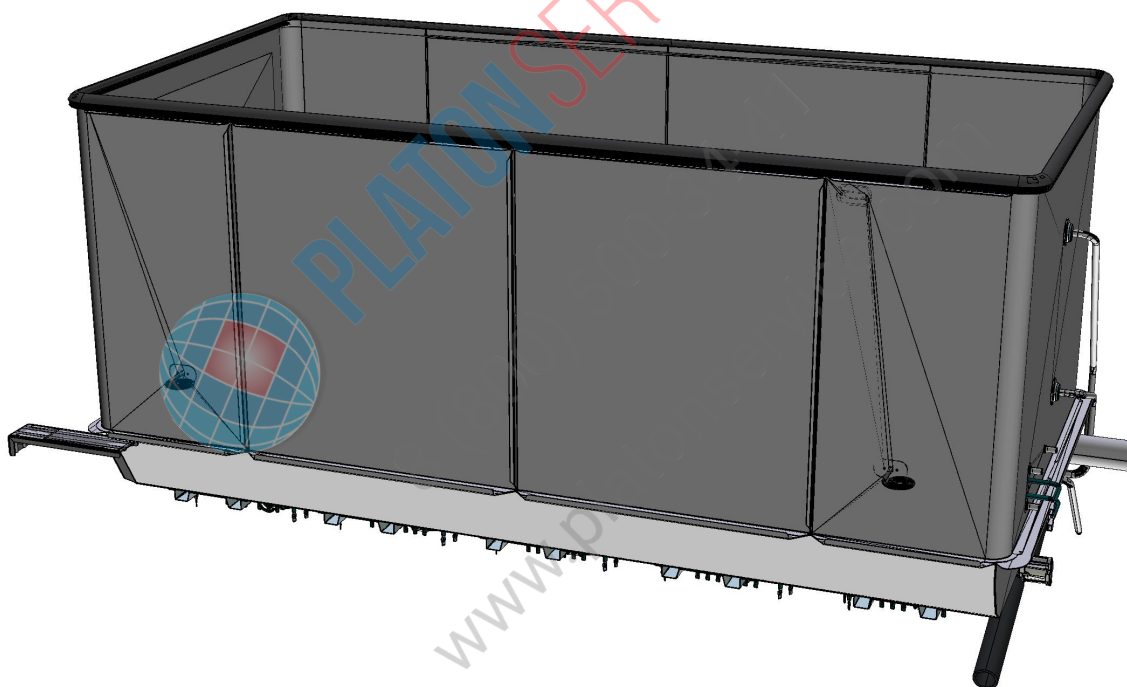

**FRONT**

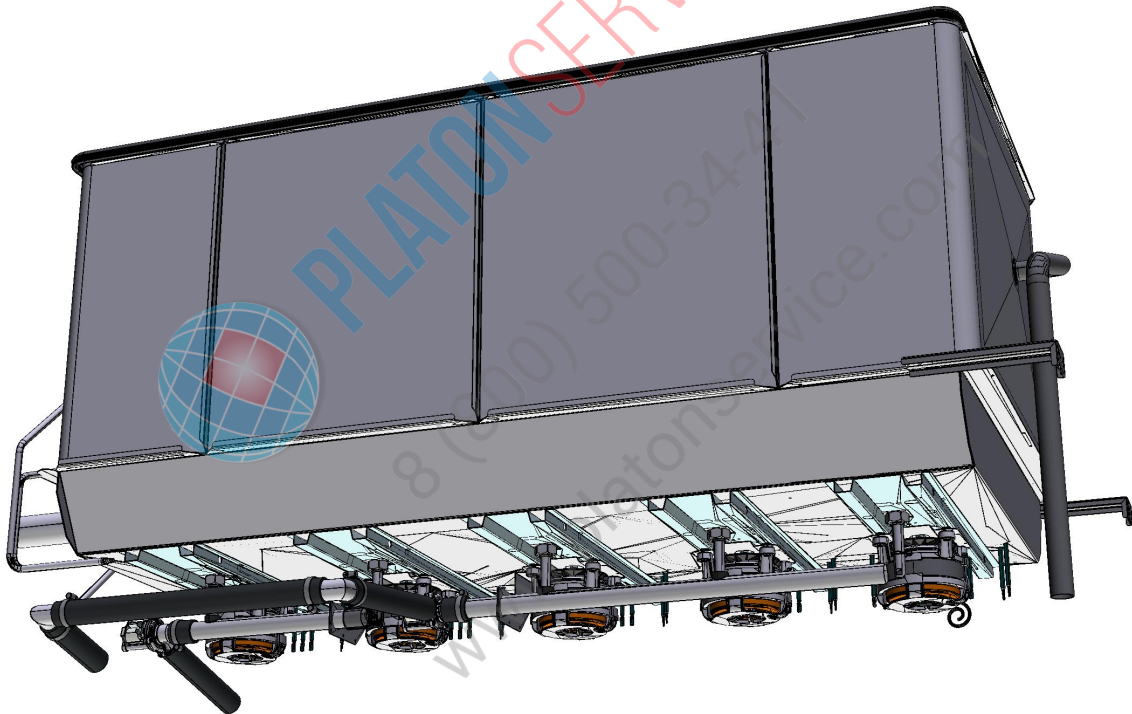

**ASM1804A/0.D02 - Cooking chamber**

**REAR**



| COMPONENT |  |   | SPARE PART |                                       |  |      |             |     |     |          |                    |   |    |          |  |   |    |          |  |   |    |          |                                      |   |    |          |   |   |    |
|-----------|--|---|------------|---------------------------------------|--|------|-------------|-----|-----|----------|--------------------|---|----|----------|--|---|----|----------|--|---|----|----------|--------------------------------------|---|----|----------|---|---|----|
| Code      | Description  | Image   | Code       | Description                           | Components list  |      |             |     |     |          |                    |   |    |          |  |   |    |          |  |   |    |          |                                      |   |    |          |   |   |    |
| RS1215A   | 147W 105V<br>BRAKING ELEMENT                         |    | KRS1215A   | 147W MOTOR<br>BRAKING ELEMENT<br>KIT  | <table border="1"> <thead> <tr> <th>Code</th> <th>Description</th> <th>Qty</th> <th>UOM</th> </tr> </thead> <tbody> <tr> <td>GN1326A1</td> <td>ELEMENT<br/>SEALING</td> <td>1</td> <td>PZ</td> </tr> <tr> <td>RS1215A1</td> <td>147W 105V<br/>BRAKING<br/>ELEMENT</td> <td>1</td> <td>PZ</td> </tr> <tr> <td>SL1045A0</td> <td>S53 BLACK<br/>SILICONE -<br/>80ML<br/>CARTRIDGE</td> <td>1</td> <td>PZ</td> </tr> <tr> <td>VI1220A1</td> <td>4,2X12 TCB<br/>SELF-TAPPIN<br/>G SCREW</td> <td>2</td> <td>PZ</td> </tr> </tbody> </table>   | Code | Description | Qty | UOM | GN1326A1 | ELEMENT<br>SEALING | 1 | PZ | RS1215A1 | 147W 105V<br>BRAKING<br>ELEMENT                      | 1 | PZ | SL1045A0 | S53 BLACK<br>SILICONE -<br>80ML<br>CARTRIDGE | 1 | PZ | VI1220A1 | 4,2X12 TCB<br>SELF-TAPPIN<br>G SCREW | 2 | PZ |          |   |   |    |
| Code      | Description  | Qty   | UOM        |                                       |  |      |             |     |     |          |                    |   |    |          |  |   |    |          |  |   |    |          |                                      |   |    |          |   |   |    |
| GN1326A1  | ELEMENT<br>SEALING                                   | 1   | PZ         |                                       |  |      |             |     |     |          |                    |   |    |          |  |   |    |          |  |   |    |          |                                      |   |    |          |   |   |    |
| RS1215A1  | 147W 105V<br>BRAKING<br>ELEMENT                      | 1   | PZ         |                                       |  |      |             |     |     |          |                    |   |    |          |  |   |    |          |  |   |    |          |                                      |   |    |          |   |   |    |
| SL1045A0  | S53 BLACK<br>SILICONE -<br>80ML<br>CARTRIDGE         | 1   | PZ         |                                       |  |      |             |     |     |          |                    |   |    |          |  |   |    |          |  |   |    |          |                                      |   |    |          |   |   |    |
| VI1220A1  | 4,2X12 TCB<br>SELF-TAPPIN<br>G SCREW                 | 2   | PZ         |                                       |  |      |             |     |     |          |                    |   |    |          |  |   |    |          |  |   |    |          |                                      |   |    |          |   |   |    |
| GN1326A   | ELEMENT SEALING                                      |   | KRS1274A   | 100W MOTOR<br>BRAKING ELEMENT<br>KIT  | <table border="1"> <thead> <tr> <th>Code</th> <th>Description</th> <th>Qty</th> <th>UOM</th> </tr> </thead> <tbody> <tr> <td>GN1326A1</td> <td>ELEMENT<br/>SEALING</td> <td>1</td> <td>PZ</td> </tr> <tr> <td>RS1274A0</td> <td>100W 60V 1<br/>TURN FLAT<br/>ELEMENT</td> <td>1</td> <td>PZ</td> </tr> <tr> <td>SL1045A0</td> <td>S53 BLACK<br/>SILICONE -<br/>80ML<br/>CARTRIDGE</td> <td>1</td> <td>PZ</td> </tr> <tr> <td>VI1220A1</td> <td>4,2X12 TCB<br/>SELF-TAPPIN<br/>G SCREW</td> <td>2</td> <td>PZ</td> </tr> </tbody> </table>  | Code | Description | Qty | UOM | GN1326A1 | ELEMENT<br>SEALING | 1 | PZ | RS1274A0 | 100W 60V 1<br>TURN FLAT<br>ELEMENT                   | 1 | PZ | SL1045A0 | S53 BLACK<br>SILICONE -<br>80ML<br>CARTRIDGE | 1 | PZ | VI1220A1 | 4,2X12 TCB<br>SELF-TAPPIN<br>G SCREW | 2 | PZ |          |   |   |    |
| Code      | Description  | Qty   | UOM        |                                       |  |      |             |     |     |          |                    |   |    |          |  |   |    |          |  |   |    |          |                                      |   |    |          |   |   |    |
| GN1326A1  | ELEMENT<br>SEALING                                   | 1   | PZ         |                                       |  |      |             |     |     |          |                    |   |    |          |  |   |    |          |  |   |    |          |                                      |   |    |          |   |   |    |
| RS1274A0  | 100W 60V 1<br>TURN FLAT<br>ELEMENT                   | 1   | PZ         |                                       |  |      |             |     |     |          |                    |   |    |          |  |   |    |          |  |   |    |          |                                      |   |    |          |   |   |    |
| SL1045A0  | S53 BLACK<br>SILICONE -<br>80ML<br>CARTRIDGE         | 1   | PZ         |                                       |  |      |             |     |     |          |                    |   |    |          |  |   |    |          |  |   |    |          |                                      |   |    |          |   |   |    |
| VI1220A1  | 4,2X12 TCB<br>SELF-TAPPIN<br>G SCREW                 | 2   | PZ         |                                       |  |      |             |     |     |          |                    |   |    |          |  |   |    |          |  |   |    |          |                                      |   |    |          |   |   |    |
|           |  |  | KRS1261A   | 122W MOTOR<br>BREAKING<br>ELEMENT KIT | <table border="1"> <thead> <tr> <th>Code</th> <th>Description</th> <th>Qty</th> <th>UOM</th> </tr> </thead> <tbody> <tr> <td>GN1326A1</td> <td>ELEMENT<br/>SEALING</td> <td>1</td> <td>PZ</td> </tr> <tr> <td>RS1261A0</td> <td>BAKERLUX\CH<br/>EFLUX<br/>MOTOR<br/>BREAKING<br/>ELEMENT</td> <td>1</td> <td>PZ</td> </tr> <tr> <td>SL1045A0</td> <td>S53 BLACK<br/>SILICONE -<br/>80ML<br/>CARTRIDGE</td> <td>1</td> <td>PZ</td> </tr> <tr> <td>VI1220A1</td> <td>4,2X12 TCB<br/>SELF-TAPPIN<br/>G SCREW</td> <td>2</td> <td>PZ</td> </tr> <tr> <td>VM2147A0</td> <td>ESD SPONGE<br/>PINK SMOOTH<br/>410X343X15 M</td> <td>1</td> <td>PZ</td> </tr> </tbody> </table> | Code | Description | Qty | UOM | GN1326A1 | ELEMENT<br>SEALING | 1 | PZ | RS1261A0 | BAKERLUX\CH<br>EFLUX<br>MOTOR<br>BREAKING<br>ELEMENT | 1 | PZ | SL1045A0 | S53 BLACK<br>SILICONE -<br>80ML<br>CARTRIDGE | 1 | PZ | VI1220A1 | 4,2X12 TCB<br>SELF-TAPPIN<br>G SCREW | 2 | PZ | VM2147A0 | ESD SPONGE<br>PINK SMOOTH<br>410X343X15 M | 1 | PZ |
| Code      | Description  | Qty   | UOM        |                                       |  |      |             |     |     |          |                    |   |    |          |  |   |    |          |  |   |    |          |                                      |   |    |          |   |   |    |
| GN1326A1  | ELEMENT<br>SEALING                                   | 1   | PZ         |                                       |  |      |             |     |     |          |                    |   |    |          |  |   |    |          |  |   |    |          |                                      |   |    |          |   |   |    |
| RS1261A0  | BAKERLUX\CH<br>EFLUX<br>MOTOR<br>BREAKING<br>ELEMENT | 1   | PZ         |                                       |  |      |             |     |     |          |                    |   |    |          |  |   |    |          |  |   |    |          |                                      |   |    |          |   |   |    |
| SL1045A0  | S53 BLACK<br>SILICONE -<br>80ML<br>CARTRIDGE         | 1   | PZ         |                                       |  |      |             |     |     |          |                    |   |    |          |  |   |    |          |  |   |    |          |                                      |   |    |          |   |   |    |
| VI1220A1  | 4,2X12 TCB<br>SELF-TAPPIN<br>G SCREW                 | 2   | PZ         |                                       |  |      |             |     |     |          |                    |   |    |          |  |   |    |          |  |   |    |          |                                      |   |    |          |   |   |    |
| VM2147A0  | ESD SPONGE<br>PINK SMOOTH<br>410X343X15 M            | 1   | PZ         |                                       |  |      |             |     |     |          |                    |   |    |          |  |   |    |          |  |   |    |          |                                      |   |    |          |   |   |    |
|           |  |   | KRS1215A   | 147W MOTOR<br>BRAKING ELEMENT<br>KIT  | <table border="1"> <thead> <tr> <th>Code</th> <th>Description</th> <th>Qty</th> <th>UOM</th> </tr> </thead> <tbody> <tr> <td>GN1326A1</td> <td>ELEMENT<br/>SEALING</td> <td>1</td> <td>PZ</td> </tr> <tr> <td>RS1215A1</td> <td>147W 105V<br/>BRAKING<br/>ELEMENT</td> <td>1</td> <td>PZ</td> </tr> </tbody> </table>  | Code | Description | Qty | UOM | GN1326A1 | ELEMENT<br>SEALING | 1 | PZ | RS1215A1 | 147W 105V<br>BRAKING<br>ELEMENT                      | 1 | PZ |          |  |   |    |          |                                      |   |    |          |   |   |    |
| Code      | Description  | Qty   | UOM        |                                       |  |      |             |     |     |          |                    |   |    |          |  |   |    |          |  |   |    |          |                                      |   |    |          |   |   |    |
| GN1326A1  | ELEMENT<br>SEALING                                   | 1   | PZ         |                                       |  |      |             |     |     |          |                    |   |    |          |  |   |    |          |  |   |    |          |                                      |   |    |          |   |   |    |
| RS1215A1  | 147W 105V<br>BRAKING<br>ELEMENT                      | 1   | PZ         |                                       |  |      |             |     |     |          |                    |   |    |          |  |   |    |          |  |   |    |          |                                      |   |    |          |   |   |    |







| COMPONENT |   |   | SPARE PART |                                     |  |      |             |                 |     |          |                                     |   |       |          |                                |                                     |    |    |          |                                     |   |    |          |                                |   |    |          |                       |       |   |
|-----------|---|---|------------|-------------------------------------|--|------|-------------|-----------------|-----|----------|-------------------------------------|---|-------|----------|--------------------------------|-------------------------------------|----|----|----------|-------------------------------------|---|----|----------|--------------------------------|---|----|----------|-----------------------|-------|---|
| Code      | Description                             | Image   | Code       | Description                         | Components list  |      |             |                 |     |          |                                     |   |       |          |                                |                                     |    |    |          |                                     |   |    |          |                                |   |    |          |                       |       |   |
| GN1326A   | ELEMENT SEALING                         |    | KRS1215A   | 147W MOTOR BRAKING ELEMENT KIT      | <table border="1"> <thead> <tr> <th>Code</th> <th>Description</th> <th>Qty</th> <th>UOM</th> </tr> </thead> <tbody> <tr> <td>SL1045A0</td> <td>S53 BLACK SILICONE - 80ML CARTRIDGE</td> <td>1</td> <td>PZ</td> </tr> <tr> <td>VI1220A1</td> <td>4,2X12 TCB SELF-TAPPIN G SCREW</td> <td>2</td> <td>PZ</td> </tr> </tbody> </table> | Code | Description | Qty             | UOM | SL1045A0 | S53 BLACK SILICONE - 80ML CARTRIDGE | 1                                       | PZ    | VI1220A1 | 4,2X12 TCB SELF-TAPPIN G SCREW | 2                                   | PZ |    |          |                                     |   |    |          |                                |   |    |          |                       |       |   |
|           |   |   | Code       | Description                         | Qty  | UOM  |             |                 |     |          |                                     |   |       |          |                                |                                     |    |    |          |                                     |   |    |          |                                |   |    |          |                       |       |   |
|           |   |   | SL1045A0   | S53 BLACK SILICONE - 80ML CARTRIDGE | 1  | PZ   |             |                 |     |          |                                     |   |       |          |                                |                                     |    |    |          |                                     |   |    |          |                                |   |    |          |                       |       |   |
| VI1220A1  | 4,2X12 TCB SELF-TAPPIN G SCREW          | 2   | PZ         |                                     |  |      |             |                 |     |          |                                     |   |       |          |                                |                                     |    |    |          |                                     |   |    |          |                                |   |    |          |                       |       |   |
| KRS1095A  | 1.2KW HEATING ELEMENT KIT               | <table border="1"> <thead> <tr> <th>Code</th> <th>Description</th> <th>Qty</th> <th>UOM</th> </tr> </thead> <tbody> <tr> <td>GN1326A1</td> <td>ELEMENT SEALING</td> <td>1</td> <td>PZ</td> </tr> <tr> <td>IP1385A1</td> <td>CORNER POLYSTYREN E PACKING 110X80X2000</td> <td>0.500</td> <td>M</td> </tr> <tr> <td>RS1095A1</td> <td>HEATING ELEMENT 1200W 230V</td> <td>1</td> <td>PZ</td> </tr> <tr> <td>SL1045A0</td> <td>S53 BLACK SILICONE - 80ML CARTRIDGE</td> <td>1</td> <td>PZ</td> </tr> <tr> <td>VI1220A1</td> <td>4,2X12 TCB SELF-TAPPIN G SCREW</td> <td>2</td> <td>PZ</td> </tr> <tr> <td>VM1059A1</td> <td>HEAT SHRINK FILM H800</td> <td>1.200</td> <td>M</td> </tr> </tbody> </table> | Code       | Description                         | Qty  | UOM  | GN1326A1    | ELEMENT SEALING | 1   | PZ       | IP1385A1                            | CORNER POLYSTYREN E PACKING 110X80X2000 | 0.500 | M        | RS1095A1                       | HEATING ELEMENT 1200W 230V          | 1  | PZ | SL1045A0 | S53 BLACK SILICONE - 80ML CARTRIDGE | 1 | PZ | VI1220A1 | 4,2X12 TCB SELF-TAPPIN G SCREW | 2 | PZ | VM1059A1 | HEAT SHRINK FILM H800 | 1.200 | M |
| Code      | Description                             | Qty   | UOM        |                                     |  |      |             |                 |     |          |                                     |   |       |          |                                |                                     |    |    |          |                                     |   |    |          |                                |   |    |          |                       |       |   |
| GN1326A1  | ELEMENT SEALING                         | 1   | PZ         |                                     |  |      |             |                 |     |          |                                     |   |       |          |                                |                                     |    |    |          |                                     |   |    |          |                                |   |    |          |                       |       |   |
| IP1385A1  | CORNER POLYSTYREN E PACKING 110X80X2000 | 0.500   | M          |                                     |  |      |             |                 |     |          |                                     |   |       |          |                                |                                     |    |    |          |                                     |   |    |          |                                |   |    |          |                       |       |   |
| RS1095A1  | HEATING ELEMENT 1200W 230V              | 1   | PZ         |                                     |  |      |             |                 |     |          |                                     |   |       |          |                                |                                     |    |    |          |                                     |   |    |          |                                |   |    |          |                       |       |   |
| SL1045A0  | S53 BLACK SILICONE - 80ML CARTRIDGE     | 1   | PZ         |                                     |  |      |             |                 |     |          |                                     |   |       |          |                                |                                     |    |    |          |                                     |   |    |          |                                |   |    |          |                       |       |   |
| VI1220A1  | 4,2X12 TCB SELF-TAPPIN G SCREW          | 2   | PZ         |                                     |  |      |             |                 |     |          |                                     |   |       |          |                                |                                     |    |    |          |                                     |   |    |          |                                |   |    |          |                       |       |   |
| VM1059A1  | HEAT SHRINK FILM H800                   | 1.200   | M          |                                     |  |      |             |                 |     |          |                                     |   |       |          |                                |                                     |    |    |          |                                     |   |    |          |                                |   |    |          |                       |       |   |
| KRS1012A  | 1365W 120V HEATING ELEMENT KIT          | <table border="1"> <thead> <tr> <th>Code</th> <th>Description</th> <th>Qty</th> <th>UOM</th> </tr> </thead> <tbody> <tr> <td>GN1326A1</td> <td>ELEMENT SEALING</td> <td>1</td> <td>PZ</td> </tr> <tr> <td>RS1012A0</td> <td>CIRCULAR ELEMENT 1365W 120V</td> <td>1</td> <td>PZ</td> </tr> <tr> <td>VI1220A1</td> <td>4,2X12 TCB SELF-TAPPIN G SCREW</td> <td>5</td> <td>PZ</td> </tr> <tr> <td>VM1794A0</td> <td>250X4.8 PA66 BLACK CLAMP</td> <td>2</td> <td>PZ</td> </tr> <tr> <td>VM2103A0</td> <td>CLAMP LOCK</td> <td>2</td> <td>PZ</td> </tr> </tbody> </table>   | Code       | Description                         | Qty  | UOM  | GN1326A1    | ELEMENT SEALING | 1   | PZ       | RS1012A0                            | CIRCULAR ELEMENT 1365W 120V             | 1     | PZ       | VI1220A1                       | 4,2X12 TCB SELF-TAPPIN G SCREW      | 5  | PZ | VM1794A0 | 250X4.8 PA66 BLACK CLAMP            | 2 | PZ | VM2103A0 | CLAMP LOCK                     | 2 | PZ |          |                       |       |   |
| Code      | Description                             | Qty   | UOM        |                                     |  |      |             |                 |     |          |                                     |   |       |          |                                |                                     |    |    |          |                                     |   |    |          |                                |   |    |          |                       |       |   |
| GN1326A1  | ELEMENT SEALING                         | 1   | PZ         |                                     |  |      |             |                 |     |          |                                     |   |       |          |                                |                                     |    |    |          |                                     |   |    |          |                                |   |    |          |                       |       |   |
| RS1012A0  | CIRCULAR ELEMENT 1365W 120V             | 1   | PZ         |                                     |  |      |             |                 |     |          |                                     |   |       |          |                                |                                     |    |    |          |                                     |   |    |          |                                |   |    |          |                       |       |   |
| VI1220A1  | 4,2X12 TCB SELF-TAPPIN G SCREW          | 5   | PZ         |                                     |  |      |             |                 |     |          |                                     |   |       |          |                                |                                     |    |    |          |                                     |   |    |          |                                |   |    |          |                       |       |   |
| VM1794A0  | 250X4.8 PA66 BLACK CLAMP                | 2   | PZ         |                                     |  |      |             |                 |     |          |                                     |   |       |          |                                |                                     |    |    |          |                                     |   |    |          |                                |   |    |          |                       |       |   |
| VM2103A0  | CLAMP LOCK                              | 2   | PZ         |                                     |  |      |             |                 |     |          |                                     |   |       |          |                                |                                     |    |    |          |                                     |   |    |          |                                |   |    |          |                       |       |   |
| KRS1011A  | ROBERTA/LISA HEATING ELEMENT KIT        | <table border="1"> <thead> <tr> <th>Code</th> <th>Description</th> <th>Qty</th> <th>UOM</th> </tr> </thead> <tbody> <tr> <td>GN1326A1</td> <td>ELEMENT SEALING</td> <td>1</td> <td>PZ</td> </tr> <tr> <td>RS1011A0</td> <td>2560W 220-230V HEATING ELEMENT</td> <td>1</td> <td>PZ</td> </tr> <tr> <td>SL1045A0</td> <td>S53 BLACK SILICONE - 80ML CARTRIDGE</td> <td>1</td> <td>PZ</td> </tr> <tr> <td>VI1220A1</td> <td>4,2X12 TCB SELF-TAPPIN G SCREW</td> <td>5</td> <td>PZ</td> </tr> </tbody> </table>   | Code       | Description                         | Qty  | UOM  | GN1326A1    | ELEMENT SEALING | 1   | PZ       | RS1011A0                            | 2560W 220-230V HEATING ELEMENT          | 1     | PZ       | SL1045A0                       | S53 BLACK SILICONE - 80ML CARTRIDGE | 1  | PZ | VI1220A1 | 4,2X12 TCB SELF-TAPPIN G SCREW      | 5 | PZ |          |                                |   |    |          |                       |       |   |
| Code      | Description                             | Qty   | UOM        |                                     |  |      |             |                 |     |          |                                     |   |       |          |                                |                                     |    |    |          |                                     |   |    |          |                                |   |    |          |                       |       |   |
| GN1326A1  | ELEMENT SEALING                         | 1   | PZ         |                                     |  |      |             |                 |     |          |                                     |   |       |          |                                |                                     |    |    |          |                                     |   |    |          |                                |   |    |          |                       |       |   |
| RS1011A0  | 2560W 220-230V HEATING ELEMENT          | 1   | PZ         |                                     |  |      |             |                 |     |          |                                     |   |       |          |                                |                                     |    |    |          |                                     |   |    |          |                                |   |    |          |                       |       |   |
| SL1045A0  | S53 BLACK SILICONE - 80ML CARTRIDGE     | 1   | PZ         |                                     |  |      |             |                 |     |          |                                     |   |       |          |                                |                                     |    |    |          |                                     |   |    |          |                                |   |    |          |                       |       |   |
| VI1220A1  | 4,2X12 TCB SELF-TAPPIN G SCREW          | 5   | PZ         |                                     |  |      |             |                 |     |          |                                     |   |       |          |                                |                                     |    |    |          |                                     |   |    |          |                                |   |    |          |                       |       |   |





| COMPONENT |                                      |   | SPARE PART |                                  |   |      |             |                 |     |          |                          |                                   |    |          |            |                                |    |    |          |                                      |   |    |          |                                |   |    |
|-----------|--------------------------------------|---|------------|----------------------------------|---|------|-------------|-----------------|-----|----------|--------------------------|-----------------------------------|----|----------|------------|--------------------------------|----|----|----------|--------------------------------------|---|----|----------|--------------------------------|---|----|
| Code      | Description                          | Image   | Code       | Description                      | Components list   |      |             |                 |     |          |                          |                                   |    |          |            |                                |    |    |          |                                      |   |    |          |                                |   |    |
| GN1326A   | ELEMENT SEALING                      |    | KRS1011A   | ROBERTA/LISA HEATING ELEMENT KIT | <table border="1"> <thead> <tr> <th>Code</th> <th>Description</th> <th>Qty</th> <th>UOM</th> </tr> </thead> <tbody> <tr> <td>VM1794A0</td> <td>250X4.8 PA66 BLACK CLAMP</td> <td>2</td> <td>PZ</td> </tr> <tr> <td>VM2103A0</td> <td>CLAMP LOCK</td> <td>2</td> <td>PZ</td> </tr> </tbody> </table> | Code | Description | Qty             | UOM | VM1794A0 | 250X4.8 PA66 BLACK CLAMP | 2                                 | PZ | VM2103A0 | CLAMP LOCK | 2                              | PZ |    |          |                                      |   |    |          |                                |   |    |
|           |                                      |   | Code       | Description                      | Qty   | UOM  |             |                 |     |          |                          |                                   |    |          |            |                                |    |    |          |                                      |   |    |          |                                |   |    |
|           |                                      |   | VM1794A0   | 250X4.8 PA66 BLACK CLAMP         | 2   | PZ   |             |                 |     |          |                          |                                   |    |          |            |                                |    |    |          |                                      |   |    |          |                                |   |    |
| VM2103A0  | CLAMP LOCK                           | 2   | PZ         |                                  |   |      |             |                 |     |          |                          |                                   |    |          |            |                                |    |    |          |                                      |   |    |          |                                |   |    |
| KRS0090A  | HEATING ELEMENT 1.26KW               | <table border="1"> <thead> <tr> <th>Code</th> <th>Description</th> <th>Qty</th> <th>UOM</th> </tr> </thead> <tbody> <tr> <td>GN1326A1</td> <td>ELEMENT SEALING</td> <td>1</td> <td>PZ</td> </tr> <tr> <td>RS0090A0</td> <td>CIRC. HEAT. ELEMENT 1260W 220-230</td> <td>1</td> <td>PZ</td> </tr> <tr> <td>VI1220A1</td> <td>4,2X12 TCB SELF-TAPPIN G SCREW</td> <td>3</td> <td>PZ</td> </tr> <tr> <td>VM1794A0</td> <td>250X4.8 PA66 BLACK CLAMP</td> <td>2</td> <td>PZ</td> </tr> <tr> <td>VM2103A0</td> <td>CLAMP LOCK</td> <td>2</td> <td>PZ</td> </tr> </tbody> </table> | Code       | Description                      | Qty   | UOM  | GN1326A1    | ELEMENT SEALING | 1   | PZ       | RS0090A0                 | CIRC. HEAT. ELEMENT 1260W 220-230 | 1  | PZ       | VI1220A1   | 4,2X12 TCB SELF-TAPPIN G SCREW | 3  | PZ | VM1794A0 | 250X4.8 PA66 BLACK CLAMP             | 2 | PZ | VM2103A0 | CLAMP LOCK                     | 2 | PZ |
| Code      | Description                          | Qty   | UOM        |                                  |   |      |             |                 |     |          |                          |                                   |    |          |            |                                |    |    |          |                                      |   |    |          |                                |   |    |
| GN1326A1  | ELEMENT SEALING                      | 1   | PZ         |                                  |   |      |             |                 |     |          |                          |                                   |    |          |            |                                |    |    |          |                                      |   |    |          |                                |   |    |
| RS0090A0  | CIRC. HEAT. ELEMENT 1260W 220-230    | 1   | PZ         |                                  |   |      |             |                 |     |          |                          |                                   |    |          |            |                                |    |    |          |                                      |   |    |          |                                |   |    |
| VI1220A1  | 4,2X12 TCB SELF-TAPPIN G SCREW       | 3   | PZ         |                                  |   |      |             |                 |     |          |                          |                                   |    |          |            |                                |    |    |          |                                      |   |    |          |                                |   |    |
| VM1794A0  | 250X4.8 PA66 BLACK CLAMP             | 2   | PZ         |                                  |   |      |             |                 |     |          |                          |                                   |    |          |            |                                |    |    |          |                                      |   |    |          |                                |   |    |
| VM2103A0  | CLAMP LOCK                           | 2   | PZ         |                                  |   |      |             |                 |     |          |                          |                                   |    |          |            |                                |    |    |          |                                      |   |    |          |                                |   |    |
| KRS0050A  | HEATING ELEMENT KIT 0.5KW            | <table border="1"> <thead> <tr> <th>Code</th> <th>Description</th> <th>Qty</th> <th>UOM</th> </tr> </thead> <tbody> <tr> <td>GN1326A1</td> <td>ELEMENT SEALING</td> <td>1</td> <td>PZ</td> </tr> <tr> <td>IP1075A1</td> <td></td> <td>1</td> <td>PZ</td> </tr> <tr> <td>IP1080A1</td> <td></td> <td>1</td> <td>PZ</td> </tr> <tr> <td>RS0050A0</td> <td>HEAT. ELEMENT 500W 220-230V LIEV</td> <td>1</td> <td>PZ</td> </tr> <tr> <td>VI1220A1</td> <td>4,2X12 TCB SELF-TAPPIN G SCREW</td> <td>2</td> <td>PZ</td> </tr> </tbody> </table>                                    | Code       | Description                      | Qty   | UOM  | GN1326A1    | ELEMENT SEALING | 1   | PZ       | IP1075A1                 |                                   | 1  | PZ       | IP1080A1   |                                | 1  | PZ | RS0050A0 | HEAT. ELEMENT 500W 220-230V LIEV     | 1 | PZ | VI1220A1 | 4,2X12 TCB SELF-TAPPIN G SCREW | 2 | PZ |
| Code      | Description                          | Qty   | UOM        |                                  |   |      |             |                 |     |          |                          |                                   |    |          |            |                                |    |    |          |                                      |   |    |          |                                |   |    |
| GN1326A1  | ELEMENT SEALING                      | 1   | PZ         |                                  |   |      |             |                 |     |          |                          |                                   |    |          |            |                                |    |    |          |                                      |   |    |          |                                |   |    |
| IP1075A1  |                                      | 1   | PZ         |                                  |   |      |             |                 |     |          |                          |                                   |    |          |            |                                |    |    |          |                                      |   |    |          |                                |   |    |
| IP1080A1  |                                      | 1   | PZ         |                                  |   |      |             |                 |     |          |                          |                                   |    |          |            |                                |    |    |          |                                      |   |    |          |                                |   |    |
| RS0050A0  | HEAT. ELEMENT 500W 220-230V LIEV     | 1   | PZ         |                                  |   |      |             |                 |     |          |                          |                                   |    |          |            |                                |    |    |          |                                      |   |    |          |                                |   |    |
| VI1220A1  | 4,2X12 TCB SELF-TAPPIN G SCREW       | 2   | PZ         |                                  |   |      |             |                 |     |          |                          |                                   |    |          |            |                                |    |    |          |                                      |   |    |          |                                |   |    |
| KRS0011A  | HEATING ELEMENT 1.465KW RS0011A      | <table border="1"> <thead> <tr> <th>Code</th> <th>Description</th> <th>Qty</th> <th>UOM</th> </tr> </thead> <tbody> <tr> <td>GN1326A1</td> <td>ELEMENT SEALING</td> <td>1</td> <td>PZ</td> </tr> <tr> <td>RS0011A0</td> <td>CIRC.HEAT. ELEMENT 1465W 220-230</td> <td>1</td> <td>PZ</td> </tr> <tr> <td>VI1220A1</td> <td>4,2X12 TCB SELF-TAPPIN G SCREW</td> <td>3</td> <td>PZ</td> </tr> <tr> <td>VM1794A0</td> <td>250X4.8 PA66 BLACK CLAMP</td> <td>2</td> <td>PZ</td> </tr> <tr> <td>VM2103A0</td> <td>CLAMP LOCK</td> <td>2</td> <td>PZ</td> </tr> </tbody> </table>  | Code       | Description                      | Qty   | UOM  | GN1326A1    | ELEMENT SEALING | 1   | PZ       | RS0011A0                 | CIRC.HEAT. ELEMENT 1465W 220-230  | 1  | PZ       | VI1220A1   | 4,2X12 TCB SELF-TAPPIN G SCREW | 3  | PZ | VM1794A0 | 250X4.8 PA66 BLACK CLAMP             | 2 | PZ | VM2103A0 | CLAMP LOCK                     | 2 | PZ |
| Code      | Description                          | Qty   | UOM        |                                  |   |      |             |                 |     |          |                          |                                   |    |          |            |                                |    |    |          |                                      |   |    |          |                                |   |    |
| GN1326A1  | ELEMENT SEALING                      | 1   | PZ         |                                  |   |      |             |                 |     |          |                          |                                   |    |          |            |                                |    |    |          |                                      |   |    |          |                                |   |    |
| RS0011A0  | CIRC.HEAT. ELEMENT 1465W 220-230     | 1   | PZ         |                                  |   |      |             |                 |     |          |                          |                                   |    |          |            |                                |    |    |          |                                      |   |    |          |                                |   |    |
| VI1220A1  | 4,2X12 TCB SELF-TAPPIN G SCREW       | 3   | PZ         |                                  |   |      |             |                 |     |          |                          |                                   |    |          |            |                                |    |    |          |                                      |   |    |          |                                |   |    |
| VM1794A0  | 250X4.8 PA66 BLACK CLAMP             | 2   | PZ         |                                  |   |      |             |                 |     |          |                          |                                   |    |          |            |                                |    |    |          |                                      |   |    |          |                                |   |    |
| VM2103A0  | CLAMP LOCK                           | 2   | PZ         |                                  |   |      |             |                 |     |          |                          |                                   |    |          |            |                                |    |    |          |                                      |   |    |          |                                |   |    |
| KRS0010A  | KIT HEATING ELEMENT RS10010A         | <table border="1"> <thead> <tr> <th>Code</th> <th>Description</th> <th>Qty</th> <th>UOM</th> </tr> </thead> <tbody> <tr> <td>GN1326A1</td> <td>ELEMENT SEALING</td> <td>1</td> <td>PZ</td> </tr> <tr> <td>IP1075A1</td> <td></td> <td>1</td> <td>PZ</td> </tr> <tr> <td>IP1080A1</td> <td></td> <td>5</td> <td>PZ</td> </tr> <tr> <td>RS0010A0</td> <td>CIRC.HEAT. ELEMENT 2560W - 220-230 V</td> <td>1</td> <td>PZ</td> </tr> <tr> <td>VI1220A1</td> <td>4,2X12 TCB SELF-TAPPIN G SCREW</td> <td>3</td> <td>PZ</td> </tr> </tbody> </table>                                | Code       | Description                      | Qty   | UOM  | GN1326A1    | ELEMENT SEALING | 1   | PZ       | IP1075A1                 |                                   | 1  | PZ       | IP1080A1   |                                | 5  | PZ | RS0010A0 | CIRC.HEAT. ELEMENT 2560W - 220-230 V | 1 | PZ | VI1220A1 | 4,2X12 TCB SELF-TAPPIN G SCREW | 3 | PZ |
| Code      | Description                          | Qty   | UOM        |                                  |   |      |             |                 |     |          |                          |                                   |    |          |            |                                |    |    |          |                                      |   |    |          |                                |   |    |
| GN1326A1  | ELEMENT SEALING                      | 1   | PZ         |                                  |   |      |             |                 |     |          |                          |                                   |    |          |            |                                |    |    |          |                                      |   |    |          |                                |   |    |
| IP1075A1  |                                      | 1   | PZ         |                                  |   |      |             |                 |     |          |                          |                                   |    |          |            |                                |    |    |          |                                      |   |    |          |                                |   |    |
| IP1080A1  |                                      | 5   | PZ         |                                  |   |      |             |                 |     |          |                          |                                   |    |          |            |                                |    |    |          |                                      |   |    |          |                                |   |    |
| RS0010A0  | CIRC.HEAT. ELEMENT 2560W - 220-230 V | 1   | PZ         |                                  |   |      |             |                 |     |          |                          |                                   |    |          |            |                                |    |    |          |                                      |   |    |          |                                |   |    |
| VI1220A1  | 4,2X12 TCB SELF-TAPPIN G SCREW       | 3   | PZ         |                                  |   |      |             |                 |     |          |                          |                                   |    |          |            |                                |    |    |          |                                      |   |    |          |                                |   |    |



| COMPONENT |   |   | SPARE PART |                                  |   |      |             |     |     |          |                 |   |    |          |   |   |    |          |                                     |   |    |          |                                |   |    |          |                                     |   |    |
|-----------|---|---|------------|----------------------------------|---|------|-------------|-----|-----|----------|-----------------|---|----|----------|---|---|----|----------|-------------------------------------|---|----|----------|--------------------------------|---|----|----------|-------------------------------------|---|----|
| Code      | Description                             | Image   | Code       | Description                      | Components list   |      |             |     |     |          |                 |   |    |          |   |   |    |          |                                     |   |    |          |                                |   |    |          |                                     |   |    |
| GN1326A   | ELEMENT SEALING                         |  | KGN1326A   | HEATING ELEMENT GASKET 5 PCS KIT | <table border="1"> <thead> <tr> <th>Code</th> <th>Description</th> <th>Qty</th> <th>UOM</th> </tr> </thead> <tbody> <tr> <td>GN1326A1</td> <td>ELEMENT SEALING</td> <td>5</td> <td>PZ</td> </tr> </tbody> </table>  | Code | Description | Qty | UOM | GN1326A1 | ELEMENT SEALING | 5 | PZ |          |   |   |    |          |                                     |   |    |          |                                |   |    |          |                                     |   |    |
| Code      | Description                             | Qty   | UOM        |                                  |   |      |             |     |     |          |                 |   |    |          |   |   |    |          |                                     |   |    |          |                                |   |    |          |                                     |   |    |
| GN1326A1  | ELEMENT SEALING                         | 5   | PZ         |                                  |   |      |             |     |     |          |                 |   |    |          |   |   |    |          |                                     |   |    |          |                                |   |    |          |                                     |   |    |
| GN1326A   | ELEMENT SEALING                         |  | KRS1274A   | 100W MOTOR BRAKING ELEMENT KIT   | <table border="1"> <thead> <tr> <th>Code</th> <th>Description</th> <th>Qty</th> <th>UOM</th> </tr> </thead> <tbody> <tr> <td>GN1326A1</td> <td>ELEMENT SEALING</td> <td>1</td> <td>PZ</td> </tr> <tr> <td>RS1274A0</td> <td>100W 60V 1 TURN FLAT ELEMENT</td> <td>1</td> <td>PZ</td> </tr> <tr> <td>SL1045A0</td> <td>S53 BLACK SILICONE - 80ML CARTRIDGE</td> <td>1</td> <td>PZ</td> </tr> <tr> <td>VI1220A1</td> <td>4,2X12 TCB SELF-TAPPIN G SCREW</td> <td>2</td> <td>PZ</td> </tr> </tbody> </table>   | Code | Description | Qty | UOM | GN1326A1 | ELEMENT SEALING | 1 | PZ | RS1274A0 | 100W 60V 1 TURN FLAT ELEMENT            | 1 | PZ | SL1045A0 | S53 BLACK SILICONE - 80ML CARTRIDGE | 1 | PZ | VI1220A1 | 4,2X12 TCB SELF-TAPPIN G SCREW | 2 | PZ |          |                                     |   |    |
| Code      | Description                             | Qty   | UOM        |                                  |   |      |             |     |     |          |                 |   |    |          |   |   |    |          |                                     |   |    |          |                                |   |    |          |                                     |   |    |
| GN1326A1  | ELEMENT SEALING                         | 1   | PZ         |                                  |   |      |             |     |     |          |                 |   |    |          |   |   |    |          |                                     |   |    |          |                                |   |    |          |                                     |   |    |
| RS1274A0  | 100W 60V 1 TURN FLAT ELEMENT            | 1   | PZ         |                                  |   |      |             |     |     |          |                 |   |    |          |   |   |    |          |                                     |   |    |          |                                |   |    |          |                                     |   |    |
| SL1045A0  | S53 BLACK SILICONE - 80ML CARTRIDGE     | 1   | PZ         |                                  |   |      |             |     |     |          |                 |   |    |          |   |   |    |          |                                     |   |    |          |                                |   |    |          |                                     |   |    |
| VI1220A1  | 4,2X12 TCB SELF-TAPPIN G SCREW          | 2   | PZ         |                                  |   |      |             |     |     |          |                 |   |    |          |   |   |    |          |                                     |   |    |          |                                |   |    |          |                                     |   |    |
|           |   |   | KRS1261A   | 122W MOTOR BRAKING ELEMENT KIT   | <table border="1"> <thead> <tr> <th>Code</th> <th>Description</th> <th>Qty</th> <th>UOM</th> </tr> </thead> <tbody> <tr> <td>GN1326A1</td> <td>ELEMENT SEALING</td> <td>1</td> <td>PZ</td> </tr> <tr> <td>RS1261A0</td> <td>BAKERLUX/CH EFLUX MOTOR BRAKING ELEMENT</td> <td>1</td> <td>PZ</td> </tr> <tr> <td>SL1045A0</td> <td>S53 BLACK SILICONE - 80ML CARTRIDGE</td> <td>1</td> <td>PZ</td> </tr> <tr> <td>VI1220A1</td> <td>4,2X12 TCB SELF-TAPPIN G SCREW</td> <td>2</td> <td>PZ</td> </tr> <tr> <td>VM2147A0</td> <td>ESD SPONGE PINK SMOOTH 410X343X15 M</td> <td>1</td> <td>PZ</td> </tr> </tbody> </table> | Code | Description | Qty | UOM | GN1326A1 | ELEMENT SEALING | 1 | PZ | RS1261A0 | BAKERLUX/CH EFLUX MOTOR BRAKING ELEMENT | 1 | PZ | SL1045A0 | S53 BLACK SILICONE - 80ML CARTRIDGE | 1 | PZ | VI1220A1 | 4,2X12 TCB SELF-TAPPIN G SCREW | 2 | PZ | VM2147A0 | ESD SPONGE PINK SMOOTH 410X343X15 M | 1 | PZ |
| Code      | Description                             | Qty   | UOM        |                                  |   |      |             |     |     |          |                 |   |    |          |   |   |    |          |                                     |   |    |          |                                |   |    |          |                                     |   |    |
| GN1326A1  | ELEMENT SEALING                         | 1   | PZ         |                                  |   |      |             |     |     |          |                 |   |    |          |   |   |    |          |                                     |   |    |          |                                |   |    |          |                                     |   |    |
| RS1261A0  | BAKERLUX/CH EFLUX MOTOR BRAKING ELEMENT | 1   | PZ         |                                  |   |      |             |     |     |          |                 |   |    |          |   |   |    |          |                                     |   |    |          |                                |   |    |          |                                     |   |    |
| SL1045A0  | S53 BLACK SILICONE - 80ML CARTRIDGE     | 1   | PZ         |                                  |   |      |             |     |     |          |                 |   |    |          |   |   |    |          |                                     |   |    |          |                                |   |    |          |                                     |   |    |
| VI1220A1  | 4,2X12 TCB SELF-TAPPIN G SCREW          | 2   | PZ         |                                  |   |      |             |     |     |          |                 |   |    |          |   |   |    |          |                                     |   |    |          |                                |   |    |          |                                     |   |    |
| VM2147A0  | ESD SPONGE PINK SMOOTH 410X343X15 M     | 1   | PZ         |                                  |   |      |             |     |     |          |                 |   |    |          |   |   |    |          |                                     |   |    |          |                                |   |    |          |                                     |   |    |
|           |   |   | KRS1215A   | 147W MOTOR BRAKING ELEMENT KIT   | <table border="1"> <thead> <tr> <th>Code</th> <th>Description</th> <th>Qty</th> <th>UOM</th> </tr> </thead> <tbody> <tr> <td>GN1326A1</td> <td>ELEMENT SEALING</td> <td>1</td> <td>PZ</td> </tr> <tr> <td>RS1215A1</td> <td>147W 105V BRAKING ELEMENT</td> <td>1</td> <td>PZ</td> </tr> <tr> <td>SL1045A0</td> <td>S53 BLACK SILICONE - 80ML CARTRIDGE</td> <td>1</td> <td>PZ</td> </tr> <tr> <td>VI1220A1</td> <td>4,2X12 TCB SELF-TAPPIN G SCREW</td> <td>2</td> <td>PZ</td> </tr> </tbody> </table>  | Code | Description | Qty | UOM | GN1326A1 | ELEMENT SEALING | 1 | PZ | RS1215A1 | 147W 105V BRAKING ELEMENT               | 1 | PZ | SL1045A0 | S53 BLACK SILICONE - 80ML CARTRIDGE | 1 | PZ | VI1220A1 | 4,2X12 TCB SELF-TAPPIN G SCREW | 2 | PZ |          |                                     |   |    |
| Code      | Description                             | Qty   | UOM        |                                  |   |      |             |     |     |          |                 |   |    |          |   |   |    |          |                                     |   |    |          |                                |   |    |          |                                     |   |    |
| GN1326A1  | ELEMENT SEALING                         | 1   | PZ         |                                  |   |      |             |     |     |          |                 |   |    |          |   |   |    |          |                                     |   |    |          |                                |   |    |          |                                     |   |    |
| RS1215A1  | 147W 105V BRAKING ELEMENT               | 1   | PZ         |                                  |   |      |             |     |     |          |                 |   |    |          |   |   |    |          |                                     |   |    |          |                                |   |    |          |                                     |   |    |
| SL1045A0  | S53 BLACK SILICONE - 80ML CARTRIDGE     | 1   | PZ         |                                  |   |      |             |     |     |          |                 |   |    |          |   |   |    |          |                                     |   |    |          |                                |   |    |          |                                     |   |    |
| VI1220A1  | 4,2X12 TCB SELF-TAPPIN G SCREW          | 2   | PZ         |                                  |   |      |             |     |     |          |                 |   |    |          |   |   |    |          |                                     |   |    |          |                                |   |    |          |                                     |   |    |



| COMPONENT |  |   | SPARE PART |                           |   |      |             |                 |     |          |                 |                                     |    |          |  |                                     |   |          |                            |                               |    |          |                                     |                          |    |          |                               |            |    |          |                       |       |   |
|-----------|--|---|------------|---------------------------|---|------|-------------|-----------------|-----|----------|-----------------|-------------------------------------|----|----------|--|-------------------------------------|---|----------|----------------------------|-------------------------------|----|----------|-------------------------------------|--------------------------|----|----------|-------------------------------|------------|----|----------|-----------------------|-------|---|
| Code      | Description                            | Image   | Code       | Description               | Components list   |      |             |                 |     |          |                 |                                     |    |          |  |                                     |   |          |                            |                               |    |          |                                     |                          |    |          |                               |            |    |          |                       |       |   |
| GN1326A   | ELEMENT SEALING                        |    | KRS1095A   | 1.2KW HEATING ELEMENT KIT | <table border="1"> <thead> <tr> <th>Code</th> <th>Description</th> <th>Qty</th> <th>UOM</th> </tr> </thead> <tbody> <tr> <td>GN1326A1</td> <td>ELEMENT SEALING</td> <td>1</td> <td>PZ</td> </tr> <tr> <td>IP1385A1</td> <td>CORNER POLYSTYRENE PACKING 110X80X2000</td> <td>0.500</td> <td>M</td> </tr> <tr> <td>RS1095A1</td> <td>HEATING ELEMENT 1200W 230V</td> <td>1</td> <td>PZ</td> </tr> <tr> <td>SL1045A0</td> <td>S53 BLACK SILICONE - 80ML CARTRIDGE</td> <td>1</td> <td>PZ</td> </tr> <tr> <td>VI1220A1</td> <td>4,2X12 TCB SELF-TAPPING SCREW</td> <td>2</td> <td>PZ</td> </tr> <tr> <td>VM1059A1</td> <td>HEAT SHRINK FILM H800</td> <td>1.200</td> <td>M</td> </tr> </tbody> </table> | Code | Description | Qty             | UOM | GN1326A1 | ELEMENT SEALING | 1                                   | PZ | IP1385A1 | CORNER POLYSTYRENE PACKING 110X80X2000 | 0.500                               | M | RS1095A1 | HEATING ELEMENT 1200W 230V | 1                             | PZ | SL1045A0 | S53 BLACK SILICONE - 80ML CARTRIDGE | 1                        | PZ | VI1220A1 | 4,2X12 TCB SELF-TAPPING SCREW | 2          | PZ | VM1059A1 | HEAT SHRINK FILM H800 | 1.200 | M |
|           |  |   | Code       | Description               | Qty   | UOM  |             |                 |     |          |                 |                                     |    |          |  |                                     |   |          |                            |                               |    |          |                                     |                          |    |          |                               |            |    |          |                       |       |   |
|           |  |   | GN1326A1   | ELEMENT SEALING           | 1   | PZ   |             |                 |     |          |                 |                                     |    |          |  |                                     |   |          |                            |                               |    |          |                                     |                          |    |          |                               |            |    |          |                       |       |   |
| IP1385A1  | CORNER POLYSTYRENE PACKING 110X80X2000 | 0.500   | M          |                           |   |      |             |                 |     |          |                 |                                     |    |          |  |                                     |   |          |                            |                               |    |          |                                     |                          |    |          |                               |            |    |          |                       |       |   |
| RS1095A1  | HEATING ELEMENT 1200W 230V             | 1   | PZ         |                           |   |      |             |                 |     |          |                 |                                     |    |          |  |                                     |   |          |                            |                               |    |          |                                     |                          |    |          |                               |            |    |          |                       |       |   |
| SL1045A0  | S53 BLACK SILICONE - 80ML CARTRIDGE    | 1   | PZ         |                           |   |      |             |                 |     |          |                 |                                     |    |          |  |                                     |   |          |                            |                               |    |          |                                     |                          |    |          |                               |            |    |          |                       |       |   |
| VI1220A1  | 4,2X12 TCB SELF-TAPPING SCREW          | 2   | PZ         |                           |   |      |             |                 |     |          |                 |                                     |    |          |  |                                     |   |          |                            |                               |    |          |                                     |                          |    |          |                               |            |    |          |                       |       |   |
| VM1059A1  | HEAT SHRINK FILM H800                  | 1.200   | M          |                           |   |      |             |                 |     |          |                 |                                     |    |          |  |                                     |   |          |                            |                               |    |          |                                     |                          |    |          |                               |            |    |          |                       |       |   |
| KRS1012A  | 1365W 120V HEATING ELEMENT KIT         | <table border="1"> <thead> <tr> <th>Code</th> <th>Description</th> <th>Qty</th> <th>UOM</th> </tr> </thead> <tbody> <tr> <td>GN1326A1</td> <td>ELEMENT SEALING</td> <td>1</td> <td>PZ</td> </tr> <tr> <td>RS1012A0</td> <td>CIRCULAR HEATING ELEMENT 1365W 120V</td> <td>1</td> <td>PZ</td> </tr> <tr> <td>VI1220A1</td> <td>4,2X12 TCB SELF-TAPPING SCREW</td> <td>5</td> <td>PZ</td> </tr> <tr> <td>VM1794A0</td> <td>250X4.8 PA66 BLACK CLAMP</td> <td>2</td> <td>PZ</td> </tr> <tr> <td>VM2103A0</td> <td>CLAMP LOCK</td> <td>2</td> <td>PZ</td> </tr> </tbody> </table>  | Code       | Description               | Qty   | UOM  | GN1326A1    | ELEMENT SEALING | 1   | PZ       | RS1012A0        | CIRCULAR HEATING ELEMENT 1365W 120V | 1  | PZ       | VI1220A1                               | 4,2X12 TCB SELF-TAPPING SCREW       | 5 | PZ       | VM1794A0                   | 250X4.8 PA66 BLACK CLAMP      | 2  | PZ       | VM2103A0                            | CLAMP LOCK               | 2  | PZ       |                               |            |    |          |                       |       |   |
| Code      | Description                            | Qty   | UOM        |                           |   |      |             |                 |     |          |                 |                                     |    |          |  |                                     |   |          |                            |                               |    |          |                                     |                          |    |          |                               |            |    |          |                       |       |   |
| GN1326A1  | ELEMENT SEALING                        | 1   | PZ         |                           |   |      |             |                 |     |          |                 |                                     |    |          |  |                                     |   |          |                            |                               |    |          |                                     |                          |    |          |                               |            |    |          |                       |       |   |
| RS1012A0  | CIRCULAR HEATING ELEMENT 1365W 120V    | 1   | PZ         |                           |   |      |             |                 |     |          |                 |                                     |    |          |  |                                     |   |          |                            |                               |    |          |                                     |                          |    |          |                               |            |    |          |                       |       |   |
| VI1220A1  | 4,2X12 TCB SELF-TAPPING SCREW          | 5   | PZ         |                           |   |      |             |                 |     |          |                 |                                     |    |          |  |                                     |   |          |                            |                               |    |          |                                     |                          |    |          |                               |            |    |          |                       |       |   |
| VM1794A0  | 250X4.8 PA66 BLACK CLAMP               | 2   | PZ         |                           |   |      |             |                 |     |          |                 |                                     |    |          |  |                                     |   |          |                            |                               |    |          |                                     |                          |    |          |                               |            |    |          |                       |       |   |
| VM2103A0  | CLAMP LOCK                             | 2   | PZ         |                           |   |      |             |                 |     |          |                 |                                     |    |          |  |                                     |   |          |                            |                               |    |          |                                     |                          |    |          |                               |            |    |          |                       |       |   |
| KRS1011A  | ROBERTA/LISA HEATING ELEMENT KIT       | <table border="1"> <thead> <tr> <th>Code</th> <th>Description</th> <th>Qty</th> <th>UOM</th> </tr> </thead> <tbody> <tr> <td>GN1326A1</td> <td>ELEMENT SEALING</td> <td>1</td> <td>PZ</td> </tr> <tr> <td>RS1011A0</td> <td>2560W HEATING ELEMENT</td> <td>1</td> <td>PZ</td> </tr> <tr> <td>SL1045A0</td> <td>S53 BLACK SILICONE - 80ML CARTRIDGE</td> <td>1</td> <td>PZ</td> </tr> <tr> <td>VI1220A1</td> <td>4,2X12 TCB SELF-TAPPING SCREW</td> <td>5</td> <td>PZ</td> </tr> <tr> <td>VM1794A0</td> <td>250X4.8 PA66 BLACK CLAMP</td> <td>2</td> <td>PZ</td> </tr> <tr> <td>VM2103A0</td> <td>CLAMP LOCK</td> <td>2</td> <td>PZ</td> </tr> </tbody> </table> | Code       | Description               | Qty   | UOM  | GN1326A1    | ELEMENT SEALING | 1   | PZ       | RS1011A0        | 2560W HEATING ELEMENT               | 1  | PZ       | SL1045A0                               | S53 BLACK SILICONE - 80ML CARTRIDGE | 1 | PZ       | VI1220A1                   | 4,2X12 TCB SELF-TAPPING SCREW | 5  | PZ       | VM1794A0                            | 250X4.8 PA66 BLACK CLAMP | 2  | PZ       | VM2103A0                      | CLAMP LOCK | 2  | PZ       |                       |       |   |
| Code      | Description                            | Qty   | UOM        |                           |   |      |             |                 |     |          |                 |                                     |    |          |  |                                     |   |          |                            |                               |    |          |                                     |                          |    |          |                               |            |    |          |                       |       |   |
| GN1326A1  | ELEMENT SEALING                        | 1   | PZ         |                           |   |      |             |                 |     |          |                 |                                     |    |          |  |                                     |   |          |                            |                               |    |          |                                     |                          |    |          |                               |            |    |          |                       |       |   |
| RS1011A0  | 2560W HEATING ELEMENT                  | 1   | PZ         |                           |   |      |             |                 |     |          |                 |                                     |    |          |  |                                     |   |          |                            |                               |    |          |                                     |                          |    |          |                               |            |    |          |                       |       |   |
| SL1045A0  | S53 BLACK SILICONE - 80ML CARTRIDGE    | 1   | PZ         |                           |   |      |             |                 |     |          |                 |                                     |    |          |  |                                     |   |          |                            |                               |    |          |                                     |                          |    |          |                               |            |    |          |                       |       |   |
| VI1220A1  | 4,2X12 TCB SELF-TAPPING SCREW          | 5   | PZ         |                           |   |      |             |                 |     |          |                 |                                     |    |          |  |                                     |   |          |                            |                               |    |          |                                     |                          |    |          |                               |            |    |          |                       |       |   |
| VM1794A0  | 250X4.8 PA66 BLACK CLAMP               | 2   | PZ         |                           |   |      |             |                 |     |          |                 |                                     |    |          |  |                                     |   |          |                            |                               |    |          |                                     |                          |    |          |                               |            |    |          |                       |       |   |
| VM2103A0  | CLAMP LOCK                             | 2   | PZ         |                           |   |      |             |                 |     |          |                 |                                     |    |          |  |                                     |   |          |                            |                               |    |          |                                     |                          |    |          |                               |            |    |          |                       |       |   |
| KRS0090A  | HEATING ELEMENT 1.26KW                 | <table border="1"> <thead> <tr> <th>Code</th> <th>Description</th> <th>Qty</th> <th>UOM</th> </tr> </thead> <tbody> <tr> <td>GN1326A1</td> <td>ELEMENT SEALING</td> <td>1</td> <td>PZ</td> </tr> </tbody> </table>  | Code       | Description               | Qty   | UOM  | GN1326A1    | ELEMENT SEALING | 1   | PZ       |                 |                                     |    |          |  |                                     |   |          |                            |                               |    |          |                                     |                          |    |          |                               |            |    |          |                       |       |   |
| Code      | Description                            | Qty   | UOM        |                           |   |      |             |                 |     |          |                 |                                     |    |          |  |                                     |   |          |                            |                               |    |          |                                     |                          |    |          |                               |            |    |          |                       |       |   |
| GN1326A1  | ELEMENT SEALING                        | 1   | PZ         |                           |   |      |             |                 |     |          |                 |                                     |    |          |  |                                     |   |          |                            |                               |    |          |                                     |                          |    |          |                               |            |    |          |                       |       |   |

| COMPONENT |  |  | SPARE PART |                                      |  |      |             |                 |     |          |                                      |                                     |    |          |                                |                                |    |          |                          |  |    |          |            |                                |    |    |
|-----------|--|--|------------|--------------------------------------|--|------|-------------|-----------------|-----|----------|--------------------------------------|-------------------------------------|----|----------|--------------------------------|--------------------------------|----|----------|--------------------------|--|----|----------|------------|--------------------------------|----|----|
| Code      | Description                                | Image  | Code       | Description                          | Components list  |      |             |                 |     |          |                                      |                                     |    |          |                                |                                |    |          |                          |  |    |          |            |                                |    |    |
| GN1326A   | ELEMENT SEALING                            |   | KRS0090A   | HEATING ELEMENT<br>1.26KW            | <table border="1"> <thead> <tr> <th>Code</th> <th>Description</th> <th>Qty</th> <th>UOM</th> </tr> </thead> <tbody> <tr> <td>RS0090A0</td> <td>CIRC. HEAT. ELEMENT<br/>1260W 220-230</td> <td>1</td> <td>PZ</td> </tr> <tr> <td>VI1220A1</td> <td>4,2X12 TCB SELF-TAPPIN G SCREW</td> <td>3</td> <td>PZ</td> </tr> <tr> <td>VM1794A0</td> <td>250X4.8 PA66 BLACK CLAMP</td> <td>2</td> <td>PZ</td> </tr> <tr> <td>VM2103A0</td> <td>CLAMP LOCK</td> <td>2</td> <td>PZ</td> </tr> </tbody> </table> | Code | Description | Qty             | UOM | RS0090A0 | CIRC. HEAT. ELEMENT<br>1260W 220-230 | 1                                   | PZ | VI1220A1 | 4,2X12 TCB SELF-TAPPIN G SCREW | 3                              | PZ | VM1794A0 | 250X4.8 PA66 BLACK CLAMP | 2  | PZ | VM2103A0 | CLAMP LOCK | 2                              | PZ |    |
|           |  |  | Code       | Description                          | Qty  | UOM  |             |                 |     |          |                                      |                                     |    |          |                                |                                |    |          |                          |  |    |          |            |                                |    |    |
|           |  |  | RS0090A0   | CIRC. HEAT. ELEMENT<br>1260W 220-230 | 1  | PZ   |             |                 |     |          |                                      |                                     |    |          |                                |                                |    |          |                          |  |    |          |            |                                |    |    |
|           |  |  | VI1220A1   | 4,2X12 TCB SELF-TAPPIN G SCREW       | 3  | PZ   |             |                 |     |          |                                      |                                     |    |          |                                |                                |    |          |                          |  |    |          |            |                                |    |    |
| VM1794A0  | 250X4.8 PA66 BLACK CLAMP                   | 2  | PZ         |                                      |  |      |             |                 |     |          |                                      |                                     |    |          |                                |                                |    |          |                          |  |    |          |            |                                |    |    |
| VM2103A0  | CLAMP LOCK                                 | 2  | PZ         |                                      |  |      |             |                 |     |          |                                      |                                     |    |          |                                |                                |    |          |                          |  |    |          |            |                                |    |    |
| KRS0050A  | HEATING ELEMENT<br>KIT 0.5KW               | <table border="1"> <thead> <tr> <th>Code</th> <th>Description</th> <th>Qty</th> <th>UOM</th> </tr> </thead> <tbody> <tr> <td>GN1326A1</td> <td>ELEMENT SEALING</td> <td>1</td> <td>PZ</td> </tr> <tr> <td>IP1075A1</td> <td></td> <td>1</td> <td>PZ</td> </tr> <tr> <td>IP1080A1</td> <td></td> <td>1</td> <td>PZ</td> </tr> <tr> <td>RS0050A0</td> <td>HEAT. ELEMENT<br/>500W<br/>220-230V LIEV</td> <td>1</td> <td>PZ</td> </tr> <tr> <td>VI1220A1</td> <td>4,2X12 TCB SELF-TAPPIN G SCREW</td> <td>2</td> <td>PZ</td> </tr> </tbody> </table>                               | Code       | Description                          | Qty  | UOM  | GN1326A1    | ELEMENT SEALING | 1   | PZ       | IP1075A1                             |                                     | 1  | PZ       | IP1080A1                       |                                | 1  | PZ       | RS0050A0                 | HEAT. ELEMENT<br>500W<br>220-230V LIEV     | 1  | PZ       | VI1220A1   | 4,2X12 TCB SELF-TAPPIN G SCREW | 2  | PZ |
| Code      | Description                                | Qty  | UOM        |                                      |  |      |             |                 |     |          |                                      |                                     |    |          |                                |                                |    |          |                          |  |    |          |            |                                |    |    |
| GN1326A1  | ELEMENT SEALING                            | 1  | PZ         |                                      |  |      |             |                 |     |          |                                      |                                     |    |          |                                |                                |    |          |                          |  |    |          |            |                                |    |    |
| IP1075A1  |  | 1  | PZ         |                                      |  |      |             |                 |     |          |                                      |                                     |    |          |                                |                                |    |          |                          |  |    |          |            |                                |    |    |
| IP1080A1  |  | 1  | PZ         |                                      |  |      |             |                 |     |          |                                      |                                     |    |          |                                |                                |    |          |                          |  |    |          |            |                                |    |    |
| RS0050A0  | HEAT. ELEMENT<br>500W<br>220-230V LIEV     | 1  | PZ         |                                      |  |      |             |                 |     |          |                                      |                                     |    |          |                                |                                |    |          |                          |  |    |          |            |                                |    |    |
| VI1220A1  | 4,2X12 TCB SELF-TAPPIN G SCREW             | 2  | PZ         |                                      |  |      |             |                 |     |          |                                      |                                     |    |          |                                |                                |    |          |                          |  |    |          |            |                                |    |    |
| KRS0011A  | HEATING ELEMENT<br>1.465KW RS0011A         | <table border="1"> <thead> <tr> <th>Code</th> <th>Description</th> <th>Qty</th> <th>UOM</th> </tr> </thead> <tbody> <tr> <td>GN1326A1</td> <td>ELEMENT SEALING</td> <td>1</td> <td>PZ</td> </tr> <tr> <td>RS0011A0</td> <td>CIRC.HEAT. ELEMENT<br/>1465W 220-230</td> <td>1</td> <td>PZ</td> </tr> <tr> <td>VI1220A1</td> <td>4,2X12 TCB SELF-TAPPIN G SCREW</td> <td>3</td> <td>PZ</td> </tr> <tr> <td>VM1794A0</td> <td>250X4.8 PA66 BLACK CLAMP</td> <td>2</td> <td>PZ</td> </tr> <tr> <td>VM2103A0</td> <td>CLAMP LOCK</td> <td>2</td> <td>PZ</td> </tr> </tbody> </table> | Code       | Description                          | Qty  | UOM  | GN1326A1    | ELEMENT SEALING | 1   | PZ       | RS0011A0                             | CIRC.HEAT. ELEMENT<br>1465W 220-230 | 1  | PZ       | VI1220A1                       | 4,2X12 TCB SELF-TAPPIN G SCREW | 3  | PZ       | VM1794A0                 | 250X4.8 PA66 BLACK CLAMP                   | 2  | PZ       | VM2103A0   | CLAMP LOCK                     | 2  | PZ |
| Code      | Description                                | Qty  | UOM        |                                      |  |      |             |                 |     |          |                                      |                                     |    |          |                                |                                |    |          |                          |  |    |          |            |                                |    |    |
| GN1326A1  | ELEMENT SEALING                            | 1  | PZ         |                                      |  |      |             |                 |     |          |                                      |                                     |    |          |                                |                                |    |          |                          |  |    |          |            |                                |    |    |
| RS0011A0  | CIRC.HEAT. ELEMENT<br>1465W 220-230        | 1  | PZ         |                                      |  |      |             |                 |     |          |                                      |                                     |    |          |                                |                                |    |          |                          |  |    |          |            |                                |    |    |
| VI1220A1  | 4,2X12 TCB SELF-TAPPIN G SCREW             | 3  | PZ         |                                      |  |      |             |                 |     |          |                                      |                                     |    |          |                                |                                |    |          |                          |  |    |          |            |                                |    |    |
| VM1794A0  | 250X4.8 PA66 BLACK CLAMP                   | 2  | PZ         |                                      |  |      |             |                 |     |          |                                      |                                     |    |          |                                |                                |    |          |                          |  |    |          |            |                                |    |    |
| VM2103A0  | CLAMP LOCK                                 | 2  | PZ         |                                      |  |      |             |                 |     |          |                                      |                                     |    |          |                                |                                |    |          |                          |  |    |          |            |                                |    |    |
| KRS0010A  | KIT HEATING<br>ELEMENT RS10010A            | <table border="1"> <thead> <tr> <th>Code</th> <th>Description</th> <th>Qty</th> <th>UOM</th> </tr> </thead> <tbody> <tr> <td>GN1326A1</td> <td>ELEMENT SEALING</td> <td>1</td> <td>PZ</td> </tr> <tr> <td>IP1075A1</td> <td></td> <td>1</td> <td>PZ</td> </tr> <tr> <td>IP1080A1</td> <td></td> <td>5</td> <td>PZ</td> </tr> <tr> <td>RS0010A0</td> <td>CIRC.HEAT. ELEMENT<br/>2560W -<br/>220-230 V</td> <td>1</td> <td>PZ</td> </tr> <tr> <td>VI1220A1</td> <td>4,2X12 TCB SELF-TAPPIN G SCREW</td> <td>3</td> <td>PZ</td> </tr> </tbody> </table>                           | Code       | Description                          | Qty  | UOM  | GN1326A1    | ELEMENT SEALING | 1   | PZ       | IP1075A1                             |                                     | 1  | PZ       | IP1080A1                       |                                | 5  | PZ       | RS0010A0                 | CIRC.HEAT. ELEMENT<br>2560W -<br>220-230 V | 1  | PZ       | VI1220A1   | 4,2X12 TCB SELF-TAPPIN G SCREW | 3  | PZ |
| Code      | Description                                | Qty  | UOM        |                                      |  |      |             |                 |     |          |                                      |                                     |    |          |                                |                                |    |          |                          |  |    |          |            |                                |    |    |
| GN1326A1  | ELEMENT SEALING                            | 1  | PZ         |                                      |  |      |             |                 |     |          |                                      |                                     |    |          |                                |                                |    |          |                          |  |    |          |            |                                |    |    |
| IP1075A1  |  | 1  | PZ         |                                      |  |      |             |                 |     |          |                                      |                                     |    |          |                                |                                |    |          |                          |  |    |          |            |                                |    |    |
| IP1080A1  |  | 5  | PZ         |                                      |  |      |             |                 |     |          |                                      |                                     |    |          |                                |                                |    |          |                          |  |    |          |            |                                |    |    |
| RS0010A0  | CIRC.HEAT. ELEMENT<br>2560W -<br>220-230 V | 1  | PZ         |                                      |  |      |             |                 |     |          |                                      |                                     |    |          |                                |                                |    |          |                          |  |    |          |            |                                |    |    |
| VI1220A1  | 4,2X12 TCB SELF-TAPPIN G SCREW             | 3  | PZ         |                                      |  |      |             |                 |     |          |                                      |                                     |    |          |                                |                                |    |          |                          |  |    |          |            |                                |    |    |
| KGN1326A  | HEATING ELEMENT<br>GASKET 5 PCS KIT        | <table border="1"> <thead> <tr> <th>Code</th> <th>Description</th> <th>Qty</th> <th>UOM</th> </tr> </thead> <tbody> <tr> <td>GN1326A1</td> <td>ELEMENT SEALING</td> <td>5</td> <td>PZ</td> </tr> </tbody> </table>   | Code       | Description                          | Qty  | UOM  | GN1326A1    | ELEMENT SEALING | 5   | PZ       |                                      |                                     |    |          |                                |                                |    |          |                          |  |    |          |            |                                |    |    |
| Code      | Description                                | Qty  | UOM        |                                      |  |      |             |                 |     |          |                                      |                                     |    |          |                                |                                |    |          |                          |  |    |          |            |                                |    |    |
| GN1326A1  | ELEMENT SEALING                            | 5  | PZ         |                                      |  |      |             |                 |     |          |                                      |                                     |    |          |                                |                                |    |          |                          |  |    |          |            |                                |    |    |



| COMPONENT |  |  | SPARE PART |   |   |      |             |     |     |          |   |   |    |          |  |   |    |          |  |   |    |          |                                      |   |    |          |   |   |    |
|-----------|--|--|------------|---|---|------|-------------|-----|-----|----------|---|---|----|----------|--|---|----|----------|--|---|----|----------|--------------------------------------|---|----|----------|---|---|----|
| Code      | Description                                  | Image  | Code       | Description                                 | Components list   |      |             |     |     |          |   |   |    |          |  |   |    |          |  |   |    |          |                                      |   |    |          |   |   |    |
| RS1274A   | 100W 60V 1 TURN<br>FLAT ELEMENT              |   | KRS1274A   | 100W MOTOR<br>BRAKING ELEMENT<br>KIT        | <table border="1"> <thead> <tr> <th>Code</th> <th>Description</th> <th>Qty</th> <th>UOM</th> </tr> </thead> <tbody> <tr> <td>GN1326A1</td> <td>ELEMENT<br/>SEALING</td> <td>1</td> <td>PZ</td> </tr> <tr> <td>RS1274A0</td> <td>100W 60V 1<br/>TURN FLAT<br/>ELEMENT</td> <td>1</td> <td>PZ</td> </tr> <tr> <td>SL1045A0</td> <td>S53 BLACK<br/>SILICONE -<br/>80ML<br/>CARTRIDGE</td> <td>1</td> <td>PZ</td> </tr> <tr> <td>VI1220A1</td> <td>4,2X12 TCB<br/>SELF-TAPPIN<br/>G SCREW</td> <td>2</td> <td>PZ</td> </tr> </tbody> </table>   | Code | Description | Qty | UOM | GN1326A1 | ELEMENT<br>SEALING                      | 1 | PZ | RS1274A0 | 100W 60V 1<br>TURN FLAT<br>ELEMENT           | 1 | PZ | SL1045A0 | S53 BLACK<br>SILICONE -<br>80ML<br>CARTRIDGE | 1 | PZ | VI1220A1 | 4,2X12 TCB<br>SELF-TAPPIN<br>G SCREW | 2 | PZ |          |   |   |    |
| Code      | Description                                  | Qty  | UOM        |   |   |      |             |     |     |          |   |   |    |          |  |   |    |          |  |   |    |          |                                      |   |    |          |   |   |    |
| GN1326A1  | ELEMENT<br>SEALING                           | 1  | PZ         |   |   |      |             |     |     |          |   |   |    |          |  |   |    |          |  |   |    |          |                                      |   |    |          |   |   |    |
| RS1274A0  | 100W 60V 1<br>TURN FLAT<br>ELEMENT           | 1  | PZ         |   |   |      |             |     |     |          |   |   |    |          |  |   |    |          |  |   |    |          |                                      |   |    |          |   |   |    |
| SL1045A0  | S53 BLACK<br>SILICONE -<br>80ML<br>CARTRIDGE | 1  | PZ         |   |   |      |             |     |     |          |   |   |    |          |  |   |    |          |  |   |    |          |                                      |   |    |          |   |   |    |
| VI1220A1  | 4,2X12 TCB<br>SELF-TAPPIN<br>G SCREW         | 2  | PZ         |   |   |      |             |     |     |          |   |   |    |          |  |   |    |          |  |   |    |          |                                      |   |    |          |   |   |    |
| GN1285A   | NTC TEMPERATURE<br>PROBE SEALING             |  | KTR1106A   | 5-5E S. L2000<br>CHAMBER TEMP.<br>PROBE KIT | <table border="1"> <thead> <tr> <th>Code</th> <th>Description</th> <th>Qty</th> <th>UOM</th> </tr> </thead> <tbody> <tr> <td>GN1285A0</td> <td>NTC<br/>TEMPERATUR<br/>E PROBE<br/>SEALING</td> <td>1</td> <td>PZ</td> </tr> <tr> <td>SL1045A0</td> <td>S53 BLACK<br/>SILICONE -<br/>80ML<br/>CARTRIDGE</td> <td>1</td> <td>PZ</td> </tr> <tr> <td>TR1106A3</td> <td>PT100 L=2000<br/>TEMPERATUR<br/>E PROBE</td> <td>1</td> <td>PZ</td> </tr> <tr> <td>VI1220A1</td> <td>4,2X12 TCB<br/>SELF-TAPPIN<br/>G SCREW</td> <td>2</td> <td>PZ</td> </tr> <tr> <td>VM1465A0</td> <td>CHEFTOP<br/>TEMPERATUR<br/>E PROBE<br/>COVER</td> <td>1</td> <td>PZ</td> </tr> </tbody> </table> | Code | Description | Qty | UOM | GN1285A0 | NTC<br>TEMPERATUR<br>E PROBE<br>SEALING | 1 | PZ | SL1045A0 | S53 BLACK<br>SILICONE -<br>80ML<br>CARTRIDGE | 1 | PZ | TR1106A3 | PT100 L=2000<br>TEMPERATUR<br>E PROBE        | 1 | PZ | VI1220A1 | 4,2X12 TCB<br>SELF-TAPPIN<br>G SCREW | 2 | PZ | VM1465A0 | CHEFTOP<br>TEMPERATUR<br>E PROBE<br>COVER | 1 | PZ |
| Code      | Description                                  | Qty  | UOM        |   |   |      |             |     |     |          |   |   |    |          |  |   |    |          |  |   |    |          |                                      |   |    |          |   |   |    |
| GN1285A0  | NTC<br>TEMPERATUR<br>E PROBE<br>SEALING      | 1  | PZ         |   |   |      |             |     |     |          |   |   |    |          |  |   |    |          |  |   |    |          |                                      |   |    |          |   |   |    |
| SL1045A0  | S53 BLACK<br>SILICONE -<br>80ML<br>CARTRIDGE | 1  | PZ         |   |   |      |             |     |     |          |   |   |    |          |  |   |    |          |  |   |    |          |                                      |   |    |          |   |   |    |
| TR1106A3  | PT100 L=2000<br>TEMPERATUR<br>E PROBE        | 1  | PZ         |   |   |      |             |     |     |          |   |   |    |          |  |   |    |          |  |   |    |          |                                      |   |    |          |   |   |    |
| VI1220A1  | 4,2X12 TCB<br>SELF-TAPPIN<br>G SCREW         | 2  | PZ         |   |   |      |             |     |     |          |   |   |    |          |  |   |    |          |  |   |    |          |                                      |   |    |          |   |   |    |
| VM1465A0  | CHEFTOP<br>TEMPERATUR<br>E PROBE<br>COVER    | 1  | PZ         |   |   |      |             |     |     |          |   |   |    |          |  |   |    |          |  |   |    |          |                                      |   |    |          |   |   |    |
|           |  |  | KTR1105A   | PT100 L1000<br>TEMPERATURE<br>PROBE KIT     | <table border="1"> <thead> <tr> <th>Code</th> <th>Description</th> <th>Qty</th> <th>UOM</th> </tr> </thead> <tbody> <tr> <td>GN1120A0</td> <td>TEMPERATUR<br/>E PROBE NTC<br/>SEAL</td> <td>1</td> <td>PZ</td> </tr> <tr> <td>GN1285A0</td> <td>NTC<br/>TEMPERATUR<br/>E PROBE<br/>SEALING</td> <td>1</td> <td>PZ</td> </tr> <tr> <td>SL1045A0</td> <td>S53 BLACK<br/>SILICONE -<br/>80ML<br/>CARTRIDGE</td> <td>1</td> <td>PZ</td> </tr> <tr> <td>TR1105A4</td> <td></td> <td>1</td> <td>PZ</td> </tr> <tr> <td>VI1220A1</td> <td>4,2X12 TCB<br/>SELF-TAPPIN<br/>G SCREW</td> <td>2</td> <td>PZ</td> </tr> </tbody> </table>   | Code | Description | Qty | UOM | GN1120A0 | TEMPERATUR<br>E PROBE NTC<br>SEAL       | 1 | PZ | GN1285A0 | NTC<br>TEMPERATUR<br>E PROBE<br>SEALING      | 1 | PZ | SL1045A0 | S53 BLACK<br>SILICONE -<br>80ML<br>CARTRIDGE | 1 | PZ | TR1105A4 |                                      | 1 | PZ | VI1220A1 | 4,2X12 TCB<br>SELF-TAPPIN<br>G SCREW      | 2 | PZ |
| Code      | Description                                  | Qty  | UOM        |   |   |      |             |     |     |          |   |   |    |          |  |   |    |          |  |   |    |          |                                      |   |    |          |   |   |    |
| GN1120A0  | TEMPERATUR<br>E PROBE NTC<br>SEAL            | 1  | PZ         |   |   |      |             |     |     |          |   |   |    |          |  |   |    |          |  |   |    |          |                                      |   |    |          |   |   |    |
| GN1285A0  | NTC<br>TEMPERATUR<br>E PROBE<br>SEALING      | 1  | PZ         |   |   |      |             |     |     |          |   |   |    |          |  |   |    |          |  |   |    |          |                                      |   |    |          |   |   |    |
| SL1045A0  | S53 BLACK<br>SILICONE -<br>80ML<br>CARTRIDGE | 1  | PZ         |   |   |      |             |     |     |          |   |   |    |          |  |   |    |          |  |   |    |          |                                      |   |    |          |   |   |    |
| TR1105A4  |  | 1  | PZ         |   |   |      |             |     |     |          |   |   |    |          |  |   |    |          |  |   |    |          |                                      |   |    |          |   |   |    |
| VI1220A1  | 4,2X12 TCB<br>SELF-TAPPIN<br>G SCREW         | 2  | PZ         |   |   |      |             |     |     |          |   |   |    |          |  |   |    |          |  |   |    |          |                                      |   |    |          |   |   |    |
|           |  |  | KTR1096A   | NTC 150 L=1500<br>TEMPERATURE<br>PROBE KIT  | <table border="1"> <thead> <tr> <th>Code</th> <th>Description</th> <th>Qty</th> <th>UOM</th> </tr> </thead> <tbody> <tr> <td>GN1120A0</td> <td>TEMPERATUR<br/>E PROBE NTC<br/>SEAL</td> <td>1</td> <td>PZ</td> </tr> </tbody> </table>  | Code | Description | Qty | UOM | GN1120A0 | TEMPERATUR<br>E PROBE NTC<br>SEAL       | 1 | PZ |          |  |   |    |          |  |   |    |          |                                      |   |    |          |   |   |    |
| Code      | Description                                  | Qty  | UOM        |   |   |      |             |     |     |          |   |   |    |          |  |   |    |          |  |   |    |          |                                      |   |    |          |   |   |    |
| GN1120A0  | TEMPERATUR<br>E PROBE NTC<br>SEAL            | 1  | PZ         |   |   |      |             |     |     |          |   |   |    |          |  |   |    |          |  |   |    |          |                                      |   |    |          |   |   |    |



| COMPONENT |  |  | SPARE PART |  |   |      |             |   |     |          |   |  |    |          |  |  |    |          |   |   |    |          |                                      |   |    |          |   |   |    |    |
|-----------|--|--|------------|--|---|------|-------------|---|-----|----------|---|--|----|----------|--|--|----|----------|---|---|----|----------|--------------------------------------|---|----|----------|---|---|----|----|
| Code      | Description                                  | Image  | Code       | Description                                | Components list   |      |             |   |     |          |   |  |    |          |  |  |    |          |   |   |    |          |                                      |   |    |          |   |   |    |    |
| GN1285A   | NTC TEMPERATURE<br>PROBE SEALING             |   | KTR1096A   | NTC 150 L=1500<br>TEMPERATURE<br>PROBE KIT | <table border="1"> <thead> <tr> <th>Code</th> <th>Description</th> <th>Qty</th> <th>UOM</th> </tr> </thead> <tbody> <tr> <td>GN1285A0</td> <td>NTC<br/>TEMPERATUR<br/>E PROBE<br/>SEALING</td> <td>2</td> <td>PZ</td> </tr> <tr> <td>SL1045A0</td> <td>S53 BLACK<br/>SILICONE -<br/>80ML<br/>CARTRIDGE</td> <td>1</td> <td>PZ</td> </tr> <tr> <td>TR1096A0</td> <td>TEMPERATUR<br/>E PROBE NTC<br/>150 L=1500</td> <td>1</td> <td>PZ</td> </tr> <tr> <td>VI1220A1</td> <td>4,2X12 TCB<br/>SELF-TAPPIN<br/>G SCREW</td> <td>2</td> <td>PZ</td> </tr> <tr> <td>VM1465A0</td> <td>CHEFTOP<br/>TEMPERATUR<br/>E PROBE<br/>COVER</td> <td>1</td> <td>PZ</td> </tr> </tbody> </table> | Code | Description | Qty                                     | UOM | GN1285A0 | NTC<br>TEMPERATUR<br>E PROBE<br>SEALING | 2  | PZ | SL1045A0 | S53 BLACK<br>SILICONE -<br>80ML<br>CARTRIDGE | 1  | PZ | TR1096A0 | TEMPERATUR<br>E PROBE NTC<br>150 L=1500 | 1                                       | PZ | VI1220A1 | 4,2X12 TCB<br>SELF-TAPPIN<br>G SCREW | 2   | PZ | VM1465A0 | CHEFTOP<br>TEMPERATUR<br>E PROBE<br>COVER | 1   | PZ |    |
|           |  |  | Code       | Description                                | Qty   | UOM  |             |   |     |          |   |  |    |          |  |  |    |          |   |   |    |          |                                      |   |    |          |   |   |    |    |
|           |  |  | GN1285A0   | NTC<br>TEMPERATUR<br>E PROBE<br>SEALING    | 2   | PZ   |             |   |     |          |   |  |    |          |  |  |    |          |   |   |    |          |                                      |   |    |          |   |   |    |    |
| SL1045A0  | S53 BLACK<br>SILICONE -<br>80ML<br>CARTRIDGE | 1  | PZ         |  |   |      |             |   |     |          |   |  |    |          |  |  |    |          |   |   |    |          |                                      |   |    |          |   |   |    |    |
| TR1096A0  | TEMPERATUR<br>E PROBE NTC<br>150 L=1500      | 1  | PZ         |  |   |      |             |   |     |          |   |  |    |          |  |  |    |          |   |   |    |          |                                      |   |    |          |   |   |    |    |
| VI1220A1  | 4,2X12 TCB<br>SELF-TAPPIN<br>G SCREW         | 2  | PZ         |  |   |      |             |   |     |          |   |  |    |          |  |  |    |          |   |   |    |          |                                      |   |    |          |   |   |    |    |
| VM1465A0  | CHEFTOP<br>TEMPERATUR<br>E PROBE<br>COVER    | 1  | PZ         |  |   |      |             |   |     |          |   |  |    |          |  |  |    |          |   |   |    |          |                                      |   |    |          |   |   |    |    |
| KTR1095A  | NTC 150 L=1050<br>TEMPERATURE<br>PROBE KIT   | <table border="1"> <thead> <tr> <th>Code</th> <th>Description</th> <th>Qty</th> <th>UOM</th> </tr> </thead> <tbody> <tr> <td>GN1120A0</td> <td>TEMPERATUR<br/>E PROBE NTC<br/>SEAL</td> <td>1</td> <td>PZ</td> </tr> <tr> <td>GN1285A0</td> <td>NTC<br/>TEMPERATUR<br/>E PROBE<br/>SEALING</td> <td>1</td> <td>PZ</td> </tr> <tr> <td>SL1045A0</td> <td>S53 BLACK<br/>SILICONE -<br/>80ML<br/>CARTRIDGE</td> <td>1</td> <td>PZ</td> </tr> <tr> <td>TR1095A0</td> <td>TEMPERATUR<br/>E PROBE NTC<br/>150 L=1050</td> <td>1</td> <td>PZ</td> </tr> <tr> <td>VI1220A1</td> <td>4,2X12 TCB<br/>SELF-TAPPIN<br/>G SCREW</td> <td>2</td> <td>PZ</td> </tr> <tr> <td>VM1465A0</td> <td>CHEFTOP<br/>TEMPERATUR<br/>E PROBE<br/>COVER</td> <td>1</td> <td>PZ</td> </tr> </tbody> </table> | Code       | Description                                | Qty   | UOM  | GN1120A0    | TEMPERATUR<br>E PROBE NTC<br>SEAL       | 1   | PZ       | GN1285A0                                | NTC<br>TEMPERATUR<br>E PROBE<br>SEALING      | 1  | PZ       | SL1045A0                                     | S53 BLACK<br>SILICONE -<br>80ML<br>CARTRIDGE | 1  | PZ       | TR1095A0                                | TEMPERATUR<br>E PROBE NTC<br>150 L=1050 | 1  | PZ       | VI1220A1                             | 4,2X12 TCB<br>SELF-TAPPIN<br>G SCREW      | 2  | PZ       | VM1465A0                                  | CHEFTOP<br>TEMPERATUR<br>E PROBE<br>COVER | 1  | PZ |
| Code      | Description                                  | Qty  | UOM        |  |   |      |             |   |     |          |   |  |    |          |  |  |    |          |   |   |    |          |                                      |   |    |          |   |   |    |    |
| GN1120A0  | TEMPERATUR<br>E PROBE NTC<br>SEAL            | 1  | PZ         |  |   |      |             |   |     |          |   |  |    |          |  |  |    |          |   |   |    |          |                                      |   |    |          |   |   |    |    |
| GN1285A0  | NTC<br>TEMPERATUR<br>E PROBE<br>SEALING      | 1  | PZ         |  |   |      |             |   |     |          |   |  |    |          |  |  |    |          |   |   |    |          |                                      |   |    |          |   |   |    |    |
| SL1045A0  | S53 BLACK<br>SILICONE -<br>80ML<br>CARTRIDGE | 1  | PZ         |  |   |      |             |   |     |          |   |  |    |          |  |  |    |          |   |   |    |          |                                      |   |    |          |   |   |    |    |
| TR1095A0  | TEMPERATUR<br>E PROBE NTC<br>150 L=1050      | 1  | PZ         |  |   |      |             |   |     |          |   |  |    |          |  |  |    |          |   |   |    |          |                                      |   |    |          |   |   |    |    |
| VI1220A1  | 4,2X12 TCB<br>SELF-TAPPIN<br>G SCREW         | 2  | PZ         |  |   |      |             |   |     |          |   |  |    |          |  |  |    |          |   |   |    |          |                                      |   |    |          |   |   |    |    |
| VM1465A0  | CHEFTOP<br>TEMPERATUR<br>E PROBE<br>COVER    | 1  | PZ         |  |   |      |             |   |     |          |   |  |    |          |  |  |    |          |   |   |    |          |                                      |   |    |          |   |   |    |    |
| KTR1002A  | PT100 L1000 UL<br>TEMPERATURE<br>PROBE KIT   | <table border="1"> <thead> <tr> <th>Code</th> <th>Description</th> <th>Qty</th> <th>UOM</th> </tr> </thead> <tbody> <tr> <td>GN1285A0</td> <td>NTC<br/>TEMPERATUR<br/>E PROBE<br/>SEALING</td> <td>2</td> <td>PZ</td> </tr> <tr> <td>SL1045A0</td> <td>S53 BLACK<br/>SILICONE -<br/>80ML<br/>CARTRIDGE</td> <td>1</td> <td>PZ</td> </tr> <tr> <td>TR1002A1</td> <td></td> <td>1</td> <td>PZ</td> </tr> <tr> <td>VI1220A1</td> <td>4,2X12 TCB<br/>SELF-TAPPIN<br/>G SCREW</td> <td>2</td> <td>PZ</td> </tr> <tr> <td>VM1465A0</td> <td>CHEFTOP<br/>TEMPERATUR<br/>E PROBE<br/>COVER</td> <td>1</td> <td>PZ</td> </tr> </tbody> </table>   | Code       | Description                                | Qty   | UOM  | GN1285A0    | NTC<br>TEMPERATUR<br>E PROBE<br>SEALING | 2   | PZ       | SL1045A0                                | S53 BLACK<br>SILICONE -<br>80ML<br>CARTRIDGE | 1  | PZ       | TR1002A1                                     |  | 1  | PZ       | VI1220A1                                | 4,2X12 TCB<br>SELF-TAPPIN<br>G SCREW    | 2  | PZ       | VM1465A0                             | CHEFTOP<br>TEMPERATUR<br>E PROBE<br>COVER | 1  | PZ       |   |   |    |    |
| Code      | Description                                  | Qty  | UOM        |  |   |      |             |   |     |          |   |  |    |          |  |  |    |          |   |   |    |          |                                      |   |    |          |   |   |    |    |
| GN1285A0  | NTC<br>TEMPERATUR<br>E PROBE<br>SEALING      | 2  | PZ         |  |   |      |             |   |     |          |   |  |    |          |  |  |    |          |   |   |    |          |                                      |   |    |          |   |   |    |    |
| SL1045A0  | S53 BLACK<br>SILICONE -<br>80ML<br>CARTRIDGE | 1  | PZ         |  |   |      |             |   |     |          |   |  |    |          |  |  |    |          |   |   |    |          |                                      |   |    |          |   |   |    |    |
| TR1002A1  |  | 1  | PZ         |  |   |      |             |   |     |          |   |  |    |          |  |  |    |          |   |   |    |          |                                      |   |    |          |   |   |    |    |
| VI1220A1  | 4,2X12 TCB<br>SELF-TAPPIN<br>G SCREW         | 2  | PZ         |  |   |      |             |   |     |          |   |  |    |          |  |  |    |          |   |   |    |          |                                      |   |    |          |   |   |    |    |
| VM1465A0  | CHEFTOP<br>TEMPERATUR<br>E PROBE<br>COVER    | 1  | PZ         |  |   |      |             |   |     |          |   |  |    |          |  |  |    |          |   |   |    |          |                                      |   |    |          |   |   |    |    |

| COMPONENT |  |   | SPARE PART |   |  |      |             |   |     |          |   |  |    |          |  |                                       |    |          |          |                                      |    |          |                                      |   |    |          |   |   |    |          |   |   |    |
|-----------|--|---|------------|---|--|------|-------------|---|-----|----------|---|--|----|----------|--|---------------------------------------|----|----------|----------|--------------------------------------|----|----------|--------------------------------------|---|----|----------|---|---|----|----------|---|---|----|
| Code      | Description                                  | Image   | Code       | Description                                   | Components list  |      |             |   |     |          |   |  |    |          |  |                                       |    |          |          |                                      |    |          |                                      |   |    |          |   |   |    |          |   |   |    |
| TR1106A   | PT100 L=2000<br>TEMPERATURE<br>PROBE         |    | KTR1106B   | MIND.MAPS L2000<br>CHAMBER TEMP.<br>PROBE KIT | <table border="1"> <thead> <tr> <th>Code</th> <th>Description</th> <th>Qty</th> <th>UOM</th> </tr> </thead> <tbody> <tr> <td>GN1285A0</td> <td>NTC<br/>TEMPERATUR<br/>E PROBE<br/>SEALING</td> <td>1</td> <td>PZ</td> </tr> <tr> <td>SL1045A0</td> <td>S53 BLACK<br/>SILICONE -<br/>80ML<br/>CARTRIDGE</td> <td>1</td> <td>PZ</td> </tr> <tr> <td>TR1106B0</td> <td></td> <td>1</td> <td>PZ</td> </tr> <tr> <td>VI1220A1</td> <td>4,2X12 TCB<br/>SELF-TAPPIN<br/>G SCREW</td> <td>2</td> <td>PZ</td> </tr> <tr> <td>VM1464A1</td> <td>CT BT<br/>TEMPERATUR<br/>E PROBE<br/>COVER</td> <td>1</td> <td>PZ</td> </tr> <tr> <td>VM1465A0</td> <td>CHEFTOP<br/>TEMPERATUR<br/>E PROBE<br/>COVER</td> <td>1</td> <td>PZ</td> </tr> </tbody> </table> | Code | Description | Qty                                     | UOM | GN1285A0 | NTC<br>TEMPERATUR<br>E PROBE<br>SEALING | 1  | PZ | SL1045A0 | S53 BLACK<br>SILICONE -<br>80ML<br>CARTRIDGE | 1                                     | PZ | TR1106B0 |          | 1                                    | PZ | VI1220A1 | 4,2X12 TCB<br>SELF-TAPPIN<br>G SCREW | 2   | PZ | VM1464A1 | CT BT<br>TEMPERATUR<br>E PROBE<br>COVER | 1 | PZ | VM1465A0 | CHEFTOP<br>TEMPERATUR<br>E PROBE<br>COVER | 1 | PZ |
|           |  |   | Code       | Description                                   | Qty  | UOM  |             |   |     |          |   |  |    |          |  |                                       |    |          |          |                                      |    |          |                                      |   |    |          |   |   |    |          |   |   |    |
| GN1285A0  | NTC<br>TEMPERATUR<br>E PROBE<br>SEALING      | 1   | PZ         |   |  |      |             |   |     |          |   |  |    |          |  |                                       |    |          |          |                                      |    |          |                                      |   |    |          |   |   |    |          |   |   |    |
| SL1045A0  | S53 BLACK<br>SILICONE -<br>80ML<br>CARTRIDGE | 1   | PZ         |   |  |      |             |   |     |          |   |  |    |          |  |                                       |    |          |          |                                      |    |          |                                      |   |    |          |   |   |    |          |   |   |    |
| TR1106B0  |  | 1   | PZ         |   |  |      |             |   |     |          |   |  |    |          |  |                                       |    |          |          |                                      |    |          |                                      |   |    |          |   |   |    |          |   |   |    |
| VI1220A1  | 4,2X12 TCB<br>SELF-TAPPIN<br>G SCREW         | 2   | PZ         |   |  |      |             |   |     |          |   |  |    |          |  |                                       |    |          |          |                                      |    |          |                                      |   |    |          |   |   |    |          |   |   |    |
| VM1464A1  | CT BT<br>TEMPERATUR<br>E PROBE<br>COVER      | 1   | PZ         |   |  |      |             |   |     |          |   |  |    |          |  |                                       |    |          |          |                                      |    |          |                                      |   |    |          |   |   |    |          |   |   |    |
| VM1465A0  | CHEFTOP<br>TEMPERATUR<br>E PROBE<br>COVER    | 1   | PZ         |   |  |      |             |   |     |          |   |  |    |          |  |                                       |    |          |          |                                      |    |          |                                      |   |    |          |   |   |    |          |   |   |    |
| KTR1106A  | 5-5E S. L2000<br>CHAMBER TEMP.<br>PROBE KIT  | <table border="1"> <thead> <tr> <th>Code</th> <th>Description</th> <th>Qty</th> <th>UOM</th> </tr> </thead> <tbody> <tr> <td>GN1285A0</td> <td>NTC<br/>TEMPERATUR<br/>E PROBE<br/>SEALING</td> <td>1</td> <td>PZ</td> </tr> <tr> <td>SL1045A0</td> <td>S53 BLACK<br/>SILICONE -<br/>80ML<br/>CARTRIDGE</td> <td>1</td> <td>PZ</td> </tr> <tr> <td>TR1106A3</td> <td>PT100 L=2000<br/>TEMPERATUR<br/>E PROBE</td> <td>1</td> <td>PZ</td> </tr> <tr> <td>VI1220A1</td> <td>4,2X12 TCB<br/>SELF-TAPPIN<br/>G SCREW</td> <td>2</td> <td>PZ</td> </tr> <tr> <td>VM1465A0</td> <td>CHEFTOP<br/>TEMPERATUR<br/>E PROBE<br/>COVER</td> <td>1</td> <td>PZ</td> </tr> </tbody> </table> | Code       | Description                                   | Qty  | UOM  | GN1285A0    | NTC<br>TEMPERATUR<br>E PROBE<br>SEALING | 1   | PZ       | SL1045A0                                | S53 BLACK<br>SILICONE -<br>80ML<br>CARTRIDGE | 1  | PZ       | TR1106A3                                     | PT100 L=2000<br>TEMPERATUR<br>E PROBE | 1  | PZ       | VI1220A1 | 4,2X12 TCB<br>SELF-TAPPIN<br>G SCREW | 2  | PZ       | VM1465A0                             | CHEFTOP<br>TEMPERATUR<br>E PROBE<br>COVER | 1  | PZ       |   |   |    |          |   |   |    |
| Code      | Description                                  | Qty   | UOM        |   |  |      |             |   |     |          |   |  |    |          |  |                                       |    |          |          |                                      |    |          |                                      |   |    |          |   |   |    |          |   |   |    |
| GN1285A0  | NTC<br>TEMPERATUR<br>E PROBE<br>SEALING      | 1   | PZ         |   |  |      |             |   |     |          |   |  |    |          |  |                                       |    |          |          |                                      |    |          |                                      |   |    |          |   |   |    |          |   |   |    |
| SL1045A0  | S53 BLACK<br>SILICONE -<br>80ML<br>CARTRIDGE | 1   | PZ         |   |  |      |             |   |     |          |   |  |    |          |  |                                       |    |          |          |                                      |    |          |                                      |   |    |          |   |   |    |          |   |   |    |
| TR1106A3  | PT100 L=2000<br>TEMPERATUR<br>E PROBE        | 1   | PZ         |   |  |      |             |   |     |          |   |  |    |          |  |                                       |    |          |          |                                      |    |          |                                      |   |    |          |   |   |    |          |   |   |    |
| VI1220A1  | 4,2X12 TCB<br>SELF-TAPPIN<br>G SCREW         | 2   | PZ         |   |  |      |             |   |     |          |   |  |    |          |  |                                       |    |          |          |                                      |    |          |                                      |   |    |          |   |   |    |          |   |   |    |
| VM1465A0  | CHEFTOP<br>TEMPERATUR<br>E PROBE<br>COVER    | 1   | PZ         |   |  |      |             |   |     |          |   |  |    |          |  |                                       |    |          |          |                                      |    |          |                                      |   |    |          |   |   |    |          |   |   |    |
| VM1464A   | CT BT<br>TEMPERATURE<br>PROBE COVER          |    | KVM1464A   | CT BT<br>TEMPERATURE<br>PROBE COVER KIT       | <table border="1"> <thead> <tr> <th>Code</th> <th>Description</th> <th>Qty</th> <th>UOM</th> </tr> </thead> <tbody> <tr> <td>VM1464A1</td> <td>CT BT<br/>TEMPERATUR<br/>E PROBE<br/>COVER</td> <td>1</td> <td>PZ</td> </tr> </tbody> </table>  | Code | Description | Qty                                     | UOM | VM1464A1 | CT BT<br>TEMPERATUR<br>E PROBE<br>COVER | 1  | PZ |          |  |                                       |    |          |          |                                      |    |          |                                      |   |    |          |   |   |    |          |   |   |    |
| Code      | Description                                  | Qty   | UOM        |   |  |      |             |   |     |          |   |  |    |          |  |                                       |    |          |          |                                      |    |          |                                      |   |    |          |   |   |    |          |   |   |    |
| VM1464A1  | CT BT<br>TEMPERATUR<br>E PROBE<br>COVER      | 1   | PZ         |   |  |      |             |   |     |          |   |  |    |          |  |                                       |    |          |          |                                      |    |          |                                      |   |    |          |   |   |    |          |   |   |    |



| COMPONENT |  |   | SPARE PART |   |  |      |             |     |     |          |   |   |    |          |  |   |    |          |  |   |    |          |                                      |   |    |          |   |   |    |          |   |   |    |
|-----------|--|---|------------|---|--|------|-------------|-----|-----|----------|---|---|----|----------|--|---|----|----------|--|---|----|----------|--------------------------------------|---|----|----------|---|---|----|----------|---|---|----|
| Code      | Description                                    | Image   | Code       | Description                               | Components list  |      |             |     |     |          |   |   |    |          |  |   |    |          |  |   |    |          |                                      |   |    |          |   |   |    |          |   |   |    |
| TR1003A   | PT100 L2000<br>TEMPERATURE<br>PROBE-US VERSION |    | KTR1003B   | US MM L2000<br>CHAMBER TEMP.<br>PROBE KIT | <table border="1"> <thead> <tr> <th>Code</th> <th>Description</th> <th>Qty</th> <th>UOM</th> </tr> </thead> <tbody> <tr> <td>GN1285A0</td> <td>NTC<br/>TEMPERATUR<br/>E PROBE<br/>SEALING</td> <td>1</td> <td>PZ</td> </tr> <tr> <td>SL1045A0</td> <td>S53 BLACK<br/>SILICONE -<br/>80ML<br/>CARTRIDGE</td> <td>1</td> <td>PZ</td> </tr> <tr> <td>TR1003B0</td> <td></td> <td>1</td> <td>PZ</td> </tr> <tr> <td>VI1220A1</td> <td>4,2X12 TCB<br/>SELF-TAPPIN<br/>G SCREW</td> <td>2</td> <td>PZ</td> </tr> <tr> <td>VM1464A1</td> <td>CT BT<br/>TEMPERATUR<br/>E PROBE<br/>COVER</td> <td>1</td> <td>PZ</td> </tr> <tr> <td>VM1465A0</td> <td>CHEFTOP<br/>TEMPERATUR<br/>E PROBE<br/>COVER</td> <td>1</td> <td>PZ</td> </tr> </tbody> </table> | Code | Description | Qty | UOM | GN1285A0 | NTC<br>TEMPERATUR<br>E PROBE<br>SEALING | 1 | PZ | SL1045A0 | S53 BLACK<br>SILICONE -<br>80ML<br>CARTRIDGE | 1 | PZ | TR1003B0 |  | 1 | PZ | VI1220A1 | 4,2X12 TCB<br>SELF-TAPPIN<br>G SCREW | 2 | PZ | VM1464A1 | CT BT<br>TEMPERATUR<br>E PROBE<br>COVER | 1 | PZ | VM1465A0 | CHEFTOP<br>TEMPERATUR<br>E PROBE<br>COVER | 1 | PZ |
| Code      | Description                                    | Qty   | UOM        |   |  |      |             |     |     |          |   |   |    |          |  |   |    |          |  |   |    |          |                                      |   |    |          |   |   |    |          |   |   |    |
| GN1285A0  | NTC<br>TEMPERATUR<br>E PROBE<br>SEALING        | 1   | PZ         |   |  |      |             |     |     |          |   |   |    |          |  |   |    |          |  |   |    |          |                                      |   |    |          |   |   |    |          |   |   |    |
| SL1045A0  | S53 BLACK<br>SILICONE -<br>80ML<br>CARTRIDGE   | 1   | PZ         |   |  |      |             |     |     |          |   |   |    |          |  |   |    |          |  |   |    |          |                                      |   |    |          |   |   |    |          |   |   |    |
| TR1003B0  |  | 1   | PZ         |   |  |      |             |     |     |          |   |   |    |          |  |   |    |          |  |   |    |          |                                      |   |    |          |   |   |    |          |   |   |    |
| VI1220A1  | 4,2X12 TCB<br>SELF-TAPPIN<br>G SCREW           | 2   | PZ         |   |  |      |             |     |     |          |   |   |    |          |  |   |    |          |  |   |    |          |                                      |   |    |          |   |   |    |          |   |   |    |
| VM1464A1  | CT BT<br>TEMPERATUR<br>E PROBE<br>COVER        | 1   | PZ         |   |  |      |             |     |     |          |   |   |    |          |  |   |    |          |  |   |    |          |                                      |   |    |          |   |   |    |          |   |   |    |
| VM1465A0  | CHEFTOP<br>TEMPERATUR<br>E PROBE<br>COVER      | 1   | PZ         |   |  |      |             |     |     |          |   |   |    |          |  |   |    |          |  |   |    |          |                                      |   |    |          |   |   |    |          |   |   |    |
| GN1531A   | THERMOSTAT BULB<br>INLET SEALING               |  | KTR1136A   | 330°C SAFETY<br>THERMOSTAT KIT            | <table border="1"> <thead> <tr> <th>Code</th> <th>Description</th> <th>Qty</th> <th>UOM</th> </tr> </thead> <tbody> <tr> <td>0H7030A0</td> <td>THERMOSTAT<br/>BULB INLET<br/>COVER</td> <td>1</td> <td>PZ</td> </tr> <tr> <td>GN1531A0</td> <td>THERMOSTAT<br/>BULB INLET<br/>SEALING</td> <td>1</td> <td>PZ</td> </tr> <tr> <td>SL1045A0</td> <td>S53 BLACK<br/>SILICONE -<br/>80ML<br/>CARTRIDGE</td> <td>1</td> <td>PZ</td> </tr> <tr> <td>TR1136A0</td> <td>330°C 1 POLE<br/>SAFETY<br/>THERMOSTAT</td> <td>1</td> <td>PZ</td> </tr> <tr> <td>VI1220A1</td> <td>4,2X12 TCB<br/>SELF-TAPPIN<br/>G SCREW</td> <td>3</td> <td>PZ</td> </tr> </tbody> </table>   | Code | Description | Qty | UOM | 0H7030A0 | THERMOSTAT<br>BULB INLET<br>COVER       | 1 | PZ | GN1531A0 | THERMOSTAT<br>BULB INLET<br>SEALING          | 1 | PZ | SL1045A0 | S53 BLACK<br>SILICONE -<br>80ML<br>CARTRIDGE | 1 | PZ | TR1136A0 | 330°C 1 POLE<br>SAFETY<br>THERMOSTAT | 1 | PZ | VI1220A1 | 4,2X12 TCB<br>SELF-TAPPIN<br>G SCREW    | 3 | PZ |          |   |   |    |
| Code      | Description                                    | Qty   | UOM        |   |  |      |             |     |     |          |   |   |    |          |  |   |    |          |  |   |    |          |                                      |   |    |          |   |   |    |          |   |   |    |
| 0H7030A0  | THERMOSTAT<br>BULB INLET<br>COVER              | 1   | PZ         |   |  |      |             |     |     |          |   |   |    |          |  |   |    |          |  |   |    |          |                                      |   |    |          |   |   |    |          |   |   |    |
| GN1531A0  | THERMOSTAT<br>BULB INLET<br>SEALING            | 1   | PZ         |   |  |      |             |     |     |          |   |   |    |          |  |   |    |          |  |   |    |          |                                      |   |    |          |   |   |    |          |   |   |    |
| SL1045A0  | S53 BLACK<br>SILICONE -<br>80ML<br>CARTRIDGE   | 1   | PZ         |   |  |      |             |     |     |          |   |   |    |          |  |   |    |          |  |   |    |          |                                      |   |    |          |   |   |    |          |   |   |    |
| TR1136A0  | 330°C 1 POLE<br>SAFETY<br>THERMOSTAT           | 1   | PZ         |   |  |      |             |     |     |          |   |   |    |          |  |   |    |          |  |   |    |          |                                      |   |    |          |   |   |    |          |   |   |    |
| VI1220A1  | 4,2X12 TCB<br>SELF-TAPPIN<br>G SCREW           | 3   | PZ         |   |  |      |             |     |     |          |   |   |    |          |  |   |    |          |  |   |    |          |                                      |   |    |          |   |   |    |          |   |   |    |
| 0H7030A   | THERMOSTAT BULB<br>INLET COVER                 |  | K0H7030A   | THERMOSTAT BULB<br>INLET COVER KIT        | <table border="1"> <thead> <tr> <th>Code</th> <th>Description</th> <th>Qty</th> <th>UOM</th> </tr> </thead> <tbody> <tr> <td>0H7030A0</td> <td>THERMOSTAT<br/>BULB INLET<br/>COVER</td> <td>1</td> <td>PZ</td> </tr> </tbody> </table>   | Code | Description | Qty | UOM | 0H7030A0 | THERMOSTAT<br>BULB INLET<br>COVER       | 1 | PZ |          |  |   |    |          |  |   |    |          |                                      |   |    |          |   |   |    |          |   |   |    |
| Code      | Description                                    | Qty   | UOM        |   |  |      |             |     |     |          |   |   |    |          |  |   |    |          |  |   |    |          |                                      |   |    |          |   |   |    |          |   |   |    |
| 0H7030A0  | THERMOSTAT<br>BULB INLET<br>COVER              | 1   | PZ         |   |  |      |             |     |     |          |   |   |    |          |  |   |    |          |  |   |    |          |                                      |   |    |          |   |   |    |          |   |   |    |





| COMPONENT |   |   | SPARE PART |                                     |   |      |             |     |     |          |   |    |    |
|-----------|---|---|------------|-------------------------------------|---|------|-------------|-----|-----|----------|---|----|----|
| Code      | Description                                     | Image   | Code       | Description                         | Components list   |      |             |     |     |          |   |    |    |
| 0H2551A   | XBC/XVC ST.STEEL<br>DRAIN COVER                 |    | 0H2551A0   | XBC/XVC ST.STEEL<br>DRAIN COVER     |   |      |             |     |     |          |   |    |    |
| 0H7320A   | 6 S. VENTURI PIPE<br>SUPPORT                    |    | 0H7320A0   | 6 S. VENTURI PIPE<br>SUPPORT        |   |      |             |     |     |          |   |    |    |
| VM1820A   | LATERAL<br>SUPPORTS M6<br>FIXING BOLT           |  | KVM1820A   | THUMB SCREW<br>10PCS KIT            | <table border="1"> <thead> <tr> <th>Code</th> <th>Description</th> <th>Qty</th> <th>UOM</th> </tr> </thead> <tbody> <tr> <td>VM1820A0</td> <td>LATERAL<br/>SUPPORTS<br/>M6 FIXING<br/>BOLT</td> <td>10</td> <td>PZ</td> </tr> </tbody> </table>       | Code | Description | Qty | UOM | VM1820A0 | LATERAL<br>SUPPORTS<br>M6 FIXING<br>BOLT        | 10 | PZ |
| Code      | Description                                     | Qty   | UOM        |                                     |   |      |             |     |     |          |   |    |    |
| VM1820A0  | LATERAL<br>SUPPORTS<br>M6 FIXING<br>BOLT        | 10  | PZ         |                                     |   |      |             |     |     |          |   |    |    |
| 0G1577A   | XEVC-2011-E FAN<br>GUARD                        |  |            |                                     |   |      |             |     |     |          |   |    |    |
| TB2917A   | XEVC-2011-E 5<br>WAYS WATER PIPE<br>ASSEMBLY    |  | KTB2917A   | XEVC-2011-E 5 WAY<br>WATER PIPE KIT | <table border="1"> <thead> <tr> <th>Code</th> <th>Description</th> <th>Qty</th> <th>UOM</th> </tr> </thead> <tbody> <tr> <td>TB2917A0</td> <td>XEVC-2011-E 5<br/>WAYS WATER<br/>PIPE<br/>ASSEMBLY</td> <td>1</td> <td>PZ</td> </tr> </tbody> </table> | Code | Description | Qty | UOM | TB2917A0 | XEVC-2011-E 5<br>WAYS WATER<br>PIPE<br>ASSEMBLY | 1  | PZ |
| Code      | Description                                     | Qty   | UOM        |                                     |   |      |             |     |     |          |   |    |    |
| TB2917A0  | XEVC-2011-E 5<br>WAYS WATER<br>PIPE<br>ASSEMBLY | 1   | PZ         |                                     |   |      |             |     |     |          |   |    |    |

| COMPONENT |  |   | SPARE PART |  |   |      |             |     |     |          |  |   |    |          |  |   |    |
|-----------|--|---|------------|--|---|------|-------------|-----|-----|----------|--|---|----|----------|--|---|----|
| Code      | Description                                  | Image   | Code       | Description                                    | Components list   |      |             |     |     |          |  |   |    |          |  |   |    |
| VM2251A   | STEAM WATER<br>INLET UPPER<br>DISTRIBUTOR    |    | KVM2251A   | STEAM WATER<br>INLET UP+LO<br>DISTRIBUTORS KIT | <table border="1"> <thead> <tr> <th>Code</th> <th>Description</th> <th>Qty</th> <th>UOM</th> </tr> </thead> <tbody> <tr> <td>VM2251A0</td> <td>STEAM<br/>WATER INLET<br/>UPPER<br/>DISTRIBUTOR</td> <td>1</td> <td>PZ</td> </tr> <tr> <td>VM2252A0</td> <td>STEAM<br/>WATER INLET<br/>LOWER<br/>DISTRIBUTOR</td> <td>1</td> <td>PZ</td> </tr> </tbody> </table> | Code | Description | Qty | UOM | VM2251A0 | STEAM<br>WATER INLET<br>UPPER<br>DISTRIBUTOR | 1 | PZ | VM2252A0 | STEAM<br>WATER INLET<br>LOWER<br>DISTRIBUTOR | 1 | PZ |
| Code      | Description                                  | Qty   | UOM        |  |   |      |             |     |     |          |  |   |    |          |  |   |    |
| VM2251A0  | STEAM<br>WATER INLET<br>UPPER<br>DISTRIBUTOR | 1   | PZ         |  |   |      |             |     |     |          |  |   |    |          |  |   |    |
| VM2252A0  | STEAM<br>WATER INLET<br>LOWER<br>DISTRIBUTOR | 1   | PZ         |  |   |      |             |     |     |          |  |   |    |          |  |   |    |
| VM2252A   | STEAM WATER<br>INLET LOWER<br>DISTRIBUTOR    |   | KVM2251A   | STEAM WATER<br>INLET UP+LO<br>DISTRIBUTORS KIT | <table border="1"> <thead> <tr> <th>Code</th> <th>Description</th> <th>Qty</th> <th>UOM</th> </tr> </thead> <tbody> <tr> <td>VM2251A0</td> <td>STEAM<br/>WATER INLET<br/>UPPER<br/>DISTRIBUTOR</td> <td>1</td> <td>PZ</td> </tr> <tr> <td>VM2252A0</td> <td>STEAM<br/>WATER INLET<br/>LOWER<br/>DISTRIBUTOR</td> <td>1</td> <td>PZ</td> </tr> </tbody> </table> | Code | Description | Qty | UOM | VM2251A0 | STEAM<br>WATER INLET<br>UPPER<br>DISTRIBUTOR | 1 | PZ | VM2252A0 | STEAM<br>WATER INLET<br>LOWER<br>DISTRIBUTOR | 1 | PZ |
| Code      | Description                                  | Qty   | UOM        |  |   |      |             |     |     |          |  |   |    |          |  |   |    |
| VM2251A0  | STEAM<br>WATER INLET<br>UPPER<br>DISTRIBUTOR | 1   | PZ         |  |   |      |             |     |     |          |  |   |    |          |  |   |    |
| VM2252A0  | STEAM<br>WATER INLET<br>LOWER<br>DISTRIBUTOR | 1   | PZ         |  |   |      |             |     |     |          |  |   |    |          |  |   |    |
| VM2251A   | STEAM WATER<br>INLET UPPER<br>DISTRIBUTOR    |  | KVM2251A   | STEAM WATER<br>INLET UP+LO<br>DISTRIBUTORS KIT | <table border="1"> <thead> <tr> <th>Code</th> <th>Description</th> <th>Qty</th> <th>UOM</th> </tr> </thead> <tbody> <tr> <td>VM2251A0</td> <td>STEAM<br/>WATER INLET<br/>UPPER<br/>DISTRIBUTOR</td> <td>1</td> <td>PZ</td> </tr> <tr> <td>VM2252A0</td> <td>STEAM<br/>WATER INLET<br/>LOWER<br/>DISTRIBUTOR</td> <td>1</td> <td>PZ</td> </tr> </tbody> </table> | Code | Description | Qty | UOM | VM2251A0 | STEAM<br>WATER INLET<br>UPPER<br>DISTRIBUTOR | 1 | PZ | VM2252A0 | STEAM<br>WATER INLET<br>LOWER<br>DISTRIBUTOR | 1 | PZ |
| Code      | Description                                  | Qty   | UOM        |  |   |      |             |     |     |          |  |   |    |          |  |   |    |
| VM2251A0  | STEAM<br>WATER INLET<br>UPPER<br>DISTRIBUTOR | 1   | PZ         |  |   |      |             |     |     |          |  |   |    |          |  |   |    |
| VM2252A0  | STEAM<br>WATER INLET<br>LOWER<br>DISTRIBUTOR | 1   | PZ         |  |   |      |             |     |     |          |  |   |    |          |  |   |    |
| VM2252A   | STEAM WATER<br>INLET LOWER<br>DISTRIBUTOR    |  | KVM2251A   | STEAM WATER<br>INLET UP+LO<br>DISTRIBUTORS KIT | <table border="1"> <thead> <tr> <th>Code</th> <th>Description</th> <th>Qty</th> <th>UOM</th> </tr> </thead> <tbody> <tr> <td>VM2251A0</td> <td>STEAM<br/>WATER INLET<br/>UPPER<br/>DISTRIBUTOR</td> <td>1</td> <td>PZ</td> </tr> <tr> <td>VM2252A0</td> <td>STEAM<br/>WATER INLET<br/>LOWER<br/>DISTRIBUTOR</td> <td>1</td> <td>PZ</td> </tr> </tbody> </table> | Code | Description | Qty | UOM | VM2251A0 | STEAM<br>WATER INLET<br>UPPER<br>DISTRIBUTOR | 1 | PZ | VM2252A0 | STEAM<br>WATER INLET<br>LOWER<br>DISTRIBUTOR | 1 | PZ |
| Code      | Description                                  | Qty   | UOM        |  |   |      |             |     |     |          |  |   |    |          |  |   |    |
| VM2251A0  | STEAM<br>WATER INLET<br>UPPER<br>DISTRIBUTOR | 1   | PZ         |  |   |      |             |     |     |          |  |   |    |          |  |   |    |
| VM2252A0  | STEAM<br>WATER INLET<br>LOWER<br>DISTRIBUTOR | 1   | PZ         |  |   |      |             |     |     |          |  |   |    |          |  |   |    |
| TB2918A   | XEVC-2011-E 4<br>WAYS WATER PIPE<br>ASSEMBLY |  | TB2918A0   | XEVC-2011-E 4<br>WAYS WATER PIPE<br>ASSEMBLY   |   |      |             |     |     |          |  |   |    |          |  |   |    |



| COMPONENT |  |   | SPARE PART |  |   |      |             |     |     |          |                                     |   |    |          |                                     |   |    |
|-----------|--|---|------------|--|---|------|-------------|-----|-----|----------|-------------------------------------|---|----|----------|-------------------------------------|---|----|
| Code      | Description                            | Image   | Code       | Description                              | Components list   |      |             |     |     |          |                                     |   |    |          |                                     |   |    |
| VM2251A   | STEAM WATER INLET UPPER DISTRIBUTOR    |    | KVM2251A   | STEAM WATER INLET UP+LO DISTRIBUTORS KIT | <table border="1"> <thead> <tr> <th>Code</th> <th>Description</th> <th>Qty</th> <th>UOM</th> </tr> </thead> <tbody> <tr> <td>VM2251A0</td> <td>STEAM WATER INLET UPPER DISTRIBUTOR</td> <td>1</td> <td>PZ</td> </tr> <tr> <td>VM2252A0</td> <td>STEAM WATER INLET LOWER DISTRIBUTOR</td> <td>1</td> <td>PZ</td> </tr> </tbody> </table> | Code | Description | Qty | UOM | VM2251A0 | STEAM WATER INLET UPPER DISTRIBUTOR | 1 | PZ | VM2252A0 | STEAM WATER INLET LOWER DISTRIBUTOR | 1 | PZ |
| Code      | Description                            | Qty   | UOM        |  |   |      |             |     |     |          |                                     |   |    |          |                                     |   |    |
| VM2251A0  | STEAM WATER INLET UPPER DISTRIBUTOR    | 1   | PZ         |  |   |      |             |     |     |          |                                     |   |    |          |                                     |   |    |
| VM2252A0  | STEAM WATER INLET LOWER DISTRIBUTOR    | 1   | PZ         |  |   |      |             |     |     |          |                                     |   |    |          |                                     |   |    |
| VM2252A   | STEAM WATER INLET LOWER DISTRIBUTOR    |   | KVM2251A   | STEAM WATER INLET UP+LO DISTRIBUTORS KIT | <table border="1"> <thead> <tr> <th>Code</th> <th>Description</th> <th>Qty</th> <th>UOM</th> </tr> </thead> <tbody> <tr> <td>VM2251A0</td> <td>STEAM WATER INLET UPPER DISTRIBUTOR</td> <td>1</td> <td>PZ</td> </tr> <tr> <td>VM2252A0</td> <td>STEAM WATER INLET LOWER DISTRIBUTOR</td> <td>1</td> <td>PZ</td> </tr> </tbody> </table> | Code | Description | Qty | UOM | VM2251A0 | STEAM WATER INLET UPPER DISTRIBUTOR | 1 | PZ | VM2252A0 | STEAM WATER INLET LOWER DISTRIBUTOR | 1 | PZ |
| Code      | Description                            | Qty   | UOM        |  |   |      |             |     |     |          |                                     |   |    |          |                                     |   |    |
| VM2251A0  | STEAM WATER INLET UPPER DISTRIBUTOR    | 1   | PZ         |  |   |      |             |     |     |          |                                     |   |    |          |                                     |   |    |
| VM2252A0  | STEAM WATER INLET LOWER DISTRIBUTOR    | 1   | PZ         |  |   |      |             |     |     |          |                                     |   |    |          |                                     |   |    |
| TB2919A   | XEVC-2011-E 3 WAYS WATER PIPE ASSEMBLY |  | TB2919A0   | XEVC-2011-E 3 WAYS WATER PIPE ASSEMBLY   |   |      |             |     |     |          |                                     |   |    |          |                                     |   |    |
| VM2251A   | STEAM WATER INLET UPPER DISTRIBUTOR    |  | KVM2251A   | STEAM WATER INLET UP+LO DISTRIBUTORS KIT | <table border="1"> <thead> <tr> <th>Code</th> <th>Description</th> <th>Qty</th> <th>UOM</th> </tr> </thead> <tbody> <tr> <td>VM2251A0</td> <td>STEAM WATER INLET UPPER DISTRIBUTOR</td> <td>1</td> <td>PZ</td> </tr> <tr> <td>VM2252A0</td> <td>STEAM WATER INLET LOWER DISTRIBUTOR</td> <td>1</td> <td>PZ</td> </tr> </tbody> </table> | Code | Description | Qty | UOM | VM2251A0 | STEAM WATER INLET UPPER DISTRIBUTOR | 1 | PZ | VM2252A0 | STEAM WATER INLET LOWER DISTRIBUTOR | 1 | PZ |
| Code      | Description                            | Qty   | UOM        |  |   |      |             |     |     |          |                                     |   |    |          |                                     |   |    |
| VM2251A0  | STEAM WATER INLET UPPER DISTRIBUTOR    | 1   | PZ         |  |   |      |             |     |     |          |                                     |   |    |          |                                     |   |    |
| VM2252A0  | STEAM WATER INLET LOWER DISTRIBUTOR    | 1   | PZ         |  |   |      |             |     |     |          |                                     |   |    |          |                                     |   |    |
| VM2252A   | STEAM WATER INLET LOWER DISTRIBUTOR    |  | KVM2251A   | STEAM WATER INLET UP+LO DISTRIBUTORS KIT | <table border="1"> <thead> <tr> <th>Code</th> <th>Description</th> <th>Qty</th> <th>UOM</th> </tr> </thead> <tbody> <tr> <td>VM2251A0</td> <td>STEAM WATER INLET UPPER DISTRIBUTOR</td> <td>1</td> <td>PZ</td> </tr> <tr> <td>VM2252A0</td> <td>STEAM WATER INLET LOWER DISTRIBUTOR</td> <td>1</td> <td>PZ</td> </tr> </tbody> </table> | Code | Description | Qty | UOM | VM2251A0 | STEAM WATER INLET UPPER DISTRIBUTOR | 1 | PZ | VM2252A0 | STEAM WATER INLET LOWER DISTRIBUTOR | 1 | PZ |
| Code      | Description                            | Qty   | UOM        |  |   |      |             |     |     |          |                                     |   |    |          |                                     |   |    |
| VM2251A0  | STEAM WATER INLET UPPER DISTRIBUTOR    | 1   | PZ         |  |   |      |             |     |     |          |                                     |   |    |          |                                     |   |    |
| VM2252A0  | STEAM WATER INLET LOWER DISTRIBUTOR    | 1   | PZ         |  |   |      |             |     |     |          |                                     |   |    |          |                                     |   |    |



| COMPONENT |  |   | SPARE PART |  |   |      |             |     |     |          |  |   |    |          |                       |   |    |          |                       |   |    |
|-----------|--|---|------------|--|---|------|-------------|-----|-----|----------|--|---|----|----------|-----------------------|---|----|----------|-----------------------|---|----|
| Code      | Description                                  | Image   | Code       | Description                                  | Components list   |      |             |     |     |          |  |   |    |          |                       |   |    |          |                       |   |    |
| TB2920A   | XEVC-2011-E 2<br>WAYS WATER PIPE<br>ASSEMBLY |    | TB2920A0   | XEVC-2011-E 2<br>WAYS WATER PIPE<br>ASSEMBLY |   |      |             |     |     |          |  |   |    |          |                       |   |    |          |                       |   |    |
| TB2921A   | XEVC-2011-E<br>LOWER WATER PIP               |    | TB2921A0   | XEVC-2011-E<br>LOWER WATER PIP               |   |      |             |     |     |          |  |   |    |          |                       |   |    |          |                       |   |    |
| VM2332A   | WATER PIPE<br>BUSHING                        |  | KVM2332A   | WATER PIPE<br>BUSHING KIT<br>VM2332A0        | <table border="1"> <thead> <tr> <th>Code</th> <th>Description</th> <th>Qty</th> <th>UOM</th> </tr> </thead> <tbody> <tr> <td>VM2332A0</td> <td>WATER PIPE<br/>BUSHING</td> <td>1</td> <td>PZ</td> </tr> <tr> <td>VM2332A0</td> <td>WATER PIPE<br/>BUSHING</td> <td>1</td> <td>PZ</td> </tr> </tbody> </table>   | Code | Description | Qty | UOM | VM2332A0 | WATER PIPE<br>BUSHING                  | 1 | PZ | VM2332A0 | WATER PIPE<br>BUSHING | 1 | PZ |          |                       |   |    |
| Code      | Description                                  | Qty   | UOM        |  |   |      |             |     |     |          |  |   |    |          |                       |   |    |          |                       |   |    |
| VM2332A0  | WATER PIPE<br>BUSHING                        | 1   | PZ         |  |   |      |             |     |     |          |  |   |    |          |                       |   |    |          |                       |   |    |
| VM2332A0  | WATER PIPE<br>BUSHING                        | 1   | PZ         |  |   |      |             |     |     |          |  |   |    |          |                       |   |    |          |                       |   |    |
| VM2350A   | CORE PROBE<br>SUPPORT                        |  | KVM2350A   | CORE PROBE<br>SUPPORT KIT                    | <table border="1"> <thead> <tr> <th>Code</th> <th>Description</th> <th>Qty</th> <th>UOM</th> </tr> </thead> <tbody> <tr> <td>V11220A1</td> <td>4,2X12 TCB<br/>SELF-TAPPIN<br/>G SCREW</td> <td>2</td> <td>PZ</td> </tr> <tr> <td>VM2350A0</td> <td>CORE PROBE<br/>SUPPORT</td> <td>1</td> <td>PZ</td> </tr> <tr> <td>VM2350A0</td> <td>CORE PROBE<br/>SUPPORT</td> <td>1</td> <td>PZ</td> </tr> </tbody> </table> | Code | Description | Qty | UOM | V11220A1 | 4,2X12 TCB<br>SELF-TAPPIN<br>G SCREW   | 2 | PZ | VM2350A0 | CORE PROBE<br>SUPPORT | 1 | PZ | VM2350A0 | CORE PROBE<br>SUPPORT | 1 | PZ |
| Code      | Description                                  | Qty   | UOM        |  |   |      |             |     |     |          |  |   |    |          |                       |   |    |          |                       |   |    |
| V11220A1  | 4,2X12 TCB<br>SELF-TAPPIN<br>G SCREW         | 2   | PZ         |  |   |      |             |     |     |          |  |   |    |          |                       |   |    |          |                       |   |    |
| VM2350A0  | CORE PROBE<br>SUPPORT                        | 1   | PZ         |  |   |      |             |     |     |          |  |   |    |          |                       |   |    |          |                       |   |    |
| VM2350A0  | CORE PROBE<br>SUPPORT                        | 1   | PZ         |  |   |      |             |     |     |          |  |   |    |          |                       |   |    |          |                       |   |    |
| GN1085A   | 141X24 HEATING<br>ELEMENT GASKET             |  | KG1085A    | HEATING ELEMENT<br>GASKET KIT                | <table border="1"> <thead> <tr> <th>Code</th> <th>Description</th> <th>Qty</th> <th>UOM</th> </tr> </thead> <tbody> <tr> <td>GN1085A2</td> <td>141X24<br/>HEATING<br/>ELEMENT<br/>GASKET</td> <td>1</td> <td>PZ</td> </tr> </tbody> </table>  | Code | Description | Qty | UOM | GN1085A2 | 141X24<br>HEATING<br>ELEMENT<br>GASKET | 1 | PZ |          |                       |   |    |          |                       |   |    |
| Code      | Description                                  | Qty   | UOM        |  |   |      |             |     |     |          |  |   |    |          |                       |   |    |          |                       |   |    |
| GN1085A2  | 141X24<br>HEATING<br>ELEMENT<br>GASKET       | 1   | PZ         |  |   |      |             |     |     |          |  |   |    |          |                       |   |    |          |                       |   |    |





| COMPONENT |                                    |   | SPARE PART |                            |  |                                     |             |     |     |          |                               |   |    |          |                                   |   |    |          |                                     |   |    |          |                       |   |    |          |                         |   |    |          |                               |   |    |          |                                 |   |    |          |                          |   |    |          |            |   |    |
|-----------|------------------------------------|---|------------|----------------------------|--|-------------------------------------|-------------|-----|-----|----------|-------------------------------|---|----|----------|-----------------------------------|---|----|----------|-------------------------------------|---|----|----------|-----------------------|---|----|----------|-------------------------|---|----|----------|-------------------------------|---|----|----------|---------------------------------|---|----|----------|--------------------------|---|----|----------|------------|---|----|
| Code      | Description                        | Image   | Code       | Description                | Components list  |                                     |             |     |     |          |                               |   |    |          |                                   |   |    |          |                                     |   |    |          |                       |   |    |          |                         |   |    |          |                               |   |    |          |                                 |   |    |          |                          |   |    |          |            |   |    |
| RS1205A   | 6 TURNS 5.6KW 230 HEATING ELEMENT  |    | KRS1205A   | 5.6KW HEATING ELEMENT KIT  | <table border="1"> <thead> <tr> <th>Code</th> <th>Description</th> <th>Qty</th> <th>UOM</th> </tr> </thead> <tbody> <tr> <td>GN1085A2</td> <td>141X24 HEATING ELEMENT GASKET</td> <td>1</td> <td>PZ</td> </tr> <tr> <td>RS1205A1</td> <td>6 TURNS 5.6KW 230 HEATING ELEMENT</td> <td>1</td> <td>PZ</td> </tr> <tr> <td>SL1045A0</td> <td>S53 BLACK SILICONE - 80ML CARTRIDGE</td> <td>1</td> <td>PZ</td> </tr> <tr> <td>VI1032A0</td> <td>SCREW M4X16 TCB+ INOX</td> <td>1</td> <td>PZ</td> </tr> <tr> <td>VI1075A0</td> <td>NUT M4 H=4 UNI5587 INOX</td> <td>1</td> <td>PZ</td> </tr> <tr> <td>VI1220A1</td> <td>4,2X12 TCB SELF-TAPPING SCREW</td> <td>6</td> <td>PZ</td> </tr> <tr> <td>VI1511A0</td> <td>STAINLESS STEEL WASHER 4.2X12X1</td> <td>1</td> <td>PZ</td> </tr> <tr> <td>VM1794A0</td> <td>250X4.8 PA66 BLACK CLAMP</td> <td>2</td> <td>PZ</td> </tr> <tr> <td>VM2103A0</td> <td>CLAMP LOCK</td> <td>2</td> <td>PZ</td> </tr> </tbody> </table> | Code                                | Description | Qty | UOM | GN1085A2 | 141X24 HEATING ELEMENT GASKET | 1 | PZ | RS1205A1 | 6 TURNS 5.6KW 230 HEATING ELEMENT | 1 | PZ | SL1045A0 | S53 BLACK SILICONE - 80ML CARTRIDGE | 1 | PZ | VI1032A0 | SCREW M4X16 TCB+ INOX | 1 | PZ | VI1075A0 | NUT M4 H=4 UNI5587 INOX | 1 | PZ | VI1220A1 | 4,2X12 TCB SELF-TAPPING SCREW | 6 | PZ | VI1511A0 | STAINLESS STEEL WASHER 4.2X12X1 | 1 | PZ | VM1794A0 | 250X4.8 PA66 BLACK CLAMP | 2 | PZ | VM2103A0 | CLAMP LOCK | 2 | PZ |
|           |                                    |   |            |                            | Code   | Description                         | Qty         | UOM |     |          |                               |   |    |          |                                   |   |    |          |                                     |   |    |          |                       |   |    |          |                         |   |    |          |                               |   |    |          |                                 |   |    |          |                          |   |    |          |            |   |    |
|           |                                    |   |            |                            | GN1085A2   | 141X24 HEATING ELEMENT GASKET       | 1           | PZ  |     |          |                               |   |    |          |                                   |   |    |          |                                     |   |    |          |                       |   |    |          |                         |   |    |          |                               |   |    |          |                                 |   |    |          |                          |   |    |          |            |   |    |
|           |                                    |   |            |                            | RS1205A1   | 6 TURNS 5.6KW 230 HEATING ELEMENT   | 1           | PZ  |     |          |                               |   |    |          |                                   |   |    |          |                                     |   |    |          |                       |   |    |          |                         |   |    |          |                               |   |    |          |                                 |   |    |          |                          |   |    |          |            |   |    |
|           |                                    |   |            |                            | SL1045A0   | S53 BLACK SILICONE - 80ML CARTRIDGE | 1           | PZ  |     |          |                               |   |    |          |                                   |   |    |          |                                     |   |    |          |                       |   |    |          |                         |   |    |          |                               |   |    |          |                                 |   |    |          |                          |   |    |          |            |   |    |
|           |                                    |   |            |                            | VI1032A0   | SCREW M4X16 TCB+ INOX               | 1           | PZ  |     |          |                               |   |    |          |                                   |   |    |          |                                     |   |    |          |                       |   |    |          |                         |   |    |          |                               |   |    |          |                                 |   |    |          |                          |   |    |          |            |   |    |
|           |                                    |   |            |                            | VI1075A0   | NUT M4 H=4 UNI5587 INOX             | 1           | PZ  |     |          |                               |   |    |          |                                   |   |    |          |                                     |   |    |          |                       |   |    |          |                         |   |    |          |                               |   |    |          |                                 |   |    |          |                          |   |    |          |            |   |    |
|           |                                    |   |            |                            | VI1220A1   | 4,2X12 TCB SELF-TAPPING SCREW       | 6           | PZ  |     |          |                               |   |    |          |                                   |   |    |          |                                     |   |    |          |                       |   |    |          |                         |   |    |          |                               |   |    |          |                                 |   |    |          |                          |   |    |          |            |   |    |
|           |                                    |   |            |                            | VI1511A0   | STAINLESS STEEL WASHER 4.2X12X1     | 1           | PZ  |     |          |                               |   |    |          |                                   |   |    |          |                                     |   |    |          |                       |   |    |          |                         |   |    |          |                               |   |    |          |                                 |   |    |          |                          |   |    |          |            |   |    |
|           |                                    |   |            |                            | VM1794A0   | 250X4.8 PA66 BLACK CLAMP            | 2           | PZ  |     |          |                               |   |    |          |                                   |   |    |          |                                     |   |    |          |                       |   |    |          |                         |   |    |          |                               |   |    |          |                                 |   |    |          |                          |   |    |          |            |   |    |
| VM2103A0  | CLAMP LOCK                         | 2   | PZ         |                            |  |                                     |             |     |     |          |                               |   |    |          |                                   |   |    |          |                                     |   |    |          |                       |   |    |          |                         |   |    |          |                               |   |    |          |                                 |   |    |          |                          |   |    |          |            |   |    |
| SN1016A   | 100MM CORE PROBE KIT L2750         |  | KSN1016A   | 100MM CORE PROBE KIT L2730 | <table border="1"> <thead> <tr> <th>Code</th> <th>Description</th> <th>Qty</th> <th>UOM</th> </tr> </thead> <tbody> <tr> <td>SN1016A1</td> <td>100MM CORE PROBE KIT L2750</td> <td>1</td> <td>PZ</td> </tr> </tbody> </table>  | Code                                | Description | Qty | UOM | SN1016A1 | 100MM CORE PROBE KIT L2750    | 1 | PZ |          |                                   |   |    |          |                                     |   |    |          |                       |   |    |          |                         |   |    |          |                               |   |    |          |                                 |   |    |          |                          |   |    |          |            |   |    |
| Code      | Description                        | Qty   | UOM        |                            |  |                                     |             |     |     |          |                               |   |    |          |                                   |   |    |          |                                     |   |    |          |                       |   |    |          |                         |   |    |          |                               |   |    |          |                                 |   |    |          |                          |   |    |          |            |   |    |
| SN1016A1  | 100MM CORE PROBE KIT L2750         | 1   | PZ         |                            |  |                                     |             |     |     |          |                               |   |    |          |                                   |   |    |          |                                     |   |    |          |                       |   |    |          |                         |   |    |          |                               |   |    |          |                                 |   |    |          |                          |   |    |          |            |   |    |
| 0H2730A   | ZINC PLATED MUFFLE SUPPORT BRACKET |  |            |                            |  |                                     |             |     |     |          |                               |   |    |          |                                   |   |    |          |                                     |   |    |          |                       |   |    |          |                         |   |    |          |                               |   |    |          |                                 |   |    |          |                          |   |    |          |            |   |    |

| COMPONENT |   |   | SPARE PART |                                   |  |      |             |     |     |          |   |    |    |
|-----------|---|---|------------|-----------------------------------|--|------|-------------|-----|-----|----------|---|----|----|
| Code      | Description                                   | Image   | Code       | Description                       | Components list  |      |             |     |     |          |   |    |    |
| GN1544A   | AIR INLET GASKET                              |    | GN1544A0   | AIR INLET GASKET                  |  |      |             |     |     |          |   |    |    |
| RC1055A   | Ø25-40 H12<br>STAINLESS STEEL<br>PIPE CLIP    |    | KRC1055A   | Ø25-40 PIPE CLAMP<br>10PCS KIT    | <table border="1"> <thead> <tr> <th>Code</th> <th>Description</th> <th>Qty</th> <th>UOM</th> </tr> </thead> <tbody> <tr> <td>RC1055A0</td> <td>Ø25-40 H12<br/>STAINLESS<br/>STEEL PIPE<br/>CLIP</td> <td>10</td> <td>PZ</td> </tr> </tbody> </table> | Code | Description | Qty | UOM | RC1055A0 | Ø25-40 H12<br>STAINLESS<br>STEEL PIPE<br>CLIP | 10 | PZ |
| Code      | Description                                   | Qty   | UOM        |                                   |  |      |             |     |     |          |   |    |    |
| RC1055A0  | Ø25-40 H12<br>STAINLESS<br>STEEL PIPE<br>CLIP | 10  | PZ         |                                   |  |      |             |     |     |          |   |    |    |
| TB3020A   | TB1520A-BLACK<br>EPDM PIPE L=275M             |  | TB3020A0   | TB1520A-BLACK<br>EPDM PIPE L=275M |  |      |             |     |     |          |   |    |    |
| TB3021A   | TB1520A-BLACK<br>EPDM PIPE L=448M             |  | TB3021A0   | TB1520A-BLACK<br>EPDM PIPE L=448M |  |      |             |     |     |          |   |    |    |
| TB3022A   | TB1520A-BLACK<br>EPDM PIPE L=140M             |  | TB3022A0   | TB1520A-BLACK<br>EPDM PIPE L=140M |  |      |             |     |     |          |   |    |    |

| COMPONENT |   |   | SPARE PART |  |   |      |             |     |     |          |                 |   |    |          |            |   |    |          |   |       |   |          |                                       |   |    |          |                          |   |    |          |                                      |   |    |          |                          |   |    |          |                          |   |    |          |                          |   |    |          |                          |   |    |          |                               |   |    |          |                               |   |    |          |                        |   |    |          |                        |   |    |          |                             |   |    |          |                             |   |    |
|-----------|---|---|------------|--|---|------|-------------|-----|-----|----------|-----------------|---|----|----------|------------|---|----|----------|---|-------|---|----------|---------------------------------------|---|----|----------|--------------------------|---|----|----------|--------------------------------------|---|----|----------|--------------------------|---|----|----------|--------------------------|---|----|----------|--------------------------|---|----|----------|--------------------------|---|----|----------|-------------------------------|---|----|----------|-------------------------------|---|----|----------|------------------------|---|----|----------|------------------------|---|----|----------|-----------------------------|---|----|----------|-----------------------------|---|----|
| Code      | Description                                     | Image   | Code       | Description                                | Components list   |      |             |     |     |          |                 |   |    |          |            |   |    |          |   |       |   |          |                                       |   |    |          |                          |   |    |          |                                      |   |    |          |                          |   |    |          |                          |   |    |          |                          |   |    |          |                          |   |    |          |                               |   |    |          |                               |   |    |          |                        |   |    |          |                        |   |    |          |                             |   |    |          |                             |   |    |
| TB3023A   | TB1520A-BLACK<br>EPDM PIPE L=230M               |  | TB3023A0   | TB1520A-BLACK<br>EPDM PIPE L=230M          |   |      |             |     |     |          |                 |   |    |          |            |   |    |          |   |       |   |          |                                       |   |    |          |                          |   |    |          |                                      |   |    |          |                          |   |    |          |                          |   |    |          |                          |   |    |          |                          |   |    |          |                               |   |    |          |                               |   |    |          |                        |   |    |          |                        |   |    |          |                             |   |    |          |                             |   |    |
| VM2377A   | 220 V 50/60 HZ<br>VENTURI KIT                   |  | KVM2377A   | MM 220 V VENTURI<br>ACTUATOR<br>SYSTEM KIT | <table border="1"> <thead> <tr> <th>Code</th> <th>Description</th> <th>Qty</th> <th>UOM</th> </tr> </thead> <tbody> <tr> <td>GN1556A0</td> <td>MM VENTURI SEAL</td> <td>1</td> <td>PZ</td> </tr> <tr> <td>RC1378A0</td> <td>HOSE CLAMP</td> <td>3</td> <td>PZ</td> </tr> <tr> <td>TB1520A0</td> <td>INT. Ø=38<br/>TH=4 DRAIN<br/>BLACK<br/>RUBBER PIPE</td> <td>0.170</td> <td>M</td> </tr> <tr> <td>VE1135A0</td> <td>220 V 50/60 HZ<br/>VENTURI<br/>ACTUATOR</td> <td>1</td> <td>PZ</td> </tr> <tr> <td>V11032A0</td> <td>SCREW M4X16<br/>TCB+ INOX</td> <td>1</td> <td>PZ</td> </tr> <tr> <td>V11220A1</td> <td>4,2X12 TCB<br/>SELF-TAPPIN<br/>G SCREW</td> <td>6</td> <td>PZ</td> </tr> <tr> <td>VM2345A0</td> <td>MM VENTURI<br/>UPPER HALF</td> <td>1</td> <td>PZ</td> </tr> <tr> <td>VM2345A0</td> <td>MM VENTURI<br/>UPPER HALF</td> <td>1</td> <td>PZ</td> </tr> <tr> <td>VM2346A0</td> <td>MM VENTURI<br/>LOWER HALF</td> <td>1</td> <td>PZ</td> </tr> <tr> <td>VM2346A0</td> <td>MM VENTURI<br/>LOWER HALF</td> <td>1</td> <td>PZ</td> </tr> <tr> <td>VM2347A0</td> <td>MIND.MAPS<br/>VENTURI<br/>COVER</td> <td>1</td> <td>PZ</td> </tr> <tr> <td>VM2347A0</td> <td>MIND.MAPS<br/>VENTURI<br/>COVER</td> <td>1</td> <td>PZ</td> </tr> <tr> <td>VM2348A0</td> <td>VENTURI<br/>PLATE SPACE</td> <td>1</td> <td>PZ</td> </tr> <tr> <td>VM2348A0</td> <td>VENTURI<br/>PLATE SPACE</td> <td>1</td> <td>PZ</td> </tr> <tr> <td>VM2349A0</td> <td>VENTURI<br/>LOWER<br/>BUSHING</td> <td>1</td> <td>PZ</td> </tr> <tr> <td>VM2349A0</td> <td>VENTURI<br/>LOWER<br/>BUSHING</td> <td>1</td> <td>PZ</td> </tr> </tbody> </table> | Code | Description | Qty | UOM | GN1556A0 | MM VENTURI SEAL | 1 | PZ | RC1378A0 | HOSE CLAMP | 3 | PZ | TB1520A0 | INT. Ø=38<br>TH=4 DRAIN<br>BLACK<br>RUBBER PIPE | 0.170 | M | VE1135A0 | 220 V 50/60 HZ<br>VENTURI<br>ACTUATOR | 1 | PZ | V11032A0 | SCREW M4X16<br>TCB+ INOX | 1 | PZ | V11220A1 | 4,2X12 TCB<br>SELF-TAPPIN<br>G SCREW | 6 | PZ | VM2345A0 | MM VENTURI<br>UPPER HALF | 1 | PZ | VM2345A0 | MM VENTURI<br>UPPER HALF | 1 | PZ | VM2346A0 | MM VENTURI<br>LOWER HALF | 1 | PZ | VM2346A0 | MM VENTURI<br>LOWER HALF | 1 | PZ | VM2347A0 | MIND.MAPS<br>VENTURI<br>COVER | 1 | PZ | VM2347A0 | MIND.MAPS<br>VENTURI<br>COVER | 1 | PZ | VM2348A0 | VENTURI<br>PLATE SPACE | 1 | PZ | VM2348A0 | VENTURI<br>PLATE SPACE | 1 | PZ | VM2349A0 | VENTURI<br>LOWER<br>BUSHING | 1 | PZ | VM2349A0 | VENTURI<br>LOWER<br>BUSHING | 1 | PZ |
| Code      | Description                                     | Qty   | UOM        |  |   |      |             |     |     |          |                 |   |    |          |            |   |    |          |   |       |   |          |                                       |   |    |          |                          |   |    |          |                                      |   |    |          |                          |   |    |          |                          |   |    |          |                          |   |    |          |                          |   |    |          |                               |   |    |          |                               |   |    |          |                        |   |    |          |                        |   |    |          |                             |   |    |          |                             |   |    |
| GN1556A0  | MM VENTURI SEAL                                 | 1   | PZ         |  |   |      |             |     |     |          |                 |   |    |          |            |   |    |          |   |       |   |          |                                       |   |    |          |                          |   |    |          |                                      |   |    |          |                          |   |    |          |                          |   |    |          |                          |   |    |          |                          |   |    |          |                               |   |    |          |                               |   |    |          |                        |   |    |          |                        |   |    |          |                             |   |    |          |                             |   |    |
| RC1378A0  | HOSE CLAMP                                      | 3   | PZ         |  |   |      |             |     |     |          |                 |   |    |          |            |   |    |          |   |       |   |          |                                       |   |    |          |                          |   |    |          |                                      |   |    |          |                          |   |    |          |                          |   |    |          |                          |   |    |          |                          |   |    |          |                               |   |    |          |                               |   |    |          |                        |   |    |          |                        |   |    |          |                             |   |    |          |                             |   |    |
| TB1520A0  | INT. Ø=38<br>TH=4 DRAIN<br>BLACK<br>RUBBER PIPE | 0.170   | M          |  |   |      |             |     |     |          |                 |   |    |          |            |   |    |          |   |       |   |          |                                       |   |    |          |                          |   |    |          |                                      |   |    |          |                          |   |    |          |                          |   |    |          |                          |   |    |          |                          |   |    |          |                               |   |    |          |                               |   |    |          |                        |   |    |          |                        |   |    |          |                             |   |    |          |                             |   |    |
| VE1135A0  | 220 V 50/60 HZ<br>VENTURI<br>ACTUATOR           | 1   | PZ         |  |   |      |             |     |     |          |                 |   |    |          |            |   |    |          |   |       |   |          |                                       |   |    |          |                          |   |    |          |                                      |   |    |          |                          |   |    |          |                          |   |    |          |                          |   |    |          |                          |   |    |          |                               |   |    |          |                               |   |    |          |                        |   |    |          |                        |   |    |          |                             |   |    |          |                             |   |    |
| V11032A0  | SCREW M4X16<br>TCB+ INOX                        | 1   | PZ         |  |   |      |             |     |     |          |                 |   |    |          |            |   |    |          |   |       |   |          |                                       |   |    |          |                          |   |    |          |                                      |   |    |          |                          |   |    |          |                          |   |    |          |                          |   |    |          |                          |   |    |          |                               |   |    |          |                               |   |    |          |                        |   |    |          |                        |   |    |          |                             |   |    |          |                             |   |    |
| V11220A1  | 4,2X12 TCB<br>SELF-TAPPIN<br>G SCREW            | 6   | PZ         |  |   |      |             |     |     |          |                 |   |    |          |            |   |    |          |   |       |   |          |                                       |   |    |          |                          |   |    |          |                                      |   |    |          |                          |   |    |          |                          |   |    |          |                          |   |    |          |                          |   |    |          |                               |   |    |          |                               |   |    |          |                        |   |    |          |                        |   |    |          |                             |   |    |          |                             |   |    |
| VM2345A0  | MM VENTURI<br>UPPER HALF                        | 1   | PZ         |  |   |      |             |     |     |          |                 |   |    |          |            |   |    |          |   |       |   |          |                                       |   |    |          |                          |   |    |          |                                      |   |    |          |                          |   |    |          |                          |   |    |          |                          |   |    |          |                          |   |    |          |                               |   |    |          |                               |   |    |          |                        |   |    |          |                        |   |    |          |                             |   |    |          |                             |   |    |
| VM2345A0  | MM VENTURI<br>UPPER HALF                        | 1   | PZ         |  |   |      |             |     |     |          |                 |   |    |          |            |   |    |          |   |       |   |          |                                       |   |    |          |                          |   |    |          |                                      |   |    |          |                          |   |    |          |                          |   |    |          |                          |   |    |          |                          |   |    |          |                               |   |    |          |                               |   |    |          |                        |   |    |          |                        |   |    |          |                             |   |    |          |                             |   |    |
| VM2346A0  | MM VENTURI<br>LOWER HALF                        | 1   | PZ         |  |   |      |             |     |     |          |                 |   |    |          |            |   |    |          |   |       |   |          |                                       |   |    |          |                          |   |    |          |                                      |   |    |          |                          |   |    |          |                          |   |    |          |                          |   |    |          |                          |   |    |          |                               |   |    |          |                               |   |    |          |                        |   |    |          |                        |   |    |          |                             |   |    |          |                             |   |    |
| VM2346A0  | MM VENTURI<br>LOWER HALF                        | 1   | PZ         |  |   |      |             |     |     |          |                 |   |    |          |            |   |    |          |   |       |   |          |                                       |   |    |          |                          |   |    |          |                                      |   |    |          |                          |   |    |          |                          |   |    |          |                          |   |    |          |                          |   |    |          |                               |   |    |          |                               |   |    |          |                        |   |    |          |                        |   |    |          |                             |   |    |          |                             |   |    |
| VM2347A0  | MIND.MAPS<br>VENTURI<br>COVER                   | 1   | PZ         |  |   |      |             |     |     |          |                 |   |    |          |            |   |    |          |   |       |   |          |                                       |   |    |          |                          |   |    |          |                                      |   |    |          |                          |   |    |          |                          |   |    |          |                          |   |    |          |                          |   |    |          |                               |   |    |          |                               |   |    |          |                        |   |    |          |                        |   |    |          |                             |   |    |          |                             |   |    |
| VM2347A0  | MIND.MAPS<br>VENTURI<br>COVER                   | 1   | PZ         |  |   |      |             |     |     |          |                 |   |    |          |            |   |    |          |   |       |   |          |                                       |   |    |          |                          |   |    |          |                                      |   |    |          |                          |   |    |          |                          |   |    |          |                          |   |    |          |                          |   |    |          |                               |   |    |          |                               |   |    |          |                        |   |    |          |                        |   |    |          |                             |   |    |          |                             |   |    |
| VM2348A0  | VENTURI<br>PLATE SPACE                          | 1   | PZ         |  |   |      |             |     |     |          |                 |   |    |          |            |   |    |          |   |       |   |          |                                       |   |    |          |                          |   |    |          |                                      |   |    |          |                          |   |    |          |                          |   |    |          |                          |   |    |          |                          |   |    |          |                               |   |    |          |                               |   |    |          |                        |   |    |          |                        |   |    |          |                             |   |    |          |                             |   |    |
| VM2348A0  | VENTURI<br>PLATE SPACE                          | 1   | PZ         |  |   |      |             |     |     |          |                 |   |    |          |            |   |    |          |   |       |   |          |                                       |   |    |          |                          |   |    |          |                                      |   |    |          |                          |   |    |          |                          |   |    |          |                          |   |    |          |                          |   |    |          |                               |   |    |          |                               |   |    |          |                        |   |    |          |                        |   |    |          |                             |   |    |          |                             |   |    |
| VM2349A0  | VENTURI<br>LOWER<br>BUSHING                     | 1   | PZ         |  |   |      |             |     |     |          |                 |   |    |          |            |   |    |          |   |       |   |          |                                       |   |    |          |                          |   |    |          |                                      |   |    |          |                          |   |    |          |                          |   |    |          |                          |   |    |          |                          |   |    |          |                               |   |    |          |                               |   |    |          |                        |   |    |          |                        |   |    |          |                             |   |    |          |                             |   |    |
| VM2349A0  | VENTURI<br>LOWER<br>BUSHING                     | 1   | PZ         |  |   |      |             |     |     |          |                 |   |    |          |            |   |    |          |   |       |   |          |                                       |   |    |          |                          |   |    |          |                                      |   |    |          |                          |   |    |          |                          |   |    |          |                          |   |    |          |                          |   |    |          |                               |   |    |          |                               |   |    |          |                        |   |    |          |                        |   |    |          |                             |   |    |          |                             |   |    |

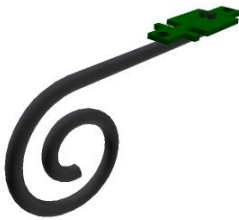

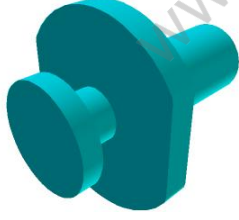

| COMPONENT |  |  | SPARE PART |  |   |      |             |  |     |          |                              |  |    |          |  |                       |       |   |
|-----------|--|--|------------|--|---|------|-------------|--|-----|----------|------------------------------|--|----|----------|--|-----------------------|-------|---|
| Code      | Description                            | Image  | Code       | Description                            | Components list   |      |             |  |     |          |                              |  |    |          |  |                       |       |   |
| GN1584A   | CORNER FITTING<br>D30-D16              |   | KG1584A    | D30-D16 CORNER FITTING KIT             | <table border="1"> <thead> <tr> <th>Code</th> <th>Description</th> <th>Qty</th> <th>UOM</th> </tr> </thead> <tbody> <tr> <td>GN1584A0</td> <td>CORNER FITTING D30-D16</td> <td>1</td> <td>PZ</td> </tr> </tbody> </table>   | Code | Description | Qty                                    | UOM | GN1584A0 | CORNER FITTING D30-D16       | 1                                      | PZ |          |  |                       |       |   |
| Code      | Description                            | Qty  | UOM        |  |   |      |             |  |     |          |                              |  |    |          |  |                       |       |   |
| GN1584A0  | CORNER FITTING D30-D16                 | 1  | PZ         |  |   |      |             |  |     |          |                              |  |    |          |  |                       |       |   |
| TB1956A   | TB1520A-GREY SILICONE PIPE<br>L=0,04M  |   | KT1002A    | BLACK TUBE KIT<br>EPDM 60MT TB1520     | <table border="1"> <thead> <tr> <th>Code</th> <th>Description</th> <th>Qty</th> <th>UOM</th> </tr> </thead> <tbody> <tr> <td>IL1206C0</td> <td>968X1053 H126 XBC WOOD PALLE</td> <td>1</td> <td>PZ</td> </tr> <tr> <td>TB1520A0</td> <td>INT. Ø=38 TH=4 DRAIN BLACK RUBBER PIPE</td> <td>60</td> <td>M</td> </tr> </tbody> </table> | Code | Description | Qty                                    | UOM | IL1206C0 | 968X1053 H126 XBC WOOD PALLE | 1                                      | PZ | TB1520A0 | INT. Ø=38 TH=4 DRAIN BLACK RUBBER PIPE | 60                    | M     |   |
|           |  |  | Code       | Description                            | Qty   | UOM  |             |  |     |          |                              |  |    |          |  |                       |       |   |
|           |  |  | IL1206C0   | 968X1053 H126 XBC WOOD PALLE           | 1   | PZ   |             |  |     |          |                              |  |    |          |  |                       |       |   |
| TB1520A0  | INT. Ø=38 TH=4 DRAIN BLACK RUBBER PIPE | 60   | M          |  |   |      |             |  |     |          |                              |  |    |          |  |                       |       |   |
| KT1001A   | BLACK TUBE KIT<br>EPDM 10MT TB1520     | <table border="1"> <thead> <tr> <th>Code</th> <th>Description</th> <th>Qty</th> <th>UOM</th> </tr> </thead> <tbody> <tr> <td>TB1520A0</td> <td>INT. Ø=38 TH=4 DRAIN BLACK RUBBER PIPE</td> <td>10</td> <td>M</td> </tr> <tr> <td>VM1794A0</td> <td>250X4.8 PA66 BLACK CLAMP</td> <td>3</td> <td>PZ</td> </tr> </tbody> </table>  | Code       | Description                            | Qty   | UOM  | TB1520A0    | INT. Ø=38 TH=4 DRAIN BLACK RUBBER PIPE | 10  | M        | VM1794A0                     | 250X4.8 PA66 BLACK CLAMP               | 3  | PZ       |  |                       |       |   |
| Code      | Description                            | Qty  | UOM        |  |   |      |             |  |     |          |                              |  |    |          |  |                       |       |   |
| TB1520A0  | INT. Ø=38 TH=4 DRAIN BLACK RUBBER PIPE | 10   | M          |  |   |      |             |  |     |          |                              |  |    |          |  |                       |       |   |
| VM1794A0  | 250X4.8 PA66 BLACK CLAMP               | 3  | PZ         |  |   |      |             |  |     |          |                              |  |    |          |  |                       |       |   |
| KT1000A   | BLACK TUBE KIT<br>EPDM 2MT TB1520A     | <table border="1"> <thead> <tr> <th>Code</th> <th>Description</th> <th>Qty</th> <th>UOM</th> </tr> </thead> <tbody> <tr> <td>RC1055A0</td> <td>Ø25-40 H12 STAINLESS STEEL PIPE CLIP</td> <td>2</td> <td>PZ</td> </tr> <tr> <td>TB1520A0</td> <td>INT. Ø=38 TH=4 DRAIN BLACK RUBBER PIPE</td> <td>2</td> <td>M</td> </tr> <tr> <td>VM1059A1</td> <td>HEAT SHRINK FILM H800</td> <td>1.500</td> <td>M</td> </tr> </tbody> </table> | Code       | Description                            | Qty   | UOM  | RC1055A0    | Ø25-40 H12 STAINLESS STEEL PIPE CLIP   | 2   | PZ       | TB1520A0                     | INT. Ø=38 TH=4 DRAIN BLACK RUBBER PIPE | 2  | M        | VM1059A1                               | HEAT SHRINK FILM H800 | 1.500 | M |
| Code      | Description                            | Qty  | UOM        |  |   |      |             |  |     |          |                              |  |    |          |  |                       |       |   |
| RC1055A0  | Ø25-40 H12 STAINLESS STEEL PIPE CLIP   | 2  | PZ         |  |   |      |             |  |     |          |                              |  |    |          |  |                       |       |   |
| TB1520A0  | INT. Ø=38 TH=4 DRAIN BLACK RUBBER PIPE | 2  | M          |  |   |      |             |  |     |          |                              |  |    |          |  |                       |       |   |
| VM1059A1  | HEAT SHRINK FILM H800                  | 1.500  | M          |  |   |      |             |  |     |          |                              |  |    |          |  |                       |       |   |
| RC1042A   | DOUBLE WIRE SPRING CLAMP<br>D21.5-22.6 |   | RC1042A0   | DOUBLE WIRE SPRING CLAMP<br>D21.5-22.6 |   |      |             |  |     |          |                              |  |    |          |  |                       |       |   |

| COMPONENT |   |   | SPARE PART |  |   |      |             |     |     |          |   |   |    |          |                               |   |    |          |                            |   |    |          |                       |   |    |
|-----------|---|---|------------|--|---|------|-------------|-----|-----|----------|---|---|----|----------|-------------------------------|---|----|----------|----------------------------|---|----|----------|-----------------------|---|----|
| Code      | Description                                       | Image   | Code       | Description                              | Components list   |      |             |     |     |          |   |   |    |          |                               |   |    |          |                            |   |    |          |                       |   |    |
| PE1710B   | MOTOR<br>REVOLUTION AND<br>DIRECTION SENSO        |    | KPE1710B   | MOTOR<br>REVOLUTIONS<br>SENSOR KIT       | <table border="1"> <thead> <tr> <th>Code</th> <th>Description</th> <th>Qty</th> <th>UOM</th> </tr> </thead> <tbody> <tr> <td>PE1710B0</td> <td>MOTOR<br/>REVOLUTION<br/>AND<br/>DIRECTION<br/>SENSOR</td> <td>1</td> <td>PZ</td> </tr> <tr> <td>VE1550A0</td> <td>5X3 MM<br/>NEODYMIUM<br/>MAGNET</td> <td>1</td> <td>PZ</td> </tr> <tr> <td>VI1966A0</td> <td>M4X14<br/>FLATHEAD<br/>SCREW</td> <td>1</td> <td>PZ</td> </tr> <tr> <td>VM1635A0</td> <td>MAGNET<br/>HOLDING DIS</td> <td>1</td> <td>PZ</td> </tr> </tbody> </table> | Code | Description | Qty | UOM | PE1710B0 | MOTOR<br>REVOLUTION<br>AND<br>DIRECTION<br>SENSOR | 1 | PZ | VE1550A0 | 5X3 MM<br>NEODYMIUM<br>MAGNET | 1 | PZ | VI1966A0 | M4X14<br>FLATHEAD<br>SCREW | 1 | PZ | VM1635A0 | MAGNET<br>HOLDING DIS | 1 | PZ |
| Code      | Description                                       | Qty   | UOM        |  |   |      |             |     |     |          |   |   |    |          |                               |   |    |          |                            |   |    |          |                       |   |    |
| PE1710B0  | MOTOR<br>REVOLUTION<br>AND<br>DIRECTION<br>SENSOR | 1   | PZ         |  |   |      |             |     |     |          |   |   |    |          |                               |   |    |          |                            |   |    |          |                       |   |    |
| VE1550A0  | 5X3 MM<br>NEODYMIUM<br>MAGNET                     | 1   | PZ         |  |   |      |             |     |     |          |   |   |    |          |                               |   |    |          |                            |   |    |          |                       |   |    |
| VI1966A0  | M4X14<br>FLATHEAD<br>SCREW                        | 1   | PZ         |  |   |      |             |     |     |          |   |   |    |          |                               |   |    |          |                            |   |    |          |                       |   |    |
| VM1635A0  | MAGNET<br>HOLDING DIS                             | 1   | PZ         |  |   |      |             |     |     |          |   |   |    |          |                               |   |    |          |                            |   |    |          |                       |   |    |
| VE1550A   | 5X3 MM<br>NEODYMIUM<br>MAGNET                     |   | VE1550A0   | 5X3 MM<br>NEODYMIUM<br>MAGNET            |   |      |             |     |     |          |   |   |    |          |                               |   |    |          |                            |   |    |          |                       |   |    |
| GN1588A   | 78X28 G6.25<br>HEATING ELEMENT<br>GASKET          |  | GN1588A0   | 78X28 G6.25<br>HEATING ELEMENT<br>GASKET |   |      |             |     |     |          |   |   |    |          |                               |   |    |          |                            |   |    |          |                       |   |    |
| VM2416A   | SMOKER BLOCKING<br>GUIDE PIN                      |  | VM2416A0   | SMOKER BLOCKING<br>GUIDE PIN             |   |      |             |     |     |          |   |   |    |          |                               |   |    |          |                            |   |    |          |                       |   |    |
| MT1012A   | 330W 230V MOTOR                                   |  | KMT1012A   | MIND.MAPS 330W<br>230V MOTOR KIT         | <table border="1"> <thead> <tr> <th>Code</th> <th>Description</th> <th>Qty</th> <th>UOM</th> </tr> </thead> <tbody> <tr> <td>0H4305A1</td> <td>ST. STEEL<br/>MOTOR<br/>SHAFT<br/>SEALING DISC</td> <td>1</td> <td>PZ</td> </tr> <tr> <td>GN1140A2</td> <td>MOTOR<br/>HOLDER<br/>GASKET</td> <td>1</td> <td>PZ</td> </tr> <tr> <td>MT1012A0</td> <td>330W 230V<br/>MOTOR</td> <td>1</td> <td>PZ</td> </tr> </tbody> </table>   | Code | Description | Qty | UOM | 0H4305A1 | ST. STEEL<br>MOTOR<br>SHAFT<br>SEALING DISC       | 1 | PZ | GN1140A2 | MOTOR<br>HOLDER<br>GASKET     | 1 | PZ | MT1012A0 | 330W 230V<br>MOTOR         | 1 | PZ |          |                       |   |    |
| Code      | Description                                       | Qty   | UOM        |  |   |      |             |     |     |          |   |   |    |          |                               |   |    |          |                            |   |    |          |                       |   |    |
| 0H4305A1  | ST. STEEL<br>MOTOR<br>SHAFT<br>SEALING DISC       | 1   | PZ         |  |   |      |             |     |     |          |   |   |    |          |                               |   |    |          |                            |   |    |          |                       |   |    |
| GN1140A2  | MOTOR<br>HOLDER<br>GASKET                         | 1   | PZ         |  |   |      |             |     |     |          |   |   |    |          |                               |   |    |          |                            |   |    |          |                       |   |    |
| MT1012A0  | 330W 230V<br>MOTOR                                | 1   | PZ         |  |   |      |             |     |     |          |   |   |    |          |                               |   |    |          |                            |   |    |          |                       |   |    |

| COMPONENT |                                     |   | SPARE PART |                                  |  |      |             |     |     |          |                                    |   |    |          |                     |   |    |          |                                     |   |    |          |                                |   |    |          |                    |   |    |          |                          |   |    |          |            |   |    |
|-----------|-------------------------------------|---|------------|----------------------------------|--|------|-------------|-----|-----|----------|------------------------------------|---|----|----------|---------------------|---|----|----------|-------------------------------------|---|----|----------|--------------------------------|---|----|----------|--------------------|---|----|----------|--------------------------|---|----|----------|------------|---|----|
| Code      | Description                         | Image   | Code       | Description                      | Components list  |      |             |     |     |          |                                    |   |    |          |                     |   |    |          |                                     |   |    |          |                                |   |    |          |                    |   |    |          |                          |   |    |          |            |   |    |
| MT1012A   | 330W 230V MOTOR                     |    | KMT1012A   | MIND.MAPS 330W 230V MOTOR KIT    | <table border="1"> <thead> <tr> <th>Code</th> <th>Description</th> <th>Qty</th> <th>UOM</th> </tr> </thead> <tbody> <tr> <td>VE1550A0</td> <td>5X3 MM NEODYMIUM MAGNET</td> <td>1</td> <td>PZ</td> </tr> <tr> <td>VI1077A1</td> <td>SCREW M6X12 TE INOX</td> <td>1</td> <td>PZ</td> </tr> <tr> <td>VI1521A0</td> <td>STAINLESS STEEL WASHER D=6 6592</td> <td>1</td> <td>PZ</td> </tr> <tr> <td>VI1966A0</td> <td>M4X14 FLATHEAD SCREW</td> <td>1</td> <td>PZ</td> </tr> <tr> <td>VM1635A0</td> <td>MAGNET HOLDING DIS</td> <td>1</td> <td>PZ</td> </tr> <tr> <td>VM1794A0</td> <td>250X4.8 PA66 BLACK CLAMP</td> <td>4</td> <td>PZ</td> </tr> <tr> <td>VM2103A0</td> <td>CLAMP LOCK</td> <td>4</td> <td>PZ</td> </tr> </tbody> </table> | Code | Description | Qty | UOM | VE1550A0 | 5X3 MM NEODYMIUM MAGNET            | 1 | PZ | VI1077A1 | SCREW M6X12 TE INOX | 1 | PZ | VI1521A0 | STAINLESS STEEL WASHER D=6 6592     | 1 | PZ | VI1966A0 | M4X14 FLATHEAD SCREW           | 1 | PZ | VM1635A0 | MAGNET HOLDING DIS | 1 | PZ | VM1794A0 | 250X4.8 PA66 BLACK CLAMP | 4 | PZ | VM2103A0 | CLAMP LOCK | 4 | PZ |
| Code      | Description                         | Qty   | UOM        |                                  |  |      |             |     |     |          |                                    |   |    |          |                     |   |    |          |                                     |   |    |          |                                |   |    |          |                    |   |    |          |                          |   |    |          |            |   |    |
| VE1550A0  | 5X3 MM NEODYMIUM MAGNET             | 1   | PZ         |                                  |  |      |             |     |     |          |                                    |   |    |          |                     |   |    |          |                                     |   |    |          |                                |   |    |          |                    |   |    |          |                          |   |    |          |            |   |    |
| VI1077A1  | SCREW M6X12 TE INOX                 | 1   | PZ         |                                  |  |      |             |     |     |          |                                    |   |    |          |                     |   |    |          |                                     |   |    |          |                                |   |    |          |                    |   |    |          |                          |   |    |          |            |   |    |
| VI1521A0  | STAINLESS STEEL WASHER D=6 6592     | 1   | PZ         |                                  |  |      |             |     |     |          |                                    |   |    |          |                     |   |    |          |                                     |   |    |          |                                |   |    |          |                    |   |    |          |                          |   |    |          |            |   |    |
| VI1966A0  | M4X14 FLATHEAD SCREW                | 1   | PZ         |                                  |  |      |             |     |     |          |                                    |   |    |          |                     |   |    |          |                                     |   |    |          |                                |   |    |          |                    |   |    |          |                          |   |    |          |            |   |    |
| VM1635A0  | MAGNET HOLDING DIS                  | 1   | PZ         |                                  |  |      |             |     |     |          |                                    |   |    |          |                     |   |    |          |                                     |   |    |          |                                |   |    |          |                    |   |    |          |                          |   |    |          |            |   |    |
| VM1794A0  | 250X4.8 PA66 BLACK CLAMP            | 4   | PZ         |                                  |  |      |             |     |     |          |                                    |   |    |          |                     |   |    |          |                                     |   |    |          |                                |   |    |          |                    |   |    |          |                          |   |    |          |            |   |    |
| VM2103A0  | CLAMP LOCK                          | 4   | PZ         |                                  |  |      |             |     |     |          |                                    |   |    |          |                     |   |    |          |                                     |   |    |          |                                |   |    |          |                    |   |    |          |                          |   |    |          |            |   |    |
| 0H7170A   | MM MOTOR GLASS WOOL PLATE           |  | 0H7170A0   | MM MOTOR GLASS WOOL PLATE        |  |      |             |     |     |          |                                    |   |    |          |                     |   |    |          |                                     |   |    |          |                                |   |    |          |                    |   |    |          |                          |   |    |          |            |   |    |
| GN1140A   | MOTOR HOLDER GASKET                 |  | KGN1140A   | 5 PCS. MOTOR HOLDER GASKET KI    | <table border="1"> <thead> <tr> <th>Code</th> <th>Description</th> <th>Qty</th> <th>UOM</th> </tr> </thead> <tbody> <tr> <td>GN1140A2</td> <td>MOTOR HOLDER GASKET</td> <td>5</td> <td>PZ</td> </tr> </tbody> </table>   | Code | Description | Qty | UOM | GN1140A2 | MOTOR HOLDER GASKET                | 5 | PZ |          |                     |   |    |          |                                     |   |    |          |                                |   |    |          |                    |   |    |          |                          |   |    |          |            |   |    |
| Code      | Description                         | Qty   | UOM        |                                  |  |      |             |     |     |          |                                    |   |    |          |                     |   |    |          |                                     |   |    |          |                                |   |    |          |                    |   |    |          |                          |   |    |          |            |   |    |
| GN1140A2  | MOTOR HOLDER GASKET                 | 5   | PZ         |                                  |  |      |             |     |     |          |                                    |   |    |          |                     |   |    |          |                                     |   |    |          |                                |   |    |          |                    |   |    |          |                          |   |    |          |            |   |    |
| 0H4305A   | ST. STEEL MOTOR SHAFT SEALING DIS   |  | K0H4305A   | SEALING DISC FOR MOTOR SHAFT KIT | <table border="1"> <thead> <tr> <th>Code</th> <th>Description</th> <th>Qty</th> <th>UOM</th> </tr> </thead> <tbody> <tr> <td>0H4305A1</td> <td>ST. STEEL MOTOR SHAFT SEALING DISC</td> <td>1</td> <td>PZ</td> </tr> <tr> <td>GN1140A2</td> <td>MOTOR HOLDER GASKET</td> <td>1</td> <td>PZ</td> </tr> <tr> <td>SL1045A0</td> <td>S53 BLACK SILICONE - 80ML CARTRIDGE</td> <td>1</td> <td>PZ</td> </tr> <tr> <td>VI1220A1</td> <td>4,2X12 TCB SELF-TAPPIN G SCREW</td> <td>3</td> <td>PZ</td> </tr> </tbody> </table>  | Code | Description | Qty | UOM | 0H4305A1 | ST. STEEL MOTOR SHAFT SEALING DISC | 1 | PZ | GN1140A2 | MOTOR HOLDER GASKET | 1 | PZ | SL1045A0 | S53 BLACK SILICONE - 80ML CARTRIDGE | 1 | PZ | VI1220A1 | 4,2X12 TCB SELF-TAPPIN G SCREW | 3 | PZ |          |                    |   |    |          |                          |   |    |          |            |   |    |
| Code      | Description                         | Qty   | UOM        |                                  |  |      |             |     |     |          |                                    |   |    |          |                     |   |    |          |                                     |   |    |          |                                |   |    |          |                    |   |    |          |                          |   |    |          |            |   |    |
| 0H4305A1  | ST. STEEL MOTOR SHAFT SEALING DISC  | 1   | PZ         |                                  |  |      |             |     |     |          |                                    |   |    |          |                     |   |    |          |                                     |   |    |          |                                |   |    |          |                    |   |    |          |                          |   |    |          |            |   |    |
| GN1140A2  | MOTOR HOLDER GASKET                 | 1   | PZ         |                                  |  |      |             |     |     |          |                                    |   |    |          |                     |   |    |          |                                     |   |    |          |                                |   |    |          |                    |   |    |          |                          |   |    |          |            |   |    |
| SL1045A0  | S53 BLACK SILICONE - 80ML CARTRIDGE | 1   | PZ         |                                  |  |      |             |     |     |          |                                    |   |    |          |                     |   |    |          |                                     |   |    |          |                                |   |    |          |                    |   |    |          |                          |   |    |          |            |   |    |
| VI1220A1  | 4,2X12 TCB SELF-TAPPIN G SCREW      | 3   | PZ         |                                  |  |      |             |     |     |          |                                    |   |    |          |                     |   |    |          |                                     |   |    |          |                                |   |    |          |                    |   |    |          |                          |   |    |          |            |   |    |

| COMPONENT |   |   | SPARE PART |   |  |             |             |     |     |          |  |    |    |          |  |       |    |          |                                     |       |    |          |                                     |       |    |          |   |   |    |
|-----------|---|---|------------|---|--|-------------|-------------|-----|-----|----------|--|----|----|----------|--|-------|----|----------|-------------------------------------|-------|----|----------|-------------------------------------|-------|----|----------|---|---|----|
| Code      | Description                                   | Image   | Code       | Description                                   | Components list  |             |             |     |     |          |  |    |    |          |  |       |    |          |                                     |       |    |          |                                     |       |    |          |   |   |    |
| VN1170B   | D195 H80 8 BLADES<br>FAN+RING                 |    | KVN1170B   | D195 H80 8 BLADES<br>FAN + RING KIT           | <table border="1"> <thead> <tr> <th>Code</th> <th>Description</th> <th>Qty</th> <th>UOM</th> </tr> </thead> <tbody> <tr> <td>VI1077A1</td> <td>SCREW M6X12<br/>TE INOX</td> <td>1</td> <td>PZ</td> </tr> <tr> <td>VI1521A0</td> <td>STAINLESS<br/>STEEL<br/>WASHER D=6<br/>6592</td> <td>1</td> <td>PZ</td> </tr> <tr> <td>VN1170B0</td> <td>D195 H80 8<br/>BLADES<br/>FAN+RING</td> <td>1</td> <td>PZ</td> </tr> <tr> <td>VN1170B0</td> <td>D195 H80 8<br/>BLADES<br/>FAN+RING</td> <td>1</td> <td>PZ</td> </tr> </tbody> </table>  | Code        | Description | Qty | UOM | VI1077A1 | SCREW M6X12<br>TE INOX                 | 1  | PZ | VI1521A0 | STAINLESS<br>STEEL<br>WASHER D=6<br>6592 | 1     | PZ | VN1170B0 | D195 H80 8<br>BLADES<br>FAN+RING    | 1     | PZ | VN1170B0 | D195 H80 8<br>BLADES<br>FAN+RING    | 1     | PZ |          |   |   |    |
|           |   |   |            |   | Code   | Description | Qty         | UOM |     |          |  |    |    |          |  |       |    |          |                                     |       |    |          |                                     |       |    |          |   |   |    |
| VI1077A1  | SCREW M6X12<br>TE INOX                        | 1   | PZ         |   |  |             |             |     |     |          |  |    |    |          |  |       |    |          |                                     |       |    |          |                                     |       |    |          |   |   |    |
| VI1521A0  | STAINLESS<br>STEEL<br>WASHER D=6<br>6592      | 1   | PZ         |   |  |             |             |     |     |          |  |    |    |          |  |       |    |          |                                     |       |    |          |                                     |       |    |          |   |   |    |
| VN1170B0  | D195 H80 8<br>BLADES<br>FAN+RING              | 1   | PZ         |   |  |             |             |     |     |          |  |    |    |          |  |       |    |          |                                     |       |    |          |                                     |       |    |          |   |   |    |
| VN1170B0  | D195 H80 8<br>BLADES<br>FAN+RING              | 1   | PZ         |   |  |             |             |     |     |          |  |    |    |          |  |       |    |          |                                     |       |    |          |                                     |       |    |          |   |   |    |
| GN1555A   |   |   | KGN1555B   | 16EU/2011/2021<br>DOOR GASKET KIT             | <table border="1"> <thead> <tr> <th>Code</th> <th>Description</th> <th>Qty</th> <th>UOM</th> </tr> </thead> <tbody> <tr> <td>0H1604A0</td> <td></td> <td>2</td> <td>PZ</td> </tr> <tr> <td>GN1006A1</td> <td>DOOR GASKE</td> <td>4.190</td> <td>M</td> </tr> <tr> <td>GN1008A0</td> <td>DOOR SEAL<br/>INTERNAL<br/>CONNECTION</td> <td>0.030</td> <td>M</td> </tr> <tr> <td>SL1025A0</td> <td>CLEAR<br/>SILICON DOW<br/>CORNING 734</td> <td>0.010</td> <td>PZ</td> </tr> <tr> <td>VM2277A0</td> <td>DOOR SEAL<br/>KIT INTERNAL<br/>CONNECTION</td> <td>1</td> <td>PZ</td> </tr> </tbody> </table> | Code        | Description | Qty | UOM | 0H1604A0 |  | 2  | PZ | GN1006A1 | DOOR GASKE                               | 4.190 | M  | GN1008A0 | DOOR SEAL<br>INTERNAL<br>CONNECTION | 0.030 | M  | SL1025A0 | CLEAR<br>SILICON DOW<br>CORNING 734 | 0.010 | PZ | VM2277A0 | DOOR SEAL<br>KIT INTERNAL<br>CONNECTION | 1 | PZ |
| Code      | Description                                   | Qty   | UOM        |   |  |             |             |     |     |          |  |    |    |          |  |       |    |          |                                     |       |    |          |                                     |       |    |          |   |   |    |
| 0H1604A0  |   | 2   | PZ         |   |  |             |             |     |     |          |  |    |    |          |  |       |    |          |                                     |       |    |          |                                     |       |    |          |   |   |    |
| GN1006A1  | DOOR GASKE                                    | 4.190   | M          |   |  |             |             |     |     |          |  |    |    |          |  |       |    |          |                                     |       |    |          |                                     |       |    |          |   |   |    |
| GN1008A0  | DOOR SEAL<br>INTERNAL<br>CONNECTION           | 0.030   | M          |   |  |             |             |     |     |          |  |    |    |          |  |       |    |          |                                     |       |    |          |                                     |       |    |          |   |   |    |
| SL1025A0  | CLEAR<br>SILICON DOW<br>CORNING 734           | 0.010   | PZ         |   |  |             |             |     |     |          |  |    |    |          |  |       |    |          |                                     |       |    |          |                                     |       |    |          |   |   |    |
| VM2277A0  | DOOR SEAL<br>KIT INTERNAL<br>CONNECTION       | 1   | PZ         |   |  |             |             |     |     |          |  |    |    |          |  |       |    |          |                                     |       |    |          |                                     |       |    |          |   |   |    |
| RC1170A   | STAINLESS STEEL<br>NUT M14 H=8 CH=22          |  | KRC1170A   | M14 H8 CH22 NUT -<br>10 PCS. KIT              | <table border="1"> <thead> <tr> <th>Code</th> <th>Description</th> <th>Qty</th> <th>UOM</th> </tr> </thead> <tbody> <tr> <td>RC1170A1</td> <td>STAINLESS<br/>STEEL NUT<br/>M14 H=8 CH=2</td> <td>10</td> <td>PZ</td> </tr> </tbody> </table>   | Code        | Description | Qty | UOM | RC1170A1 | STAINLESS<br>STEEL NUT<br>M14 H=8 CH=2 | 10 | PZ |          |  |       |    |          |                                     |       |    |          |                                     |       |    |          |   |   |    |
| Code      | Description                                   | Qty   | UOM        |   |  |             |             |     |     |          |  |    |    |          |  |       |    |          |                                     |       |    |          |                                     |       |    |          |   |   |    |
| RC1170A1  | STAINLESS<br>STEEL NUT<br>M14 H=8 CH=2        | 10  | PZ         |   |  |             |             |     |     |          |  |    |    |          |  |       |    |          |                                     |       |    |          |                                     |       |    |          |   |   |    |
| TB2937B   | XEBC EXTERNAL<br>WATER PIPE<br>D10+CONNECTION |  | TB2937B0   | XEBC EXTERNAL<br>WATER PIPE<br>D10+CONNECTION |  |             |             |     |     |          |  |    |    |          |  |       |    |          |                                     |       |    |          |                                     |       |    |          |   |   |    |

| COMPONENT |                                |   | SPARE PART |                          |  |      |             |     |     |          |                              |   |    |          |                            |   |    |          |                           |   |    |          |                            |   |    |          |                            |   |    |          |                                |   |    |          |                      |   |    |          |                           |   |    |          |             |   |    |
|-----------|--------------------------------|---|------------|--------------------------|--|------|-------------|-----|-----|----------|------------------------------|---|----|----------|----------------------------|---|----|----------|---------------------------|---|----|----------|----------------------------|---|----|----------|----------------------------|---|----|----------|--------------------------------|---|----|----------|----------------------|---|----|----------|---------------------------|---|----|----------|-------------|---|----|
| Code      | Description                    | Image   | Code       | Description              | Components list  |      |             |     |     |          |                              |   |    |          |                            |   |    |          |                           |   |    |          |                            |   |    |          |                            |   |    |          |                                |   |    |          |                      |   |    |          |                           |   |    |          |             |   |    |
| VL1037A   | WASHING SYSTEM ROTOR           |    | KVL1037A   | WASHING SYSTEM ROTOR KIT | <table border="1"> <thead> <tr> <th>Code</th> <th>Description</th> <th>Qty</th> <th>UOM</th> </tr> </thead> <tbody> <tr> <td>GN1416B0</td> <td>WASHING SYSTEM ROTOR BEARING</td> <td>1</td> <td>PZ</td> </tr> <tr> <td>TF1065B0</td> <td>WASHING SYSTEM ROTOR PIVOT</td> <td>1</td> <td>PZ</td> </tr> <tr> <td>TF1066A1</td> <td>WASHING SYSTEM ROTOR BUSH</td> <td>1</td> <td>PZ</td> </tr> <tr> <td>UG1005B1</td> <td>LONG RAY ROTOR WATER NOZZL</td> <td>1</td> <td>PZ</td> </tr> <tr> <td>UG1006B3</td> <td>LONG RAY ROTOR WATER NOZZL</td> <td>1</td> <td>PZ</td> </tr> <tr> <td>VI1220A1</td> <td>4,2X12 TCB SELF-TAPPIN G SCREW</td> <td>8</td> <td>PZ</td> </tr> <tr> <td>VM1955C0</td> <td>WASHING SYSTEM ROTOR</td> <td>1</td> <td>PZ</td> </tr> <tr> <td>VM1985C1</td> <td>WASHING SYSTEM ROTOR COVE</td> <td>1</td> <td>PZ</td> </tr> <tr> <td>VM1986A0</td> <td>NOZZLE COVE</td> <td>2</td> <td>PZ</td> </tr> </tbody> </table> | Code | Description | Qty | UOM | GN1416B0 | WASHING SYSTEM ROTOR BEARING | 1 | PZ | TF1065B0 | WASHING SYSTEM ROTOR PIVOT | 1 | PZ | TF1066A1 | WASHING SYSTEM ROTOR BUSH | 1 | PZ | UG1005B1 | LONG RAY ROTOR WATER NOZZL | 1 | PZ | UG1006B3 | LONG RAY ROTOR WATER NOZZL | 1 | PZ | VI1220A1 | 4,2X12 TCB SELF-TAPPIN G SCREW | 8 | PZ | VM1955C0 | WASHING SYSTEM ROTOR | 1 | PZ | VM1985C1 | WASHING SYSTEM ROTOR COVE | 1 | PZ | VM1986A0 | NOZZLE COVE | 2 | PZ |
| Code      | Description                    | Qty   | UOM        |                          |  |      |             |     |     |          |                              |   |    |          |                            |   |    |          |                           |   |    |          |                            |   |    |          |                            |   |    |          |                                |   |    |          |                      |   |    |          |                           |   |    |          |             |   |    |
| GN1416B0  | WASHING SYSTEM ROTOR BEARING   | 1   | PZ         |                          |  |      |             |     |     |          |                              |   |    |          |                            |   |    |          |                           |   |    |          |                            |   |    |          |                            |   |    |          |                                |   |    |          |                      |   |    |          |                           |   |    |          |             |   |    |
| TF1065B0  | WASHING SYSTEM ROTOR PIVOT     | 1   | PZ         |                          |  |      |             |     |     |          |                              |   |    |          |                            |   |    |          |                           |   |    |          |                            |   |    |          |                            |   |    |          |                                |   |    |          |                      |   |    |          |                           |   |    |          |             |   |    |
| TF1066A1  | WASHING SYSTEM ROTOR BUSH      | 1   | PZ         |                          |  |      |             |     |     |          |                              |   |    |          |                            |   |    |          |                           |   |    |          |                            |   |    |          |                            |   |    |          |                                |   |    |          |                      |   |    |          |                           |   |    |          |             |   |    |
| UG1005B1  | LONG RAY ROTOR WATER NOZZL     | 1   | PZ         |                          |  |      |             |     |     |          |                              |   |    |          |                            |   |    |          |                           |   |    |          |                            |   |    |          |                            |   |    |          |                                |   |    |          |                      |   |    |          |                           |   |    |          |             |   |    |
| UG1006B3  | LONG RAY ROTOR WATER NOZZL     | 1   | PZ         |                          |  |      |             |     |     |          |                              |   |    |          |                            |   |    |          |                           |   |    |          |                            |   |    |          |                            |   |    |          |                                |   |    |          |                      |   |    |          |                           |   |    |          |             |   |    |
| VI1220A1  | 4,2X12 TCB SELF-TAPPIN G SCREW | 8   | PZ         |                          |  |      |             |     |     |          |                              |   |    |          |                            |   |    |          |                           |   |    |          |                            |   |    |          |                            |   |    |          |                                |   |    |          |                      |   |    |          |                           |   |    |          |             |   |    |
| VM1955C0  | WASHING SYSTEM ROTOR           | 1   | PZ         |                          |  |      |             |     |     |          |                              |   |    |          |                            |   |    |          |                           |   |    |          |                            |   |    |          |                            |   |    |          |                                |   |    |          |                      |   |    |          |                           |   |    |          |             |   |    |
| VM1985C1  | WASHING SYSTEM ROTOR COVE      | 1   | PZ         |                          |  |      |             |     |     |          |                              |   |    |          |                            |   |    |          |                           |   |    |          |                            |   |    |          |                            |   |    |          |                                |   |    |          |                      |   |    |          |                           |   |    |          |             |   |    |
| VM1986A0  | NOZZLE COVE                    | 2   | PZ         |                          |  |      |             |     |     |          |                              |   |    |          |                            |   |    |          |                           |   |    |          |                            |   |    |          |                            |   |    |          |                                |   |    |          |                      |   |    |          |                           |   |    |          |             |   |    |
| VL1037A   | WASHING SYSTEM ROTOR           |  | KVL1037A   | WASHING SYSTEM ROTOR KIT | <table border="1"> <thead> <tr> <th>Code</th> <th>Description</th> <th>Qty</th> <th>UOM</th> </tr> </thead> <tbody> <tr> <td>GN1416B0</td> <td>WASHING SYSTEM ROTOR BEARING</td> <td>1</td> <td>PZ</td> </tr> <tr> <td>TF1065B0</td> <td>WASHING SYSTEM ROTOR PIVOT</td> <td>1</td> <td>PZ</td> </tr> <tr> <td>TF1066A1</td> <td>WASHING SYSTEM ROTOR BUSH</td> <td>1</td> <td>PZ</td> </tr> <tr> <td>UG1005B1</td> <td>LONG RAY ROTOR WATER NOZZL</td> <td>1</td> <td>PZ</td> </tr> <tr> <td>UG1006B3</td> <td>LONG RAY ROTOR WATER NOZZL</td> <td>1</td> <td>PZ</td> </tr> <tr> <td>VI1220A1</td> <td>4,2X12 TCB SELF-TAPPIN G SCREW</td> <td>8</td> <td>PZ</td> </tr> <tr> <td>VM1955C0</td> <td>WASHING SYSTEM ROTOR</td> <td>1</td> <td>PZ</td> </tr> <tr> <td>VM1985C1</td> <td>WASHING SYSTEM ROTOR COVE</td> <td>1</td> <td>PZ</td> </tr> <tr> <td>VM1986A0</td> <td>NOZZLE COVE</td> <td>2</td> <td>PZ</td> </tr> </tbody> </table> | Code | Description | Qty | UOM | GN1416B0 | WASHING SYSTEM ROTOR BEARING | 1 | PZ | TF1065B0 | WASHING SYSTEM ROTOR PIVOT | 1 | PZ | TF1066A1 | WASHING SYSTEM ROTOR BUSH | 1 | PZ | UG1005B1 | LONG RAY ROTOR WATER NOZZL | 1 | PZ | UG1006B3 | LONG RAY ROTOR WATER NOZZL | 1 | PZ | VI1220A1 | 4,2X12 TCB SELF-TAPPIN G SCREW | 8 | PZ | VM1955C0 | WASHING SYSTEM ROTOR | 1 | PZ | VM1985C1 | WASHING SYSTEM ROTOR COVE | 1 | PZ | VM1986A0 | NOZZLE COVE | 2 | PZ |
| Code      | Description                    | Qty   | UOM        |                          |  |      |             |     |     |          |                              |   |    |          |                            |   |    |          |                           |   |    |          |                            |   |    |          |                            |   |    |          |                                |   |    |          |                      |   |    |          |                           |   |    |          |             |   |    |
| GN1416B0  | WASHING SYSTEM ROTOR BEARING   | 1   | PZ         |                          |  |      |             |     |     |          |                              |   |    |          |                            |   |    |          |                           |   |    |          |                            |   |    |          |                            |   |    |          |                                |   |    |          |                      |   |    |          |                           |   |    |          |             |   |    |
| TF1065B0  | WASHING SYSTEM ROTOR PIVOT     | 1   | PZ         |                          |  |      |             |     |     |          |                              |   |    |          |                            |   |    |          |                           |   |    |          |                            |   |    |          |                            |   |    |          |                                |   |    |          |                      |   |    |          |                           |   |    |          |             |   |    |
| TF1066A1  | WASHING SYSTEM ROTOR BUSH      | 1   | PZ         |                          |  |      |             |     |     |          |                              |   |    |          |                            |   |    |          |                           |   |    |          |                            |   |    |          |                            |   |    |          |                                |   |    |          |                      |   |    |          |                           |   |    |          |             |   |    |
| UG1005B1  | LONG RAY ROTOR WATER NOZZL     | 1   | PZ         |                          |  |      |             |     |     |          |                              |   |    |          |                            |   |    |          |                           |   |    |          |                            |   |    |          |                            |   |    |          |                                |   |    |          |                      |   |    |          |                           |   |    |          |             |   |    |
| UG1006B3  | LONG RAY ROTOR WATER NOZZL     | 1   | PZ         |                          |  |      |             |     |     |          |                              |   |    |          |                            |   |    |          |                           |   |    |          |                            |   |    |          |                            |   |    |          |                                |   |    |          |                      |   |    |          |                           |   |    |          |             |   |    |
| VI1220A1  | 4,2X12 TCB SELF-TAPPIN G SCREW | 8   | PZ         |                          |  |      |             |     |     |          |                              |   |    |          |                            |   |    |          |                           |   |    |          |                            |   |    |          |                            |   |    |          |                                |   |    |          |                      |   |    |          |                           |   |    |          |             |   |    |
| VM1955C0  | WASHING SYSTEM ROTOR           | 1   | PZ         |                          |  |      |             |     |     |          |                              |   |    |          |                            |   |    |          |                           |   |    |          |                            |   |    |          |                            |   |    |          |                                |   |    |          |                      |   |    |          |                           |   |    |          |             |   |    |
| VM1985C1  | WASHING SYSTEM ROTOR COVE      | 1   | PZ         |                          |  |      |             |     |     |          |                              |   |    |          |                            |   |    |          |                           |   |    |          |                            |   |    |          |                            |   |    |          |                                |   |    |          |                      |   |    |          |                           |   |    |          |             |   |    |
| VM1986A0  | NOZZLE COVE                    | 2   | PZ         |                          |  |      |             |     |     |          |                              |   |    |          |                            |   |    |          |                           |   |    |          |                            |   |    |          |                            |   |    |          |                                |   |    |          |                      |   |    |          |                           |   |    |          |             |   |    |